



CATALOGUE
2025



TABLE OF CONTENTS

REELS 4-125
 Reel technology 6-19, 96-97
 FW Spinning 21-55
 BR reels 57-63
 Big Pit reels 65-85
 SW Spinning 87-95
 Baitcast reels 99-111
 Conventional reels 112-119
 Spare spools..... 120-125

RODS 126-267
 Rod technology 130-131
 Spinning 132-189
 All-round 191-193
 Special trout rods..... 158-160
 180, 184, 190
 Seatrout rods 132, 146, 158
 164, 167, 177, 179, 265
 Catfish 148, 194-196
 Poles & Bolognese 198-201
 Carp 203-222
 Feeder 197, 224-237
 Coarse 238-239, 245
 Telescopic rods 173, 190, 198-201
 220-222, 237, 239-246, 265
 Seafishing 248-267

TT 268-341
 Braided lines 270-282
 Monofilament lines 283-291
 Hard lures 294-305
 Soft lures..... 306-307
 Seafishing 308-311

Accessories / Swivels 314-317
 Hooks 317-321
 Storage boxes 325, 334-337
 Tools 321, 324-325, 331
 Bags 328, 333, 338-341
 Landing nets..... 322-323, 329
 Umbrellas 329

CARP RANGE 342-357
 Bags / chairs/ bed chairs 344-349,
 354-356
 Landing nets..... 352-353
 Rod pods 357

CLOTHING 358-369



STEEZ 370-389



PRESSO 390-399



PROREX 400-465
 Spinning reels 404-406
 Baitcast..... 407-409

Rods 412-425
 Lines 426
 Hard lures 427-431
 Spinnerbaits etc. 434, 442, 445
 Soft lures..... 432-433
 435-439, 443-444
 Hybrid Swimbaits 440-441
 Accessories 444, 446-449, 454-456
 Pliers 456-457
 Landing nets..... 450-453
 Hoodies..... 465
 Bags / Storage 458-465



N'ZON 466-500
 Reels 470-473
 Rods 474-483
 Accessories 484-491, 495
 Landing nets, keep nets 492-495
 Bags, holdalls 496-500



ADVANTAGE BAITS 501-505

ALPHABETICAL INDEX

A
 Assist-Hooks 444, 446-447

B
 Bags 328-333, 338-341, 345-349
 354-355, 397, 458-465, 496-500
 Baitcast reels 99-111, 407-409
 Balance weights..... 495
 Bed chairs 356
 Big Pit reels 65-85
 Boots 367
 BR reels 57-63
 Braided lines 270-282, 426, 487
 Buckets..... 330, 497, 504

C
 Cage feeders..... 485-486, 488, 495
 Caps..... 365, 369
 Carp luggage 345-349, 354-355
 Carp range 342-357
 Carp reels 65-85
 Carp rods..... 203-222
 Catfish rods 148, 194-196
 Chairs..... 356, 488
 Clothing..... 358-369, 465
 Conventional reels 112-119
 Coregone rods..... 161

E
 Electric reels 112-116
 EVA bags 330, 346-347, 496-498

F
 Feeder rods 197, 224-237, 474-483
 Flotation suites 360
 Fluorocarbon 289-290, 426

H
 Hard lures 294-305, 374-383
 386, 427-431
 Hoodies..... 364, 366, 465
 Hooks..... 317-321, 388-389, 449

Holdalls..... 331-332, 338-340, 348-349
 354, 464-465, 500

J
 Jackets 363
 Jig heads..... 317, 449, 454
 Joggers..... 365

K
 Keepnets 493
 Knitted caps 368
 Knot tool „Sokkou“ 321

L
 Landing nets..... 323, 352-353, 398
 450-452, 492, 494
 Landing net poles..... 322, 329, 453, 495
 Leader material..... 289-291, 426, 487
 Lines 270-291, 426, 487

M
 Monofilament lines 283-291, 487

N
 Neckgaiter 368

P
 Plastic boxes 325, 334-337
 Pliers..... 324, 456-457
 Polo shirts 366

R
 Reel pouches 328
 Reels 21-119, 404-409, 470-473
 Rod bags 331-332, 338-340
 348-349, 354, 464-465, 500
 Rod pods 357
 Rod stand 399
 Rods 132-267, 412-425, 474-483
 Rubber boots 360

S
 Scales 325
 Scissors 325
 Seafishing rigs / Sabikis..... 308-311

Seafishing rods 248-267
 Snelled hooks 318-321
 Soft lures..... 306-307, 383-385
 387, 432-433, 435-439, 443-444
 Spare spools..... 120-125
 Spinner baits 434, 442, 445
 Spinning reels 21-55, 404-406, 470-473
 Spinning rods 132-189, 412-425
 Split rings 317
 Split ring pliers 324
 Spoons 394-396
 Steel wire 454-455
 Surfcasting rods 265-267
 Swivel..... 314-317, 455

T
 T-Shirts..... 364
 Tape measure 324
 Telescopic rods 173, 190, 198-201
 220-222, 237-239, 240-246, 265
 Tools 321, 324-325, 456-457, 490
 Towel 324
 Trout Special..... 158-160, 180
 184, 190

U
 Umbrellas 329, 489
 Unhooking mats..... 341, 350-351

W
 Waders 362-363
 Wading jacket 363
 Winter boots 360
 Winter clothing 360-361



Feel Alive.





REEL PROGRAM 2025





DAIWA TECHNOLOGY



MAG SEALED®

To prevent the penetration of water, dust particles or salt crystals between rotor and reel body as far as possible, we have developed a nearly frictionless barrier based on magnetic oil, which hardly can be overcome by neither water nor smallest particles. The result is a silky-smooth running.

MAG SEALED BODY DESIGN

In most cases, salt crystals and other solid particles are in charge for unpleasant winding noises as well as the loss of smooth running. Of course also „accidents“ can lead to a similar result. Despite these special cases, the cases with unpleasant winding noises are significantly decreased at reels with MagSealed, as depicted in the right figure.

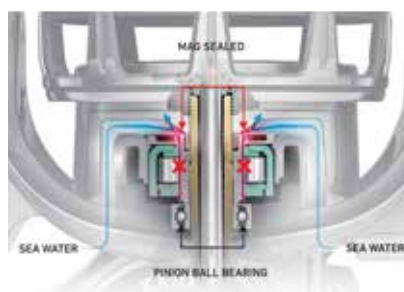

MAG SEALED LINE ROLLER

The smoother a line roller turns, the less friction emerges between line and roller. If delicate salt or dirt particles penetrate the line roller, it is continuously dragged and the friction is considerably increased.

The magnetic MagSealed oil forms a barrier, which prevents the intrusion of water and therefore also of salt and dirt particles into the line roller almost entirely, which could affect the free rotation.

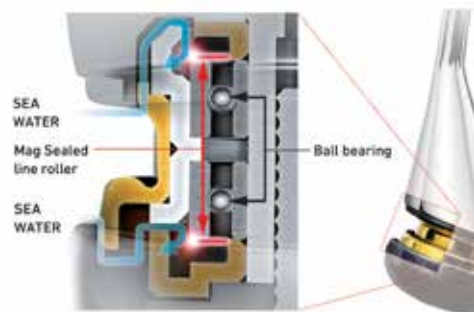

MAG SEALED Ball bearing

Our DAIWA technology further on changes the fishing tackle market. Our engineers succeeded in further devolving the MagSealed invention to a new level. First we sealed the axis to the greatest possible extent, then the line roller and now the ball bearing! MagSealed is a latest chapter in the history of the fishing reel. Thanks to our targeted research and development, we succeeded in integrating MagSealed into a ball bearing. **For a long lifespan and a silky-smooth running over a long period. A revolution!**

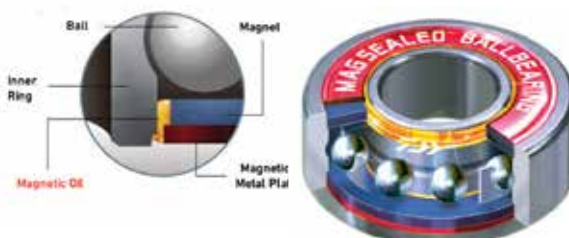



SOME OF THE NEW TECHNOLOGIES

CROSS WRAP®



Wraps the line precisely on the spool and reduces the threat of backlashes at the cast. The casting distance is markedly increased.

Seamless Air Bail®



The novel seamless Air Bail concept leads the line straight to the line roller at a more compact and lighter design at the same time.



New line clip

This line clip is suited for all kind of lines and diameters. By its special design it further reduces the weight of the innately lightweight LT spools.



2 ball bearing line roller

Since the direction of force changes permanently at the line roller, an attachment at 2 points is inevitable – at the LT we use 2 ball bearings below the line roller.



ZAION® AIRROTOR®

Reduces the starting resistance at the rotor and offers optimum sensitivity – at reduced weight and extreme toughness.



Hi-Grip handle knob

The latest T-Type handle knob is extremely light and thanks to the Hi-Grip material very pleasant to handle, even with wet fingers.



THE BASE OF THE DAIWA REEL TECHNOLOGY

AIR ROTOR®

The magnetic oil barrier does not only prevent the intrusion of water, it also increases the ease of motion and the delicacy of feeling of the reel. You feel better connected to the lure, detect softer bites and experience more sensitivity during the fight with the fish. Especially for this new feeling we developed the Air Rotor. First, the enormous strains, which affect the rotor via the line and the line roller are better distributed. This causes less pressure on the single parts of the rotor. Second, the new rotor is 15% more light weighted than usual rotors of the same material - this reduces vibrations and enhances the rotational balance thanks to a very low center of gravity.

Comparison of distortion-proofness



Air Rotor

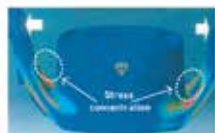

Conventional Rotor



Under the same strain, a conventional rotor is much more distorted than an Air Rotor, since here the strain is scattered over the whole rotor and not concentrated to one point.

ZAION®

Zaion is an excellent material developed by DAIWA to built reel bodies and rotors. The big advantage of this material is its lightness and solidity - you will feel this. Zaion is a kind of „High Density“ carbon strain material, which is made for highest performance and to resist maximum impact. Due to Zaion, it is possible to construct a lightweight reel body that durably supports the gearing. The strength of Zaion corresponds to magnesium and is 20% stronger than Nylon/ABS material, usually used for reel bodies. Zaion is about 50% lighter than aluminium.



ZAION V

With the Zaion V material, the Japanese DAIWA engineers succeeded in developing a combination of materials, which can be used more conveniently in processing and producing reels compared to the previously existing Zaion material. Thus it also can be used in more economic reel series.

Due to the high amount of carbon fiber and a new composite material the new Zaion V is significantly lighter and more distortion proof than common D55 material.

AIRBALL®



The Air Bail reel handle is hollow and thus very lightweight, extremely strong and exceptionally resilient. The special, strengthening construction prevents the twisting of the line around the bail, which was a big problem for spin anglers in the past.



DAIWA's original advanced technology designed to reduce line twist during retrieving. An essential reason for line twist has been eliminated with this smart idea. The Twist Buster II line roller not only minimises line twist, but also reduces further friction between the line and the roller.

AIRMETAL®



Reels featuring a magnesium body and rotor are excelled by their drastically reduced weight compared to conventional aluminum reels. Our Air Metal technology processes the magnesium in a special way, leading to full corrosion resistance, which would be not possible without this special processing. Thus, you can enjoy a DAIWA Air Metal magnesium reel also at salt water fishing.

HardBodyz®
Light & Rigid Metal Construction



We have the perfect metal alloy, we have the more precise processing and we have the knowledge for building precise, durable and very lightweight metal reels.

We call this technology the HardBodyZ Concept. These reels have many technological advantages and they are not – compared to other synthetic reels – more expensive and in comparison to our traditional reels they have an economic price!

DIGIGEAR®



Machined, digitally developed gearing for maximum performance and endurance. It smoothly and efficiently transmits the power of the handle directly to the rotor.

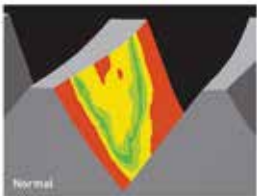
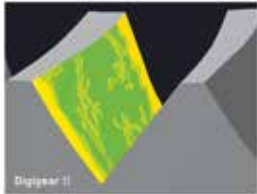

Our DAIWA engineers completely perfected the technology of milled gears with the Digigear II. The shape and surface of the gear teeth enable the construction of gears with extraordinary smooth running, smallest resistance and extremely long lifespan.



ABS®

ANTI-BACKLASH SYSTEM

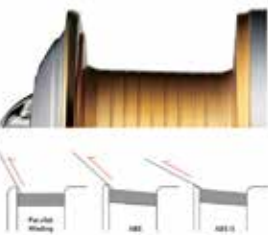

The super system that allows long casts and prevents line twist reliably. DAIWA reels with ABS have spools, which are constructed in such way that they have a spool guide of a very large diameter which is getting bigger towards the spool's top. Like this the line unwinds in big loops and very evenly from the spool and thus prevents the twisting of the line. Thanks to this system also longer casts are possible.

U.T. Drag®



The Ultimate Tournament Drag System includes impregnated drag discs, which are about 30 times more durable than normal discs. The effective drag power is considerably increased compared to normal drag systems. An additional advantage is the reduced start-up resistance – the drag starts working, when the adjusted drag power is reached and drags smoothly and steadily.

ATD™



ATD stands for the further development of the UTD drag.

The ATD drag is excelled by an even more delicate drag transition and as a consequence thereof is perfectly suited for the use of braided lines. Contrasting to the UTD drag, at the ATD already at the beginning of a strike the drag starts smoothly, then increases to its pre-set drag rating in a fraction of a second, thus eliminating line breakage at the strike.

SILENT OSCILLATION®



By the special position and bearing of the oscillation-gear wheels, we improved the smoothness of the gear in comparison to usual systems of similar construction.

INFINITE®

ANTI-REVERSE



A weak part of many reels – the most reliable part of a DAIWA reel. Only high-quality parts made of steel with smallest tolerances are used.

CRBB®



CRBB is short for Corrosion Resistant Ball Bearings and means salt-water-proof, stainless ball bearings. CRBB ball bearings feature an 12 times higher corrosion resistance than usual ball bearings.



DAIWA continues to live its dream of developing revolutionary fishing reels: Fishing reels with low weight and easy handling, which appear like a genuine part of the body at fishing. Producing fishing reels tough enough, to withstand even harshest conditions.

The combination of these two prerequisites is the accomplishment of „Light & Tough“. Now, after a long history of new challenges this dream has come true.

We are proud to present you the „Light & Tough“ concept.



Introducing 'minimalist engineering' in DAIWA spinning reels. LT Technology introduces new, reduced reel dimensions but makes them stronger than ever. Compact body design yet with tougher Digigear drive for the perfect combination of lightness and toughness. Pick one up and feel it for yourself.



6 Tasks had to be solved to make our reels lighter, more compact and more powerfull. This is the principle of our new LT (Light&Tough) construction

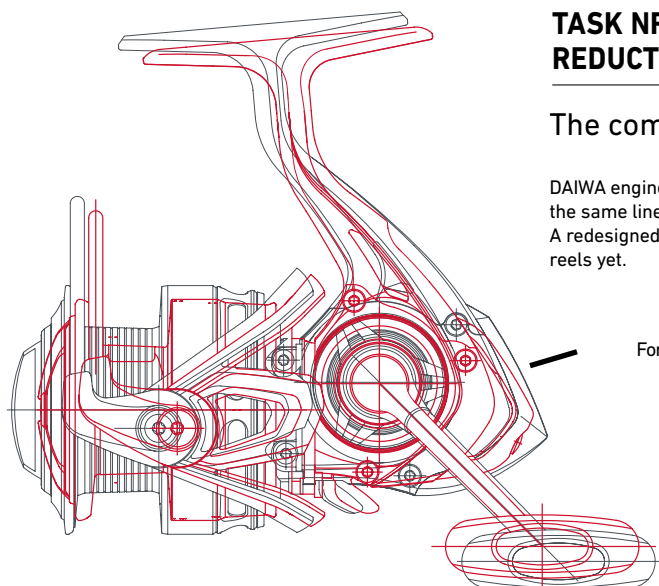

**TASK NR. 1:
REDUCTION OF THE DIMENSIONS**

The compact construction

DAIWA engineers set out to eliminate unnecessary weight without sacrificing strength and keeping the same line capacity.
A redesigned, smaller profile throughout with a tougher gear makes LT our lightest and toughest reels yet.

Former body size

**COMPACT
TOUGH
LIGHT
ROBUST**

TASK NR. 2: LIGHTER AND STRONGER REEL BODY

ZAION & DS5

Zaion and DS5 are incredibly strong carbon based composite materials developed by DAIWA TECHNOLOGY. Carbon composite will make the reels lighter and tougher than ordinary materials. And as they are not metal, they never corrode, even in salt water use. Light, tough and highly durable - the perfect materials for long lasting reels.

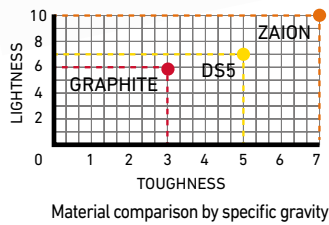
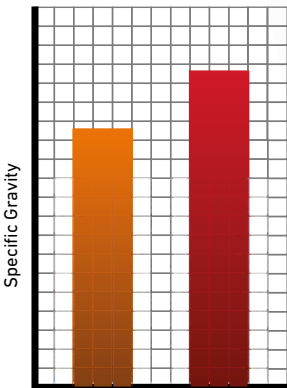

TASK NR. 3: STRONGER DRIVE GEAR

The TOUGH DIGIGEAR

Keeping the merits of Digigear, we considered how to make the gear tougher than ever. We studied all aspects; diameter, thickness, teeth shape and size.



We experimented and tested everything one by one, refining and improving each element. The result is a leap in the level of Digigear toughness.



TASK NR. 4: STRONGER DRAG POWER

The ATD Drag



We have combined a variety of improvements; internal spool support, shaft construction and drag knob surface area to toughen and enhance even further what ATD delivers.

LT reels provide an astonishing level of improved max. drag power, even so they are reduced in size and lightweight.



TASK NR. 5: LIGHTER ALUMINUM SPOOLS

The Aluminum Air Spool

By completely reconsidering the spool shape, size and thickness we achieved a drop in spool weight, creating a very light aluminium spool. This is lighter than our current Air Spool made from ABS, and noticeably enhances the reel balance.



TASK NR.6: LIGHTER HANDLES

The LT Handle

Keeping the required level of strength and durability for fishing, we reshaped and refined the handle arm. This new design contributes to the reel's superior light weight.





SERIES NAME

LT 2500 **D** - **C** **XH** Indication on spool

Type of spool

2500D Deep spool (indication D = deep)
2500 Semi-shallow spool (without indication)
2500S Shallow spool (indication S = shallow)

Compact body model

2500C Compact body (small body - big spool) Indication „C“

Gear ratio

2500P Power gear ratio 4.9:1
2500 Standard gear ratio 5.0:1 to 5.4:1
2500H High gear ratio 5.5:1 to 5.9:1
2500XH Super high gear ratio 6.0:1 and higher

Some examples

LT 3000 D - C XH
 Size 3000 with deep spool, compact body and high gear ratio of 6.0:1
LT 1000
 Size 1000 with semi-shallow spool and normal gear ratio from 5.0 to 5.4:1
LT 2000 H
 Size 2000 with semi-shallow spool and high gear ratio from 5.5 to 5.9:1

LINE CAPACITY LT REELS

Size	Spool	m/mm Monofilament	m/mm Braided	PE
LT1000	LT1000D	150m / 0.20mm	~300m / ~0.06mm	PE 0.6
	LT1000	150m / 0.14mm	~200m / ~0.05mm	PE 0.4
	LT1000S	100m / 0.12mm	~200m / ~0.04mm	PE 0.3
LT2000	LT2000D	150m / 0.23mm	~300m / ~0.08mm	PE 0.8
	LT2000	150m / 0.16mm	~200m / ~0.06mm	PE 0.6
	LT2000S	150m / 0.14mm	~200m / ~0.04mm	PE 0.3
LT2500	LT2500D	150m / 0.28mm	~300m / ~0.14mm	PE 1.2
	LT2500	150m / 0.20mm	~200m / ~0.08mm	PE 0.8
	LT2500S	150m / 0.16mm	~200m / ~0.06mm	PE 0.6
LT3000	LT3000D	150m / 0.33mm	~300m / ~0.16mm	PE 1.5
	LT3000	150m / 0.23mm	~200m / ~0.13mm	PE 1.0
	LT3000S	150m / 0.20mm	~200m / ~0.08mm	PE 0.8
LT4000	LT4000D	150m / 0.37mm	~300m / ~0.20mm	PE 2.0
	LT4000	150m / 0.28mm	~200m / ~0.16mm	PE 1.5
	LT4000S	150m / 0.23mm	~200m / ~0.13mm	PE 1.0
LT5000	LT5000D	150m / 0.40mm	~300m / ~0.22mm	PE 2.5
	LT5000	150m / 0.37mm	~300m / ~0.20mm	PE 2.0
	LT5000S	150m / 0.28mm	~200m / ~0.16mm	PE 1.5
LT6000	LT6000D	150m / 0.43mm	~300m / ~0.26mm	PE 3.0
	LT6000	150m / 0.40mm	~300m / ~0.22mm	PE 2.5
	LT6000S	150m / 0.37mm	~300m / ~0.20mm	PE 2.0

We did not only develop the LT Concept,
 the TOUGH DIGIGEAR, the AIR BAIL, AIR ROTOR
 and ZAION - but also the MONOCOQUE body.



MONOCOQUE Body



The MONOCOQUE BODY design

Light and strong like a Formula 1 racing car. Lighter and stronger through Monocoque Body technology.

Since the first spinning reels it was common sense that the body is made up of two parts: The reel body and the body lid. With its introduction 2016 the Monocoque body design simply crushed this long-standing paradigm. At the Monocoque design, the reel body serves as a stiff and distortion-proof frame, which is handy and compact at the same time. Thus the body lid has no longer to be secured with a screw and the resulting free space can be used for a larger driving wheel. By this design, the reel body can house a driving wheel, which diameter is about 85% of the body surface. To put it simple: This design allows the use of larger and thus stronger driving wheels at the same body size.



Features LT spinning reels

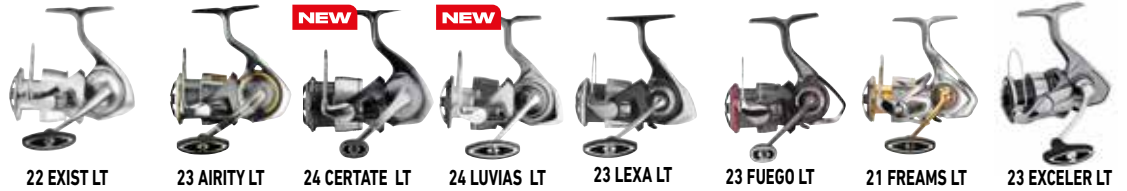

	22 EXIST LT	23 AIRITY LT	24 CERTATE LT	24 LUVIAS LT	23 LEXA LT	23 FUEGO LT	21 FREAMS LT	23 EXCELER LT
LT (Light & Tough)	●	●	●	●	●	●	●	●
AIR METAL reel body	●	●						
ZAION V® reel body						●	●	●
ZAION® reel body				●				
Aluminum reel body			●		●			
MONOCOQUE® body	●	●	●	●				
MAGSEALED® body	●	●		●	●	●	●	
MAGSEALED® ball bearing	●		●					
MAGSEALED® line roller	●	●	●					
CRBB® ball bearing	●	●		●				
AIR ROTOR®			●				●	
AIRDRIVE® ROTOR	●	●	●	●	●	●		●
AIRDRIVE® SPOOL	●	●	●	●	●			
AIRDRIVE® SHAFT	●	●	●	●				
AIRDRIVE® BAIL	●	●		●	●	●		●
ZAION V® AIR Rotor®					●		●	
ZAION® AIR Rotor®			●					
One-piece AIRBAIL®	●	●		●				
AIRBAIL®							●	
ATD™ Drag			●				●	
ATD™ Type-L Drag	●	●	●	●	●	●		●
Infinite Anti-Reverse®	●	●	●	●	●	●	●	●
Machined TOUGH DIGIGEAR®	●	●		●				
TOUGH DIGIGEAR®			●		●	●	●	●
Machined Aluminium handle	●	●	●	●	●	●	●	●
Cold forged Aluminium spool	●	●		●	●	●	●	●
Twist Buster® II			●				●	
Twist Buster® III	●	●	●	●	●	●		●
Made in Japan	●	●						

Features LT special reels



	24 N'ZON PLUS LT	20 N'ZON LT	24 PROREX-X LT	21 PROREX-MQ LT	22 PROREX-V LT	23 NINJA MATCH & FEEDER LT
LT (Light & Tough)	●	●	●	●	●	●
ZAION® reel body						
Aluminum reel body	●					
DS5 reel body						
CRBB® ball bearings	●			●		
MONOCOQUE® Body				●		
ZAION V® reel body				●		
AIR Rotor®		●		●	●	
AIR BAIL®				●	●	
QD® drag system	●					
ATD™ drag system		●		●	●	
Infinite Anti-Reverse®	●	●	●	●	●	●
CNC-cut TOUGH DIGIGEAR®						
TOUGH DIGIGEAR®		●	●	●	●	●
Machine-cut aluminum handle	●		●	●	●	●
One-Touch handle		●				
Cross Wrap® system		●		●	●	●
Aluminum Air spool		●	●	●	●	●
Silent Oscillation® system		●		●	●	
Twist Buster® II line roller		●		●	●	
New Shape line stopper		●		●	●	



Be strong, no limit.

CERTATE

AIRDRIVE
DESIGN



AIRDRIVE DESIGN

Powered by EXIST



ROTATION LIKE YOU HAVE NEVER FELT BEFORE.

The future of DAIWA Spinning Reels is AIRDRIVE Design.

By reducing the weight of rotor, spool & bail assembly, a lighter rotation is achieved.

The effortless rotation allows the angler to feel the true joy of trouble free function.

This new chapter starts with 22' Exist.

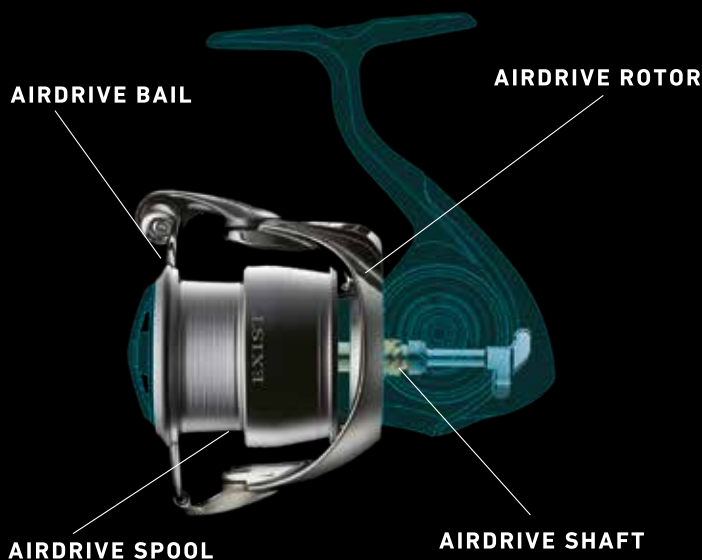

CONSEQUENCES OF THE AIRDRIVE DESIGN

Reel balance improvement

16% lighter front unit compared to the 18' Exist (#2500). Optimization of weight and balance enable improved control at fishing.

Rotation improvement

The sensitivity and responsiveness of the reel has seen significant improvement. Low inertia allows anglers to experience a quick reaction and smooth running. The new AIRDRIVE rotor instantly starts and elevates the control.

Less line trouble

By combining the benefits of AIRDRIVE Rotor & AIRDRIVE Bail, along with Twistbuster III technology, the 22' Exist is the easiest to manage spinning reel of all times created by DAIWA!

ATD | TYPE - L



ATD Type-L
The second generation of the ATD drag system. Works smoother and delivers the adjusted drag power almost without any inertia. The drag clicker sound has also been improved.

[DRAG CONSISTENCY]

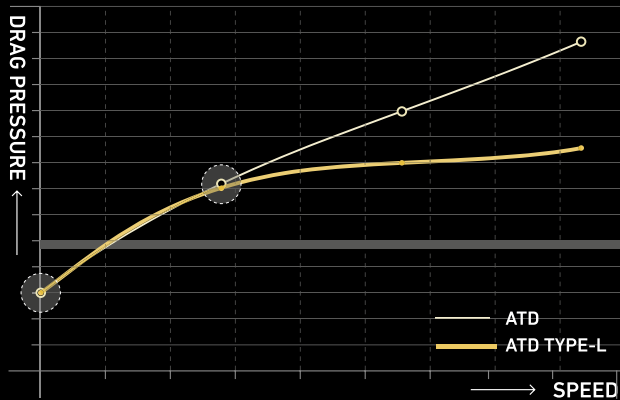

[START UP DRAG RESISTANCE]

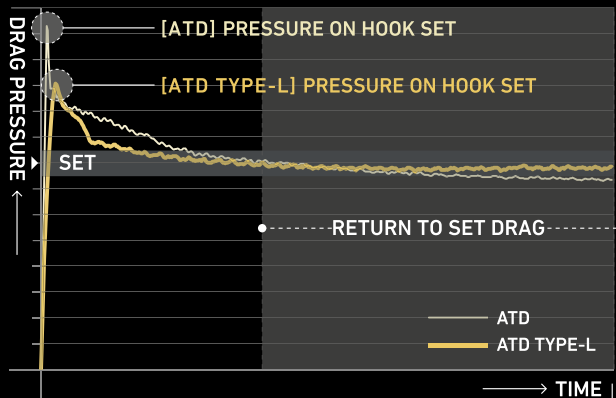

TWISTBUSTER III



TWISTBUSTER III
With the 22' Exist DAIWA has managed to improve the existing Twistbuster II and introduce the technology Twistbuster III. By adding another groove on the line roller, itself, the flattening effect of the line when retrieved is reduced and this as a result decreases line twist. DAIWA has also installed Magsealed Line Roller to negate the harsh effects of saltwater and maintain performance long term.

AIRDRIVE SPOOL



DESIGN REFLECTS THE FUTURE.
The stand out features of the AIRDRIVE Spool would have to be the newly shaped spool skirt and the simple single silver coloured cosmetic. Just by looking at the spool it is clear the structure has been redeveloped, reducing the weight and maximising the feeling of presence. Reducing the spool weight creates many benefits for a reel; the total weight of reel is reduced, oscillation is improved, less resistance during winding and rotation, better balance when attached to the rod and of course the reel feels light and easy to fish. In addition, DAIWA has added a skirt to the bottom of the spool edge to prevent line getting caught behind the spool and tangling with the main shaft.

The drag sound and clicker has also been redesigned to create a higher pitch drag sound.

AIRDRIVE SHAFT



FRICTION FREE ROTATION.
Vertical rotational force from the handle is converted by the pinion gear to horizontal rotation. The mainshaft goes through the pinion gear to support the oscillation of the spool. To create a smoother oscillation and rotation, improvement to the mainshaft and pinion gear was required. Most DAIWA spinning reels use linear shaft which has a non contact structure between the mainshaft and the pinion gear itself. The linear shaft creates less friction resistance which leads to smoother rotation along with minimal power loss. The newly developed AIRDRIVE Shaft has taken the same benefits and improved further. AIRDRIVE Shaft also has a non contact structure between the mainshaft and the pinion gear. In addition to this, both ends of pinion gear are now supported with bearings to relay the crank power from the handle to the rotor with a higher level of efficiency. AIRDRIVE Shaft creates the feel of smooth, quiet rotation and provides anglers with torque and power.

AIRDRIVE ROTOR



LOW INERTIA IS THE KEY.
A lighter rotor increases the functionality of small spinning reels. The lighter and more compact rotor will require less initial force to rotate, creating that feeling of low inertia and effortless start up. The new AIRDRIVE rotor is made of Zalon. The robustness is the same as at the 18' Exist but nevertheless DAIWA was able to reduce the weight of the 22' Exist significantly. The goals during the development were to ensure an extremely light and smooth running. The rotor weight has been reduced by 16% compared to the previous edition (#2500) and sets a new benchmark regarding rotor design.

AIRDRIVE BAIL



TROUBLE FREE FUTURE.
DAIWA's well known technology AIR BAIL has seen further improvement with the concept of AIRDRIVE. The AIRDRIVE bail is the next evolutionary step in bail design and perfectly matched with the new AIRDRIVE concept. DAIWA succeeded in designing a somewhat thinner bail that nevertheless offers the required strength and further decreases the reel weight. Compared to the 18' Exist the new AIRDRIVE bail reduces the weight by 33% (Size 2500). Creating the bail in a smaller diameter reduces weight to create stress free and user-friendly fishing experience. DAIWA has adjusted the angle of bail setting to improve the line movement into the roller. The adoption and redesign of the bail was an essential prerequisite to archive an optimal design of the AIRDRIVE rotor.



EXIST



22 EXIST LT

SPINNING REEL

**AIRDRIVE
DESIGN**

MQ

MAGSEALED

ATD
AUTOMATIC DRAG SYSTEM

22' Exist LT – The future of modern reel technology!

The novel Airdrive design paves the way for DAIWA's future reel technology and offers smooth running and sensitivity you have never experienced before. Due to reduced weight of rotor, spool and bail, a softer rotation without starting resistance is enabled, which guarantees an optimally smooth running.

The 22' Exist is the first reel within the DAIWA range, which is equipped with the latest Airdrive concept. The reduction of the rotor's weight ensures you need less effort for starting, as well as faster stopping and thus quicker responses to different retrieving situations.

We reduced wall thickness as well as unnecessary weight within the Airdrive spool – in combination with the reduced weight of the rotor and the bail, this improves the reel balance and thus enables better lure control.

In contrast to common spinning reels, DAIWA developed a Low-Contact structure between axis and pinion gear – the Airdrive Shaft. Due to implementing this technology, friction gets reduced and the super soft and silent running is optimized.

The Airdrive concept is a combination of these elements, which enables the construction of extremely-lightweight and sensitive spinning reels.

The Airdrive bail is the next evolutionary step within bail design and assimilates perfectly to the Airdrive concept. DAIWA constructed a somewhat slimmer but nevertheless loadable bail which additionally reduces weight at the reel's front. Compared to the 18' Exist, the weight of the latest Airdrive bail is reduced by 33%.

The Twist Buster technology reduces the threat of burdensome line tangling and twist. For the 22' Exist, the well-known Twist Buster II technology has been further improved to the Twist Buster III construction. Due to the new construction the compression of the line during retrieving is reduced, which results in significantly less twist.

Additionally, a MagSealed line roller has been integrated within the 22' Exist, to enduringly resist highest strains even when used at sea fishing.



- AIRDRIVE Design
- MQ® Monocoque magnesium reel body
- MagSealed® body construction
- 12 ball bearings (incl. 10 CRBB® & 2 MagSealed® BB)
- ZAION® AIRDRIVE ROTOR
- CNC-machined TOUGH DIGIGEAR®
- AIRDRIVE Shaft
- Infinite Anti-Reverse®
- ATD™ Type-L drag system
- AIRDRIVE Spool
- AIRDRIVE BAIL
- MagSealed® Twist Buster® III line roller
- Made in Japan



Equipment:

Sizes 2500 to 4000 are equipped with T-Shape handle knob, the smaller size 2000 contains an I-shape handle knob. Size 5000 contains a round aluminum handle knob.

Art.-No.	Size	BB MSBB	BB CRBB	BB total	Capacity m/mm	Ratio	Retrieval cm	Drag kg	Weight g
10102-200	2000D-P	2	10	12	150/0.23	4.9:1	64	5.0	150
10102-251	PC 2500D-H	2	10	12	150/0.28	5.7:1	80	10.0	170
10102-252	PC 2500D	2	10	12	150/0.28	5.2:1	73	10.0	170
10102-255	2500	2	10	12	150/0.20	5.1:1	72	5.0	160
10102-300	3000D	2	10	12	150/0.33	5.2:1	77	10.0	175
10102-301	3000-H	2	10	12	150/0.23	5.7:1	85	10.0	175
10102-401	4000D	2	10	12	150/0.37	5.2:1	82	10.0	200
10102-402	4000-XH	2	10	12	150/0.28	6.2:1	99	10.0	200
10102-500	5000D-C	2	10	12	150/0.40	5.2:1	87	10.0	215



AIRITY



LIGHTEST
REEL
IN DAIWA HISTORY

AIRDRIVE
DESIGN

23 AIRITY LT

SPINNING REEL

AIRDRIVE
DESIGN

MQ

ATD | TYPE-L

The most lightweight reel by DAIWA – with Airdrive design!

The 23' Airity features all components of the new Airdrive design concept and provides highest sensitivity and smooth functioning. The CNC cut driving wheel has been coated with a special procedure to enable an even smoother and softer running. By the Airdrive Shaft a low-contact structure is formed at the pinion gear, further reducing the friction at the axis, leading to a silky-smooth and almost completely silent running, which is maintained permanently. The Monocoque design of the magnesium reel body allows the use of a larger gear with improved power transmission and elevated lifespan under high strains. The distortion-proof reel body cares for an optimal housing of the gear unit and permanent smooth running.

The novel Airdrive rotor contributes to a weight reduction in the front part of the reel and improves the balance of reel a rod – a better casting performance and an optimized lure control with incredible sensitivity are the result. By reducing the weight of the rotor, the rotor works with lower starting resistance, resulting in even more instant reactions possible. The novel hollow Airdrive bail represents an evolutionary step in bail design. More lightweight than the recent DAIWA bails but nevertheless tough enough for years of reliable service.

The wall thickness at the extra-lightweight Airdrive spools have been further reduced to eliminate further unnecessary weight – additionally contributing to a weight reduction at the front part of the reel. The Twistbuster III design at the line roller is perfect for the use of braided lines: it doesn't get compressed during retrieving and less twist is the result. Especially at fishing in salty waters the Magsealed design at the axis and the line roller help to reduce issues with corrosion and dirt particles.

- AIRDRIVE Design
- MQ® Monocoque magnesium reel body
- ZAION® AIRDRIVE ROTOR
- CNC-machined DIGIGEAR®
- AIRDRIVE Shaft
- ATD™ Type-L drag system
- AIRDRIVE ABS® longcast spool
- AIRDRIVE BAIL
- Twist Buster® III line roller
- Made in Japan



Equipment:

Ball bearings

The Airity LT reels with sizes 2000 to 2500S are equipped with in total 11 ball bearings, of these 9 CRBB ball bearings. Sizes PC2500 to 5000 in total features 11 CRBB ball bearings.

Handle knob

Sizes 2000 to 2500 are equipped with I-Shape handle knob, sizes 3000 to 4000 feature a T-Shape handle knob. Size 5000 features a round aluminum handle knob.

Art.-No.	Size	BB CRBB	BB total	Capacity m/mm	Ratio	Retrieval cm	Drag kg	Weight g
10001-201	2000S-H	9	11	150/0.14	5.8:1	76	5.0	145
10001-203	2000S-P	9	11	150/0.14	4.9:1	64	5.0	145
10001-250	2500S	9	11	150/0.16	5.1:1	72	5.0	150
10001-251	PC 2500	11	11	150/0.20	5.2:1	73	10.0	165
10001-252	PC 2500-H	11	11	150/0.20	5.7:1	80	10.0	165
10001-300	3000-H	11	11	150/0.23	5.7:1	85	10.0	175
10001-351	PC 3000	11	11	150/0.23	5.2:1	77	10.0	185
10001-400	4000-XH	11	11	150/0.28	6.2:1	99	10.0	200
10001-500	5000D-CXH	11	11	150/0.40	6.2:1	105	10.0	205



Be strong, no limit.

CERTATE

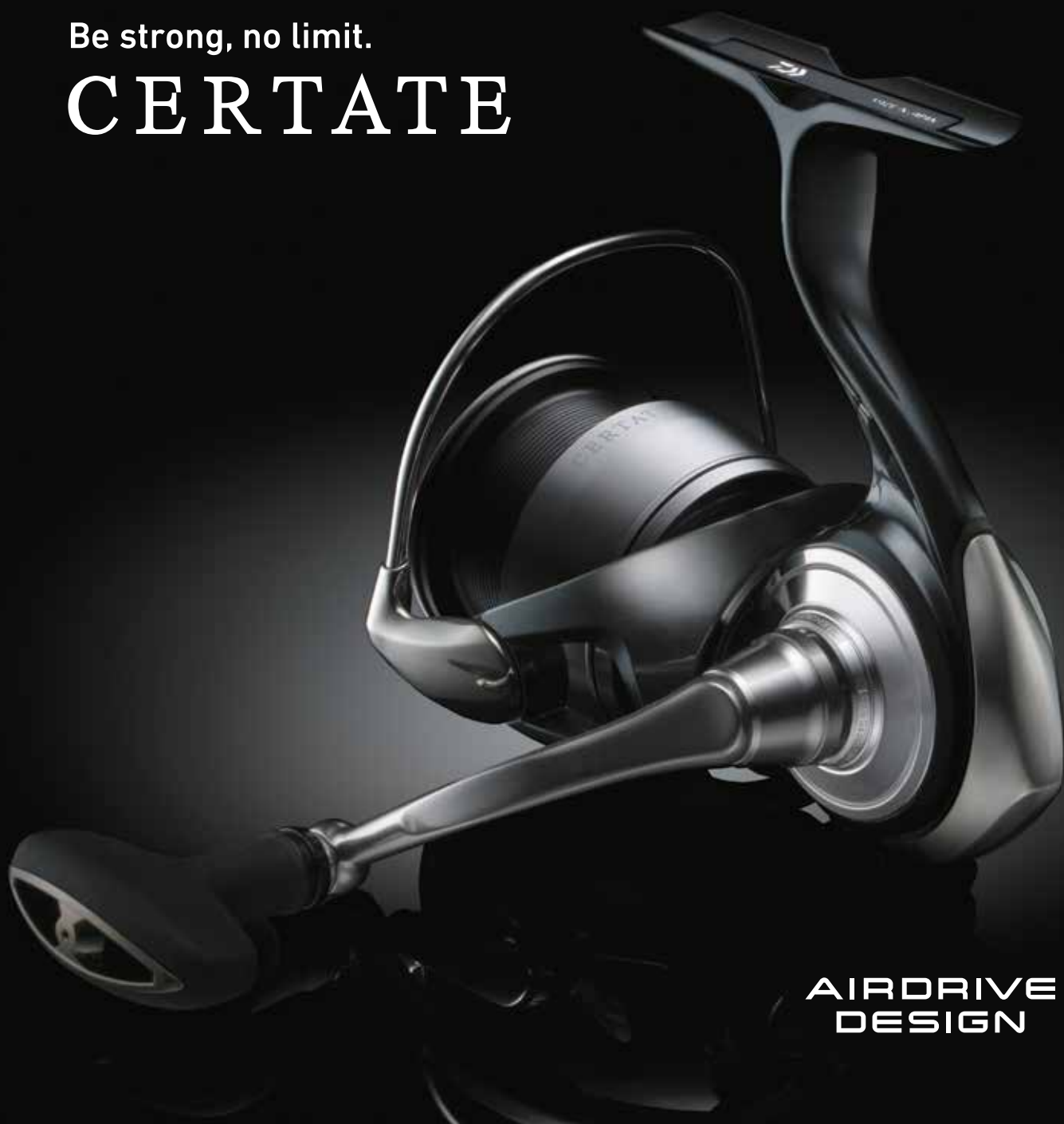

**AIRDRIVE
DESIGN**

24 CERTATE LT

NEW 🐟

SPINNING REEL

AIRDRIVE DESIGN **MQ** **MAGSEALED** **ATD | TYPE-L**

24 Certate – Be strong, no limit.

Features DAIWA's latest technology – Airdrive Design. Evolution of LT and Real Four, providing ultimate control.

Airdrive Design is the next generation of spinning reel design concept. The 24 Certate implements this cutting-edge technology in the front unit, providing anglers with superior operability with maximum power and rigidity.

The full metal monocoque body made of aluminium symbolizes the strength that no other reels can provide. An identity that has earned Certate the trust of wide range of anglers over the years.

The desire to be strong and tough wherever possible made the 24 Certate even stronger. Special surface treatment has been added to increase the hardness of the drive gear and water resistance has been improved on the handle side. In addition, the drags and pinions of some of the larger models are reinforced to Saltiga equivalent specifications. The combination of the light weight Airdrive Spool with tangle free new Airdrive Rotor and Airdrive Bail and the low friction Airdrive Shaft will provide you with an outstanding and innovative craftsmanship that you can use with absolute confidence.



- AIRDRIVE Design
- MQ® Monocoque aluminum reel body
- MagSealed® body construction
- 10 CRBB® ball bearings
- ZAION® AIRDRIVE ROTOR
- TOUGH DIGIGEAR®
- AIRDRIVE Shaft
- Permanent Infinite Anti-Reverse®
- ATD™ Type-L drag system
- Cross Wrap® system
- AIRDRIVE ABS® longcast spool
- AIRDRIVE BAIL
- Twist Buster® III line roller
- CNC-machined aluminum handle
- Made in Japan



Equipment:

Sizes FC 2000-P and FC 2500 are equipped with I-Shape handle knob, sizes 2500D to 4000D-CXH feature a T-Shape handle knob. Size 5000D features a round EVA handle knob.

The two smaller FC models 2000-P and 2500 do not feature a MagSealed line roller.

The FC (Finesse Custom) models are made as light as possible by using smaller body sizes and light weight components such as I-Shape handle knob and ultra-light aluminium handle and feature perfect balance with lightweight rods and lines.

Art.-No.	Size	BB CRBB	BB total	Capacity m/mm	Ratio	Retrieval cm	Drag kg	Weight g
10424-200	FC 2000-P	10	10	150/0.16	4.9:1	64	5.0	170
10424-250	FC 2500	10	10	150/0.20	5.1:1	72	5.0	175
10424-251	2500D	10	10	150/0.28	5.2:1	73	10.0	205
10424-252	2500D-H	10	10	150/0.28	5.7:1	80	10.0	205
10424-300	3000D-C	10	10	150/0.33	5.2:1	77	10.0	205
10424-301	3000D	10	10	150/0.33	5.2:1	77	10.0	225
10424-400	4000D-C	10	10	150/0.37	5.2:1	82	12.0	235
10424-401	4000D-CXH	10	10	150/0.37	6.2:1	99	12.0	235
10424-500	5000D	10	10	150/0.40	5.2:1	87	12.0	290



LUVIAS



24 LUVIAS LT

NEW

SPINNING REEL

**AIRDRIVE
DESIGN**

ATD | TYPE-L

MQ

Lighter, more sensitive and powerful!

The 24 Luvias LT fully impresses with its low weight and silky-smooth rotation. The combination of the innovative Airdrive Design with the special surface treated Tough Digigear takes the 24 Luvias to the next quality level.

The lightweight Airdrive rotor shifts the centre of gravity to the rear unit of the reel and provides considerably better balance and sensitivity – perfect for fishing with light tackle! The hollow Airdrive Bail reduces the risk of line tangles on the completely redesigned bail arm. The Airdrive Shaft is supported on the pinion gear by two ball bearings to virtually create a no contact structure reducing friction and ensures incredibly good sensitivity once retrieving. The extra-large MQ drive gear has received a special surface treatment that provides more durability and smoother rotation. The Monocoque body made of Zaiion material is extremely light and torque free to ensure perfect location of the inner gear unit.

For the handle shaft, a newly designed rubber seal was designed that significantly reduces ingress of rain or splash water via the handle.

- AIRDRIVE Design
- ZAIION® MQ® Monocoque reel body
- Aluminum body cover
- MagSealed® body construction
- 9 ball bearings
- ZAIION® AIRDRIVE ROTOR
- TOUGH DIGIGEAR®
- AIRDRIVE axis
- ATD™ Type-L drag system
- AIRDRIVE ABS® longcast spool
- AIRDRIVE BAIL
- Twist Buster® III line roller



The Power Custom (PC) models feature a larger body than the normal LT Reels.

Art.-No.	Size	BB CRBB	BB total	Capacity m/mm	Ratio	Retrieval cm	Drag kg	Weight g
10214-100	1000D	4	9	150/0.20	5.1:1	64	5.0	145
10214-200	2000D	4	9	150/0.23	5.1:1	67	5.0	145
10214-250	2500S	4	9	150/0.16	5.1:1	72	5.0	150
10214-251	PC 2500	5	9	150/0.20	5.2:1	73	10.0	170
10214-252	PC 2500D	5	9	150/0.28	5.2:1	73	10.0	170
10214-301	3000D	5	9	150/0.33	5.2:1	77	10.0	175
10214-302	PC 3000	6	9	150/0.23	5.2:1	77	10.0	205
10214-401	4000D	6	9	150/0.37	5.2:1	82	12.0	220
10214-500	5000D-C	6	9	150/0.40	5.2:1	87	12.0	225



23 LEXA LT

SPINNING REEL

**AIRDRIVE
DESIGN**

**TOUGH
DIGIGEAR**

ATD | TYPE-L

The LT reel with metal body and Airdrive design.

By combining the new Airdrive Design concept with a distortion-proof metal reel body the 23' Lexa offers a silky-smooth running and large retrieving power.

The Airdrive concept further decreased the reel weight and shifts the balance to the back part – enabling an even more sensitive fishing and improved casting.

The Airdrive Rotor made of Zaion V material works even at low pressure without significant starting resistance and provides a high sensitivity and optimal lure presentation – even with lightweight lures. The metal reel body cares for a distortion-proof housing of the gear and permanent smooth running. The Tough Digigear is extremely strong and precise and ensures an optimal power transmission even under high load. The newly designed Airbail reliably offers protection from tanglings at the bail arm – perfect for fishing at strong wind. The extra-lightweight Airdrive spool leads to a decreased weight and due to the special spool rim allows long casting distances.

The Magsealed design at the shaft offers protection from intruding water and dirt particles and leads to a longer lifespan especially under the harsh conditions of sea fishing.

The perfect reel for ambitious fishing for zander, sea trout, pike and perch.



- AIRDRIVE Design
- Aluminum reel body
- 5 ball bearings
- ZAION V® AIRDRIVE ROTOR®
- TOUGH DIGIGEAR®

- ATD™ Type-L drag system
- AIRDRIVE ABS® longcast spool
- AIRDRIVE BAIL
- Twist Buster® III line roller
- Machined aluminum handle

Equipment:

Size 2500S is delivered with I-Shape handle knob. Sizes 2500, 3000S-C and 3000S-CXH feature a T-Shape handle knob. Sizes 3000, 3000-XH, 4000-C and 4000-CXH feature a round M-size EVA handle knob. Size 5000-C features a round L-size EVA handle knob.

Art.-No.	Size	BB total	Capacity m/mm	Ratio	Retrieval cm	Drag kg	Weight g
10228-250	2500	5	150/0.20	5.3:1	75	10.0	220
10228-251	2500S	5	150/0.16	5.3:1	75	5.0	215
10228-301	3000S-C	5	150/0.20	5.3:1	80	10.0	230
10228-302	3000S-CXH	5	150/0.20	6.2:1	93	10.0	230
10228-300	3000	5	150/0.23	5.2:1	77	10.0	245
10228-305	3000-XH	5	150/0.23	6.2:1	93	10.0	245
10228-400	4000-C	5	150/0.28	5.2:1	82	12.0	255
10228-405	4000-CXH	5	150/0.28	6.2:1	99	12.0	255
10228-500	5000-C	5	150/0.37	5.2:1	87	12.0	280



21 FREAMS LT

SPINNING REEL

LT LIGHT TOUGH

ZAION V

MAG SEALED

ATD
AUTOMATIC DRAG SYSTEM

The Freams LT combines exclusive Japanese technologies with an outstanding price-performance ratio.

The Freams LT convinces by technical details and optimal retrieving power. The reel body and the rotor are made of Zaion V and care for a distortion-proof housing of the gear within the reel body. The MagSealed construction prevents intrusion of dirt and water via the axis and ensures – in combination with the Zaion V material – a long lifespan of the gear and an enduringly smooth running. Due to the application of Zaion V carbon fiber material, the reel's weight could be further reduced. The ATD drag system cares for a minimal starting resistance of the drag and thus offers optimal security during critical fighting situations or when used with thin lines. The Tough Digigear provides optimal power transmission and high resilience. The special edge of the longcast aluminum spool reduces friction resistance during the cast and optimizes casting distances – ideally suited for light lures and rigs.

The Freams LT is suited for nearly all kind of fishing techniques in fresh water as well as fishing for sea trout and for light fishing for cod and pollack.



- **LT (Light & Tough)**
- **ZAION V® reel body**
- **MagSealed® body construction**
- **5 ball bearings**
- **ZAION V® AIR ROTOR®**
- **TOUGH DIGIGEAR®**
- **ATD™ drag system**
- **Forged ABS® aluminum longcast spool**
- **AIR BAIL®**
- **Twist Buster® II line roller**

Art.-No.	Size	BB total	Capacity m/mm	Ratio	Retrieval cm	Drag kg	Weight g
10229-101	1000D	5	150/0.20	5.2:1	64	5.0	185
10229-200	2000S	5	150/0.14	5.2:1	68	5.0	185
10229-201	2000D	5	150/0.20	5.3:1	68	5.0	185
10229-250	2500	5	150/0.20	5.3:1	75	10.0	200
10229-251	2500D	5	150/0.33	5.3:1	75	10.0	205
10229-252	2500-XH	5	150/0.20	6.2:1	87	10.0	200
10229-300	3000-C	5	150/0.23	5.3:1	80	10.0	210
10229-301	3000D-C	5	150/0.33	5.3:1	80	10.0	210
10229-400	4000-C	5	150/0.28	5.2:1	82	12.0	235
10229-500	5000-C	5	150/0.37	5.2:1	87	12.0	245



23 FUEGO LT

SPINNING REEL

AIRDRIVE
DESIGN

ZAION V

MAGSEALED

ATD | TYPE-L

With Airdrive Design – increased strength and sensitivity!

The 23' Fuego combines components from the new Airdrive Design with LT elements and the Magsealed structure.

The new Airdrive rotor leads to a weight reduction in the front unit of the reel and offers optimized balance for a decreased starting resistance. The low starting resistance leads to a better control at fishing, a higher sensitivity and an improved lure control.

The new Airdrive bail is more lightweight than before, ultimately tough and significantly decreases the threat of tanglings in combination with the new bail arm.

The powerful Tough Digigear works silky-smooth and is housed distortion-proof in the reel body made of Zaion V material. The Magsealed design reliably prevents the intrusion of saltwater and dirt particles over the shaft and leads to a long lifespan.

The Twistbuster III design at the line roller is perfect for the use of braided lines: the braid doesn't get compressed during retrieving and less twist is the result.

The new ATD Type-L drag cares for an even and optimized line release under strain without high starting resistance.

- AIRDRIVE Design
- ZAION V® reel body
- MagSealed® body construction
- 6 ball bearings
- ZAION V® AIRDRIVE ROTOR®
- TOUGH DIGIGEAR®
- Cross Wrap® system
- Cold forged ABS® aluminum longcast spool
- AIRDRIVE BAIL
- Twist Buster® III line roller



Equipment:

Sizes 1000D to 2500 are delivered with I-Shape handle knob. Sizes 3000-C, 3000-CXH, 3000D-C and 4000-CP feature a T-Shape handle knob. Sizes 4000D-CX, 5000-C and 6000D feature a L-size T-Shape handle knob.

Art.-No.	Size	BB total	Capacity m/mm	Ratio	Retrieval cm	Drag kg	Weight g
10333-100	1000D	6	150/0.20	5.2:1	64	5.0	175
10333-201	2000S-XH	6	150/0.14	6.2:1	81	5.0	180
10333-250	2500	6	150/0.20	5.3:1	75	10.0	195
10333-251	2500-XH	6	150/0.20	6.2:1	87	10.0	195
10333-300	3000-C	6	150/0.23	5.3:1	80	10.0	205
10333-301	3000-CXH	6	150/0.23	6.2:1	93	10.0	205
10333-305	3000D-C	6	150/0.33	5.3:1	80	10.0	205
10333-401	4000D-CXH	6	150/0.37	6.2:1	99	12.0	230
10333-404	4000-CP	6	150/0.28	4.7:1	75	12.0	230
10333-500	5000-C	6	150/0.37	5.2:1	87	12.0	240
10333-605	6000D	6	150/0.43	5.1:1	92	12.0	315



23 EXCELER LT

SPINNING REEL

AIRDRIVE
DESIGN

ZAION V

CROSS WRAP

ATD | TYPE-L

23' Exceler LT – The next Generation – with Airdrive design!

Thanks to the new lightweight Airdrive Rotor the starting resistance at reeling in is reduced. The total weight of the reel gets decreased and due to the weight reduction at the front unit the balance is shifted towards the back part of the reel. This leads to a better balance at the rod, improved sensitivity and a better casting performance. The reel body of Zaion V material cares for a distortion-proof housing of the Tough Digigear and permanent smooth running. The new Airdrive bail is more lightweight than before, ultimately tough and significantly decreases the threat of tanglings in combination with the new bail arm.

The ATD Type-L drag cares for an even and optimized line release under strain without high starting resistance, providing the required safety when fighting large specimen. The aluminum Longcast ABS spool features a special spool rim that contributes to longer casting distances. The Twistbuster III design at the line roller is perfect for the use of braided lines: the braid doesn't get compressed during retrieving and less twist is the result. The CNC cut aluminum handle is firmly screwed into the body for instant contact.

- AIRDRIVE Design
- ZAION V® reel body
- 5 ball bearings
- ZAION V® AIRDRIVE ROTOR®
- TOUGH DIGIGEAR®
- ATD™ Type-L drag system

- Cross Wrap® system
- Forged ABS® aluminum longcast spool
- AIRDRIVE BAIL
- Twist Buster® III line roller

Equipment:

Sizes 1000 to 2000 are delivered with I-Shape handle knob, sizes 2500 to 5000 with T-Shape handle knob.



Art.-No.	Size	BB total	Capacity m/mm	Ratio	Retrieval cm	Drag kg	Weight g
10336-100	1000D	5	150/0.20	5.2:1	64	5.0	175
10336-200	2000D	5	150/0.23	5.2:1	68	5.0	180
10336-250	2500	5	150/0.20	5.3:1	75	10.0	195
10336-251	2500-XH	5	150/0.20	6.2:1	87	10.0	195
10336-300	3000-C	5	150/0.23	5.3:1	80	10.0	200
10336-301	3000-CXH	5	150/0.23	6.2:1	93	10.0	200
10336-400	4000-C	5	150/0.28	5.2:1	82	12.0	225
10336-401	4000D-C	5	150/0.37	5.2:1	82	12.0	225
10336-500	5000-C	5	150/0.37	5.2:1	87	12.0	235



23 LEGALIS LT

SPINNING REEL

AIRDRIVE
DESIGN

ZAION V

CROSS WRAP

ATD | TYPE-L

Airdrive Design from Japan – at an unbeatable price-performance ratio.

The 23' Legalis is lighter and tougher than the previous model and features the new Airdrive Design concept. Size 2500 weighs only 195 grams!

The Airdrive rotor made of Zaion V material starts with low starting resistance, leading to a better lure control and more sensitivity. By shifting the center of gravity to the back part of the reel an improved total balance at casting is achieved. The Tough Digigear offers high retrieving power and is securely housed in the reel body made of Zaion V material, resulting in high durability and smooth functioning – perfect for spin fishing for zander, perch, pike and trout.

The new Airdrive bail is more lightweight than before, ultimately tough and significantly decreases the threat of tanglings in combination with the new bail arm. The ATD Type-L drag cares for an even and optimized line release under strain without high starting resistance, providing the required safety when fighting large specimen. The aluminum Longcast ABS spool features a special spool rim that contributes to longer casting distances. The Twistbuster III design at the line roller is perfect for the use of braided lines: the braid doesn't get compressed during retrieving and less twist is the result.

- AIRDRIVE Design
- ZAION V® reel body
- 5 ball bearings
- ZAION V® AIRDRIVE ROTOR®
- TOUGH DIGIGEAR®
- ATD™ Type-L drag system
- Cross Wrap® system
- Forged ABS® aluminum longcast spool
- AIRDRIVE BAIL
- Twist Buster® III line roller
- Machined screw-in aluminum handle



Equipment:

Sizes 1000 to 2000 are delivered with I-Shape handle knob, sizes 2500 to 5000 with T-Shape handle knob.

Art.-No.	Size	BB total	Capacity m/mm	Ratio	Retrieval cm	Drag kg	Weight g
10435-100	1000D	5	150/0.20	5.2:1	64	5.0	175
10435-200	2000D	5	150/0.23	5.2:1	68	5.0	180
10435-205	2000S-XH	5	150/0.14	6.2:1	81	5.0	180
10435-250	2500D	5	150/0.28	5.3:1	75	10.0	200
10435-251	2500	5	150/0.20	5.3:1	75	10.0	200
10435-300	3000-C	5	150/0.23	5.3:1	80	10.0	205
10435-305	3000-CXH	5	150/0.23	6.2:1	93	10.0	205
10435-400	4000-C	5	150/0.28	5.2:1	82	12.0	230
10435-500	5000-C	5	150/0.37	5.2:1	87	12.0	240



24 REGAL LT

NEW

SPINNING REEL

AIRDRIVE
DESIGN

ZAION V

CROSS WRAP

ATD | TYPE-L

DAIWA's Airdrive Technology for an incredible reasonable price.

The 24 Regal LT reels are even lighter than the previous series and offer outstanding lure feeling and sensitivity. The Airdrive Bail eliminates the risk of line tangles on the bail arm during cast. The Tough Digigear supports perfect power transmission under load and offers an outstanding smooth rotation. The ATD Type-L drag releases line without inertia and is perfectly suited for thin monofilament and braided lines. The high-quality major paint slightly changes color depending on the light angle and creates an outstanding pretty look.

- AIRDRIVE Design
- ZAION V® reel body
- ZAION V® body cover
- 6 ball bearings
- AIRDRIVE ROTOR
- TOUGH DIGIGEAR®
- Infinite Anti-Reverse®
- ATD™ Type-L drag system
- Cross Wrap® system
- ABS® aluminum longcast spool
- Twist Buster® III line roller
- Aluminum handle
- T-Shape handle knob



Art.-No.	Size	BB total	Capacity m/mm	Ratio	Retrieval cm	Drag kg	Weight g
10116-107	1000D-XH	6	150/0.20	6.2:1	77	5.0	180
10116-207	2000D-XH	6	150/0.23	6.2:1	81	5.0	185
10116-257	2500D-XH	6	150/0.28	6.2:1	87	10.0	200
10116-307	3000D-CXH	6	150/0.33	6.2:1	93	10.0	205
10116-407	4000D-CXH	6	150/0.37	6.2:1	99	12.0	240
10116-507	5000D-C	6	150/0.40	5.2:1	87	12.0	240



GS LTD

SPINNING REEL



DIGIGEAR

AIR ROTOR



Classic-style all-round model for various purposes.

The GS LTD reels from DAIWA resemble an icon thanks to the combination of a golden spool with a black body. The newest technology made by DAIWA has been included within this reel.

The Digigear in combination with the Air Rotor ensure a silky-smooth running.

This classic-style reel with wooden handle knob is a real all-rounder for feeder fishing or stalking, for fishing for barbels as well as for spin fishing.

- 4 ball bearings
- AIR ROTOR®
- DIGIGEAR®
- Infinite Anti-Reverse®
- ATD™ drag system
- Cross Wrap® system
- Aluminum spool
- Distance Control line clip
- Twist Buster® II line roller
- One-touch fast snap handle
- Wooden handle knob



Art.-No.	Size	BB total	Capacity m/mm	Ratio	Retrieval cm	Drag kg	Weight g
10501-305	3000	4	220/0.28	4.7:1	79	10.0	305
10501-405	4000	4	270/0.30	4.9:1	87	12.0	400



23 NINJA LT

SPINNING REEL

**AIRDRIVE
DESIGN**

ATD | TYPE-L

With the 23' Ninja DAIWA offers the latest Japanese design concept and inspirational technics – at an outstanding price-performance ratio!

Compared to the previous model the 23' Ninja has been improved regarding essential features and now is more sensitive and stronger.

Thanks to the application of the new lightweight Airdrive Rotor the reel balance is shifted from the front unit to the lower reel part, leading to an improved total balance and a higher sensitivity at fishing. The lure feeling is improved and faster reactions are possible. The precise and tough Digigear cares for high retrieving power and permanent silky-smooth and even running.

The new Airdrive bail is lighter than the previous version, highly durable and in combination with the new bail arm considerably decreases tanglings at casting. If the line should get tangled at the bail arm, it simply slides to the line roller via the arm when the handle is turned – to action necessary. The ATD Type-L drag cares for an even and optimized line release under strain without high starting resistance, providing the required safety when fighting large specimen. The aluminum Longcast ABS spool features a special spool rim that contributes to longer casting distances. The Twistbuster III design at the line roller is perfect for the use of braided lines: the braid doesn't get compressed during retrieving and less twist is the result.

- AIRDRIVE Design
- 4 ball bearings
- AIRDRIVE ROTOR®
- TOUGH DIGIGEAR®
- ATD™ Type-L drag system
- Forged ABS® longcast spool
- AIRDRIVE BAIL
- Twist Buster® III line roller
- Machined aluminum handle



Equipment:

Sizes 1000 to 2000 are delivered with I-Shape handle knob, sizes 2500 to 6000 with T-Shape handle knob.

Art.-No.	Size	BB total	Capacity m/mm	Ratio	Retrieval cm	Drag kg	Weight g
10005-100	1000	4	150/0.14	5.2:1	64	5.0	205
10005-200	2000	4	150/0.16	5.2:1	68	5.0	210
10005-250	2500	4	150/0.20	5.3:1	75	10.0	230
10005-251	2500-XH	4	150/0.20	6.2:1	87	10.0	230
10005-300	3000-C	4	150/0.23	5.7:1	80	10.0	240
10005-351	3000-CXH	4	150/0.23	6.2:1	93	10.0	240
10005-400	4000-C	4	150/0.28	5.2:1	82	12.0	270
10005-500	5000-C	4	150/0.37	5.2:1	87	12.0	270
10005-600	6000	4	150/0.40	5.1:1	92	12.0	365



23 NINJA LT

NEW 🚗

SPINNING REEL | PRE-SPOOLED

**AIRDRIVE
DESIGN**

ATD | TYPE-L

The 23 Ninja reels with the new Airdrive Design are now also available pre-spooled with original DAIWA J-Braid X4 in yellow.

- AIRDRIVE Design
- 4 ball bearings
- AIRDRIVE ROTOR®
- TOUGH DIGIGEAR®
- Infinite Anti-Reverse®
- ATD™ Type-L drag system
- Forged ABS® longcast spool
- AIRDRIVE BAIL
- Twist Buster® III line roller
- Machined aluminum handle

Handle knob

Size 2000 is delivered with I-Shape handle knob, sizes 2500 to 4000 with T-Shape handle knob.

Equipment:

Size 2000 is pre-spooled with a J-Braid X4, model 0.13mm/130m.

Size 2500 is pre-spooled with a J-Braid X4, model 0.19mm/95m.

Size 3000-C is pre-spooled with a J-Braid X4, model 0.19mm/130m.

Size 4000-C is pre-spooled with a J-Braid X4, model 0.21mm/160m.

All sizes are pre-spooled with yellow color.



Art.-No.	Size	BB total	Capacity m/mm	Ratio	Retrieval cm	Drag kg	Weight g
10006-200	2000	4	150/0.16	5.2:1	68	5.0	210
10006-250	2500	4	150/0.20	5.3:1	75	10.0	230
10006-300	3000-C	4	150/0.23	5.3:1	80	10.0	240
10006-400	4000-C	4	150/0.28	5.2:1	82	10.0	270



23 REVROS LT

SPINNING REEL

**AIRDRIVE
DESIGN**

ATD | TYPE-L

With Airdrive Rotor and Airdrive Bail!

Thanks to the application of the new lightweight Airdrive Rotor the reel balance is shifted from the front unit to the lower reel part, leading to an improved total balance and a higher sensitivity at fishing. The lure feeling is improved and faster reactions are possible. The precise and tough Digigear cares for high retrieving power and permanent silky-smooth and even running.

The new Airdrive bail is lighter than the previous version, highly durable and in combination with the new bail arm considerably decreases tanglings at casting. If the line should get tangled at the bail arm, it simply slides to the line roller via the arm when the handle is turned – to action necessary.

The ATD Type-L drag cares for an even and optimized line release under strain without high starting resistance, providing the required safety when fighting large specimen. The aluminum Longcast ABS spool features a special spool rim that contributes to longer casting distances. The Twistbuster III design at the line roller is perfect for the use of braided lines: it doesn't get compressed during retrieving and less twist is the result.

- **AIRDRIVE Design**
- **DS4 reel body**
- **4 ball bearings**
- **DS4 AIRDRIVE ROTOR**
- **TOUGH DIGIGEAR®**
- **ATD™ Type-L drag system**
- **Cross Wrap® system**
- **Cold forged ABS® aluminum longcast spool**
- **AIRDRIVE BAIL**
- **Twist Buster® III line roller**
- **Machined screw-in aluminum handle**



Equipment:

Sizes 1000 to 2500 are delivered with I-Shape handle knob, sizes 3000 to 5000 with T-Shape handle knob.

Art.-No.	Size	BB total	Capacity m/mm	Ratio	Retrieval cm	Drag kg	Weight g
10221-102	1000	4	150/0.14	5.2:1	64	5.0	205
10221-202	2000	4	150/0.16	5.2:1	68	5.0	210
10221-252	2500	4	150/0.20	5.3:1	75	10.0	230
10221-302	3000-C	4	150/0.23	5.3:1	80	10.0	240
10221-303	3000-CXH	4	150/0.23	6.2:1	93	10.0	240
10221-402	4000-C	4	150/0.28	5.2:1	82	10.0	270
10221-403	4000-CXH	4	150/0.28	6.2:1	99	12.0	270
10221-502	5000-C	4	150/0.37	5.2:1	87	12.0	270



20 LAGUNA LT

SPINNING REEL | PRE-SPOOLED



The LT reel incl. J-Braid X4.

The Laguna likewise features the LT design and offers premium DAIWA technology at an outstanding price-performance ratio. Pre-spooled with J-Braid X4.

- LT (Light & Tough)
- DS4 reel body
- 3 ball bearings
- DS4 ROTOR
- Infinite Anti-Reverse®
- ATD™ drag system
- Cross Wrap® system
- ABS® aluminum longcast spool
- Twist Buster® II line roller

Equipment:

Size 2000 is pre-spooled with a J-Braid X4, model 0.13mm/130m.
 Size 2500 is pre-spooled with a J-Braid X4, model 0.19mm/95m.
 Size 3000-C is pre-spooled with a J-Braid X4, model 0.19mm/130m.
 Size 4000-C is pre-spooled with a J-Braid X4, model 0.21mm/160m.
 All sizes are pre-spooled with yellow color.



Handle knob

Sizes 2000 to 3000 are delivered with I-Shape handle knob, size 4000 with T-Shape handle knob.

Art.-No.	Size	BB total	Capacity m/mm	Ratio	Retrieval cm	Drag kg	Weight g
10502-200	2000	3	150/0.16	5.2:1	68	5.0	225
10502-250	2500	3	150/0.20	5.3:1	75	10.0	255
10502-300	3000-C	3	150/0.23	5.3:1	80	10.0	260
10502-400	4000-C	3	150/0.28	5.2:1	82	12.0	295



QR 750 / QC 750

Lightweights!

With the two versions of the QR / QC models DAIWA offers two extra-small spinning reels for ultra-light fishing. Perfect for targeting coregones, light perch fishing or for light rods at the pond. With foldable handle and ABS longcast spool.

QR 750

SPINNING REEL

- 3 ball bearings
- Infinite Anti-Reverse®
- ABS® aluminum spool
- Aluminum fast snap handle
- I-Shape handle knob

QC 750

SPINNING REEL

- 1 ball bearing
- Infinite Anti-Reverse®
- ABS® aluminum spool
- Aluminum fast snap handle
- I-Shape handle knob



QR 750

Art.-No.	Size	BB total	Capacity m/mm	Ratio	Retrieval cm	Drag kg	Weight g
10431-075	750	3	100/0.16	5.1:1	58	3.0	175

QC 750

Art.-No.	Size	BB total	Capacity m/mm	Ratio	Retrieval cm	Drag kg	Weight g
10431-175	750	1	100/0.16	5.1:1	58	3.0	175



20 CROSSFIRE LT

SPINNING REEL

LT LIGHT TOUGH

CROSS WRAP

TOUGH DIGIGEAR

ATD
AUTOMATIC DRAG SYSTEM

Modern design at an outstanding price-performance ratio.

The Crossfire LT convinces by a silky-smooth running and great power reserves. The LT design allows the development of smaller reel bodies with conventionally sized spools, which can be applied without much effort due to the low weight. The longcast ABS aluminum spool displays a decreased friction resistance during the cast and therefore enables longer casts.

- LT (Light & Tough)
- 3 ball bearings
- TOUGH DIGIGEAR®
- Infinite Anti-Reverse®
- ATD™ drag system
- Cross Wrap® system
- Silent Oscillation® system
- ABS® aluminum longcast spool
- Twist Buster® II line roller
- CNC-machined aluminum handle



Art.-No.	Size	BB total	Capacity m/mm	Ratio	Retrieval cm	Drag kg	Weight g
10186-200	2000	3	150/0.16	5.2:1	68	5.0	225
10186-250	2500	3	150/0.20	5.3:1	75	10.0	255
10186-300	3000-C	3	150/0.23	5.3:1	80	10.0	260
10186-400	4000-C	3	150/0.28	5.2:1	82	12.0	290



SWEEPFIRES EC

SPINNING REEL

DIGIGEAR

ABS II
ANTI-BACKLASH SYSTEM

TWISTBUSTER
II

Perfect for occasional anglers and universally applicable

At the Sweepfire, DAIWA's engineers especially focused on extreme soft and smooth running as you are used to it from considerably more expensive reels. The line lay is exemplary and also suitable for the use of extremely thin braided and monofilament lines. The Sweepfire EC combines Japanese know-how with an outstanding price-performance ratio.

Depending on the size, perfectly suited for pike, zander, carp, trout and – in large sizes – also for cod and coalfish.

- 1 ball bearing
- DIGIGEAR® II
- Multi-Stop anti-reverse
- ABS® II aluminum spool
- Twist Buster® II line roller
- Longlife bail spring



Art.-No.	Size	BB total	Capacity m/mm	Ratio	Retrieval cm	Drag kg	Weight g
10118-150	1500	1	140/0.20	5.3:1	68	2.0	230
10118-200	2000	1	125/0.25	5.3:1	74	2.0	230
10118-250	2500	1	190/0.25	5.3:1	80	4.0	260
10118-300	3000	1	220/0.28	5.3:1	82	4.0	260
10118-350	3500	1	220/0.30	5.3:1	92	4.0	370
10118-400	4000	1	270/0.30	5.3:1	95	6.0	380
10118-500	5000	1	370/0.35	4.6:1	99	6.0	630



21 PRESSO LT

NEW

SPINNING REEL

LT LIGHT TOUGH

ZAION

MQ

ATD
AUTOMATIC DRAG SYSTEM

The lightest Presso Reel ever made – a trout angler's dream!

Perfect for commercial trout ponds, streams and rivers.

Ultimate refinement is the key and the use of oiled ball bearings on the main gear provides a new dimension of sensitivity. In alliance with its powerful low gear ratio, a unbelievable feeling is provided that let's you realized even tiny bites. The super shallow spool is designed to be loaded with very thin lines and is perfectly suitable for ultra-light Finesse fishing with small lures. The ATD drag with special drag grease smoothly releases line and reduces the risk of breakage and lost fish. The torsion resistant MQ Zaion body is extremely light weight and securely holds the gearing to offer constant smooth rotation.

- LT (Light & Tough)
- ZAION® MQ® Monocoque reel body
- 12 ball bearings (incl. 5 CRBB®)
- ZAION® ROTOR
- CNC-machined TOUGH DIGIGEAR®
- ATD™ drag system
- Cross Wrap® system
- Aluminum longcast spool
- AIR BAIL®
- Twist Buster® II line roller
- Aluminum handle



Art.-No.	Size	BB CRBB	BB total	Capacity m/mm	Ratio	Retrieval cm	Drag kg	Weight g
00060380	1000 S-P	5	12	100/0.12	4.9:1	61	5.0	145
00060381	2000 SS-P	5	12	100/0.12	4.9:1	64	5.0	150



Silver Creek

22 SILVER CREEK MQ LT

NEW

SPINNING REEL

LT LIGHT TOUGH

ZAION V

MQ

ATD
AUTOMATIC DRAG SYSTEM

Thanks to the high gear ratio, the Silver Creek MQ LT is especially designed to be fished in rivers and streams once you need to retrieve line quick acting to achieve a perfect lure action.

The super shallow spool is specially designed for usage with very thin lines. The ATD drag smoothly releases line without inertia and reduces the risk of breakage and lost fish. The light weight MQ body secures perfect hold of the inner gearing and long-lasting smooth rotation.

- **LT (Light & Tough)**
- **ZAION V® MQ® Monocoque reel body**
- **Aluminum body cover**
- **6 ball bearings (incl. 1 CRBB®)**
- **ZAION V® AIR ROTOR®**
- **ATD™ drag system**
- **Aluminum longcast spool**
- **AIR BAIL®**
- **Machined screw-in aluminum handle**
- **Cork handle knob**



Art.-No.	Size	BB CRBB	BB total	Capacity m/mm	Ratio	Retrieval cm	Drag kg	Weight g
10307-200	2000 S-H	1	6	150/0.14	5.8:1	76	5.0	175
10307-201	2500 S-XH	1	6	150/0.16	6.2:1	87	5.0	195



24 IPRIMI LT

NEW

SPINNING REEL

AIRDRIVE
DESIGN

ATD | TYPE-L

The UL Trout Reel with power gearing.

The Iprimi LT was specially designed for Finesse techniques on trout ponds with smallest lures. Thanks to the low gear ratio, feeling and sensitivity are improved and every tiny bite can be detected. The Airdrive Design nearly eliminates the risk of line tangles around the bail arm during cast and improves sensitivity by shifting the centre of gravity to the reel's rear part. The lightweight Airdrive rotor made by Zaion V material spins with reduced inertia and additionally supports sensitivity. The I-shape handle knob made by Zaion material instantly transfers lure action into your fingers. The ATD Type-L drag releases line without delay and is perfectly suited to be used with thin lines.

- AIRDRIVE Design
- ZAION V® reel body
- ZAION V® body cover
- 6 ball bearings (incl. 1 CRBB®)
- ZAION V® AIRDRIVE ROTOR®
- TOUGH DIGIGEAR®
- ATD™ Type-L drag system
- Cross Wrap® system
- ABS® aluminum longcast spool
- AIRDRIVE BAIL
- Twist Buster® III line roller
- Aluminum handle
- ZAION® handle knob



Art.-No.	Size	BB CRBB	BB total	Capacity m/mm	Ratio	Retrieval cm	Drag kg	Weight g
10180-100	1000 S-P	1	6	100/0.12	4.8:1	60	5.0	170
10180-200	2000 S-P	1	6	150/0.14	4.8:1	63	5.0	175



22 SILVER CREEK X LT

NEW

SPINNING REEL

LT LIGHT TOUGH

ZAION V

CROSS WRAP

ATD
AUTOMATIC DRAG SYSTEM

The Silver Creek X LT offers perfect lure control for light predator fishing!

Thanks to the LT Concept and the rotor made by Zaion V material, our engineers were able to develop an extremely lightweight and torque resistant reel. The Tough Digigear is firmly bedded in the body and provides outstanding smooth rotation. The ABS spool is featuring a special lip that reduces line friction during cast and improves casting distances. The ATD drag releases line without inertia and is perfectly suited to be used with thin lines.



- LT (Light & Tough)
- ZAION V® reel body
- ZAION V® body cover
- 5 ball bearings
- ZAION V® AIR ROTOR®
- TOUGH DIGIGEAR®
- ATD™ drag system
- Cross Wrap® system
- AIR BAIL®
- Machined screw-in aluminum handle
- Cork handle knob



Art.-No.	Size	BB total	Capacity m/mm	Ratio	Retrieval cm	Drag kg	Weight g
10308-200	2000 S-XH	5	150/0.14	6.2:1	81	5.0	185
10308-201	2500 S-XH	5	150/0.16	6.2:1	87	5.0	200



MATCH- & FEEDER REELS





20 TOURNAMENT QD

MATCH & FEEDER REEL

QD

HardBodyz™
Light & Rigid Metal Construction

ZAION
AIR ROTOR

MAGSEALED

Ultra-strong for highest demands.

With the Tournament QD reels DAIWA presents a series of match and feeder reels for uncompromising application, which you entirely can rely on during the tough challenges at fishing in competition mode.

The HardBodyZ reel body is the foundation of a permanent solid housing of the gear even at excessive and demanding application. The Tough Digigear is in charge for a smooth running and is highly resistant.

By further optimizing the design as well as the Zaion rotor the weight has been considerably lowered compared with the previous edition TD-X – thus the 3010QD weights only 290 grams!

By the MagSealed design the intrusion of water and dirt particles is prevented, which markedly prolongs the lifespan of the reel. With the help of the QD drag system you can react to changing conditions during the fight with the fish within seconds.

The longcast ABS aluminum spool features less friction during the cast and enhances your casting distances.

The Tournament QD in size 3010 is also available with One-Touch double handle. (art.-no. 10406-310)

- **HARDBODYZ®** aluminum reel body
- **MagSealed®** body construction
- **10 ball bearings** (incl. 2 CRBB®)
- **ZAION® AIR ROTOR®**
- **DIGIGEAR® II**
- **Infinite Anti-Reverse®**
- **QD® Quick drag system**
- **Cross Wrap® system**
- **Silent Oscillation® system**
- **ABS® aluminum longcast spool**
- **2 aluminum spare spools**
- **HIP® line clip**
- **AIR BAIL®**
- **MagSealed® Twist Buster® II line roller**



10406-310

Art.-No.	Size	BB CRBB	BB total	Capacity m/mm	Ratio	Retrieval cm	Drag kg	Weight g
10406-305	3010	2	10	150/0.26	4.7:1	79	12.0	290
10406-310	3010 DH	2	11	150/0.26	4.7:1	79	12.0	300
10406-405	4010	2	10	150/0.26	4.9:1	86	12.0	405



24 TDR MATCH & FEEDER QD

MATCH & FEEDER REEL

AIRDRIVE DESIGN TOUGH DIGIGEAR *QD*

The latest TDR Match & Feeder reel with Airdrive Design!

Thanks to the Airdrive Design the new TDR is more lightweight and sensitive compared to the previous version. The Airdrive rotor cares for an enhanced sensitivity during the fight and reduces the threat of unhooking. The one-piece hollow Airdrive bail together with the extra-lightweight Airdrive spool and the new rotor lead to a decreased reel weight at the front and an improved balance – a better casting performance is the consequence.

The aluminum HardbodyZ reel body cares for a distortion-proof housing of the Tough Digigear and great retrieving power. The large gear wheels at the drive unit additionally lead to a calm functioning and optimal power transmission – perfect, when heavy rigs have to be retrieved over long distances. The aluminum Longcast ABS spool features a special spool rim that reduces friction and contributes to longer casting distances.

The Twistbuster III design at the line roller is perfect for the use also of braided lines: the braid doesn't get compressed during retrieving and less twist is the result. With novel screwed-in aluminum quick-fold handle!

The 24' TDR in size 3012 is also available with One-Touch double handle. (art.-no. 10516-313)

- AIRDRIVE Design
- Machine-milled metal housing
- 8 ball bearings (incl. 1 CRBB®)
- AIRDRIVE ROTOR®
- TOUGH DIGIGEAR®
- QD® Quick drag system
- ABS® aluminum longcast spool
- HIP® line clip
- AIRDRIVE BAIL
- Twist Buster® III line roller
- One-touch fast snap handle
- Round EVA handle knob



10516-313

Art.-No.	Size	BB CRBB	BB total	Capacity m/mm	Ratio	Retrieval cm	Drag kg	Weight g
10516-258	2508QD	1	8	0.23/150	4.8:1	72	10.0	250
10516-312	3012QD	1	8	0.28/150	4.8:1	79	12.0	285
10516-313	3012QD-DH	1	9	0.28/150	4.8:1	79	12.0	300
10516-412	4012QD	1	8	0.28/150	4.9:1	86	12.0	380

NEW



18 TD FEEDER QD

FEEDER REEL

QD

HardBodyz
Light & Rigid Metal
Construction

AIR ROTOR

DIGIGEAR

Tough, powerful and prepared for every situation.

With the TD Feeder DAIWA offers a reel with aluminum body for harsh conditions. The Digigear II cares for optimum retrieving power – perfect, when heavy feeder rigs have to be winded in over long distances. The HardBodyZ aluminum body cares for a secure housing of the gear and thus increases the lifespan. Also thin or braided lines can be securely fixed by the spring-mounted HIP line clip. Thanks to the foldable reel handle, the mounted rod can be conveniently transported in a rod bag.

- **HARDBODYZ**® aluminum reel body
- **6** ball bearings
- **AIR ROTOR**®
- **DIGIGEAR**®
- **Infinite Anti-Reverse**®
- **QD**® Quick drag system
- **Cross Wrap**® system
- **Silent Oscillation**® system
- **HIP**® line clip
- **AIR BAIL**®
- **Twist Buster**® II line roller
- **One-touch fast snap handle**



Art.-No.	Size	BB total	Capacity m/mm	Ratio	Retrieval cm	Drag kg	Weight g
10419-412	4012	6	150/0.29	4.9:1	87	8.0	440



19 TDM QD

MATCH & FEEDER REEL

QD

HardBodyz
Light & Rigid Metal Construction

AIR ROTOR DIGIGEAR

Specialist reel with ultra-fast reaction time.

Compared to the previous edition the TDM Team DAIWA Match has been improved regarding some important features and convinces by highest quality and functionality. The aluminum reel body cares for optimal housing of the gear and permanent smooth running.

The supersized anti reverse lever is easy to grasp at critical situations during the fight with the fish, allowing convenient switching to backwinding.

The longcast ABS aluminum spool offers less friction resistance at the cast and increases the casting distance. The spring-loaded distance control line clip offers optimal safety to act precisely in the targeted area.

The large EVA handle knob offers optimal grip and perfect transmission at retrieving.

The QD drag system allows instant adoption to critical situations during the fight with the fish. Also the drag power of the TDM QD has been increased considerably to 12kg at both sizes.

- **HARDBODYZ**® aluminum reel body
- 4 ball bearings
- **AIR ROTOR**®
- **DIGIGEAR**® II
- Infinite Anti-Reverse®
- **QD**® Quick drag system
- **Cross Wrap**® system
- **Silent Oscillation**® system

- **ABS**® aluminum longcast spool
- **Aluminum spare spool**
- **Distance Control** line clip
- **AIR BAIL**®
- **Twist Buster**® II line roller
- **One-touch fast snap handle**
- **EVA handle knob**



Art.-No.	Size	BB total	Capacity m/mm	Ratio	Retrieval cm	Drag kg	Weight g
10420-312	3012	4	150/0.28	4.7:1	79	12.0	305
10420-412	4012	4	150/0.28	4.9:1	86	12.0	400



23 NINJA MATCH & FEEDER LT

MATCH & FEEDER REEL

AIRDRIVE
DESIGN

TOUGH
DIGIGEAR

CROSS WRAP

ATD | TYPE-L

The 23' Ninja Match & Feeder models with Airdrive Design – silky-smooth functioning and perfect power transmission.

The Airdrive Rotor decreases the weight at the front part of the reel, leading to an improved balance and higher sensitivity. The strong Digigear offers huge retrieving power and cares for a permanent smooth functioning.

The new Airdrive bail is lighter than the previous version, highly durable and in combination with the new bail arm considerably decreases tanglings at casting. If the line should get tangled at the bail arm, it simply slides to the line roller via the arm when the handle is turned – to action necessary. The ATD Type-L drag cares for an even and optimized line release under strain without high starting resistance, providing the required safety when fighting large specimen. The aluminum Longcast ABS spool features a special spool rim that lowers friction and contributes to longer casting distances. The Twistbuster III design at the line roller is perfect for the use of braided lines: the braid doesn't get compressed during retrieving and less twist is the result.

- AIRDRIVE Design
- 4 ball bearings
- AIRDRIVE ROTOR®
- TOUGH DIGIGEAR®
- ATD™ Type-L drag system
- Cross Wrap® system
- Forged ABS® aluminum longcast spool
- AIRDRIVE BAIL
- Twist Buster® III line roller
- Machined aluminum handle
- T-Shape handle knob



Equipment:
Size 6000 features a L-size T-Shape handle knob.

Art.-No.	Size	BB total	Capacity m/mm	Ratio	Retrieval cm	Drag kg	Weight g
10217-305	3000-C	4	150/0.23	5.3:1	80	10.0	260
10217-405	4000-C	4	150/0.28	5.2:1	82	12.0	285
10217-605	6000SS	4	150/0.28	5.1:1	92	12.0	390



23 MATCHMAN

SPINNING REEL

CROSS WRAP

UTD Drag
ULTIMATE TOURNAMENT DRAG

The starter model from the DAIWA Match & Feeder reels – inspirational technics.

With quick-fold handle and aluminum spool.

- 3 ball bearings
- DIGIGEAR® II
- Infinite Anti-Reverse®
- UTD® drag system
- Cross Wrap® system
- ABS® aluminum spool
- Twist Buster® II line roller
- Fast snap handle



Art.-No.	Size	BB total	Capacity m/mm	Ratio	Retrieval cm	Drag kg	Weight g
10113-250	2500	3	150/0.28	5.3:1	80	4.0	300
10113-300	3000	3	200/0.28	5.3:1	82	4.0	295
10113-400	4000	3	250/0.33	5.3:1	95	6.0	435



21 TOURNAMENT FEEDER 25 QD

LONGCAST FEEDER REEL | WITH 25MM SPOOL STROKE

QD **TOUGH DIGIGEAR** **MAG SEALED** **ZAION**

Longcast tool with power gear.

DAIWA Big Pit reels with 25mm spool stroke are especially established at feeder fishing. The Tournament Feeder is based on the same frame as e.g. the TDR Distance Feeder 25 QD, but has been updated according modern fishing specifications.

The distortion-proof Zaion reel body in combination with an aluminum body-cover ensures for an optimal housing of the gear and enduringly smooth running. The Tough Digigear II offers enormous retrieving power and cares for optimal smooth running even when used repeatedly with heavy feeders. The One-Touch quick fold handle enables a complication-free transportation of the rigged rod within the holdall. Two HIP line clips at the spool make it possible to precisely target two different fishing spots.

The aluminum longcast ABS spool reduces friction resistance during the cast and guarantees improved casting distances.



- ZAION® reel body
- Aluminum body cover
- MagSealed® body construction
- 7 ball bearings
- AIR ROTOR®
- TOUGH DIGIGEAR® II
- Infinite Anti-Reverse®
- QD® Quick drag system
- 25mm spool stroke
- Aluminum longcast spool
- Aluminum spare spool
- HIP® line clip (double)
- AIR BAIL®
- Twist Buster® II line roller
- One-touch fast snap handle
- Manual bail return

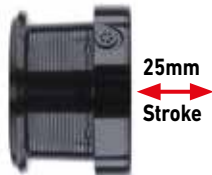

25mm
Stroke

Art.-No.	BB total	Capacity m/mm	Ratio	Retrieval cm	Drag kg	Weight g
10924-025	7	150/0.28	4.7:1	96	12.0	455





23 TDR DISTANCE 25 QD

LONGCAST FEEDER REEL | WITH 25MM SPOOL STROKE

QD DIGIGEAR

The power reel for feder fishing – with 25mm spool stroke and QD drag.

The TDR Distance offers highest retrieving power thanks to the Digigear II – perfect for heavy rigs at long distances.

The strong Zaion V rotor in combination with the distortion-proof Zaion reel body and the aluminum Body Cap lead to an optimal power transmission and a safe housing of the gear. The aluminum longcast handle features an optimized spool rim, reducing friction and improving the casting distances. With One-Touch quick-fold handle and extra-shallow spare spool for braided lines (0.12mm/135m).

- ZAION® reel body
- 6 ball bearings
- ZAION V® ROTOR
- DIGIGEAR® II
- QD® Quick drag system
- 25mm spool stroke
- Longcast spool
- HIP® line clip
- AIR BAIL®
- One-touch fast snap handle
- T-Shape handle knob, L-size
- Manual bail return

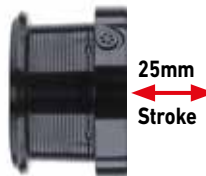

Art.-No.	Size	BB total	Capacity m/mm	Ratio	Retrieval cm	Drag kg	Weight g
10922-026	25	6	150/0.28	4.7:1	96	12.0	450



FREE SPOOL REELS



EMBLEM BR

FREESPOOL REEL



AIR ROTOR

TOUGH DIGIGEAR

CROSS WRAP

Power freespool by DAIWA.

The Emblem BR 10000 offers enormous power reserves and optimal handling. The big Tough Digigear driving wheel is positioned distortion-proove within the reel body and offers enough power during tough fights to controll even biggest fish effortless. The ATD drag system with carbon fiber brake discs ensure an immediet starting of the set drag power without starting resistance and thus reduces the danger of losses during the fight. The ABS longcast spool reduces the friction resistance during the cast and enables optimal casting distances. The Cross Wrap line lay guarantees longest casts even when used with braided lines. With the size 10000 and a line capacity of about 330m/Ø0.35mm, the 22' Emblem BR is perfectly made for medium distances. The HIP line clip protects the line while targeting the same spot several times. The finely adjustable free spool reel can be adapted easily and quickly to nearly all fishing situations at the lake and the river.

The Emblem BR reel is now available in an additional 14000 size with extra large line capacity. Perfect for long distance fishing.



- 5 ball bearings
- AIR ROTOR®
- TOUGH DIGIGEAR®
- Infinite Anti-Reverse®
- ATD™ drag system
- Bite'N'Run® free spool
- Cross Wrap® system
- CNC-machined aluminum longcast spool
- HIP® line clip
- Twist Buster® II line roller
- Machined aluminum handle
- T-Shape handle knob
- Manual bail return

Art.-No.	Size	BB total	Capacity m/mm	Ratio	Retrieval cm	Drag kg	Weight g
10158-100	10000	5	300/0.37	4.7:1	100	10.0	640
10158-140	14000	5	400/0.37	4.7:1	102	10.0	615

NEW



24 EMCAST BR LT

NEW

COMPACT BITE'N RUN REEL

AIRDRIVE DESIGN **TOUGH DIGIGEAR**

Small and compact LT free spool reels featuring DAIWA's exclusive Airdrive Design.

These all-round series suites nearly all European freshwater species. The Airdrive Design improves balance as the centre of gravity is shifted backwards, sensitivity and feeling are improved and result into longer and more precise casting. The Airdrive Bail was completely redesigned and nearly fully eliminates line tangles on the bail arm. The ATD Type-L drag immediately works smooth in response to the pull of a fish and reduces line breakage – perfect for using thin lines or on fast pulls on short distance.

The Tough Digigear provides smooth rotation and perfect power transmission – ideal for fighting big fish. The BR mechanism can be adjusted very subtle and even copes with spooky fish such as trout, zander and eel.

- AIRDRIVE Design
- DS4 reel body
- DS4 body cover
- 3 ball bearings
- AIRDRIVE ROTOR®
- TOUGH DIGIGEAR®
- Infinite Anti-Reverse®
- ATD™ Type-L drag system
- Cross Wrap® system
- ABS® aluminum longcast spool
- AIRDRIVE BAIL
- Twist Buster® III line roller
- Aluminum handle
- T-Shape handle knob



Art.-No.	Size	BB total	Capacity m/mm	Ratio	Retrieval cm	Drag kg	Weight g
10162-250	2500	3	150/0.20	5.2:1	73	10.0	260
10162-300	3000	3	150/0.23	5.2:1	77	10.0	265
10162-400	4000-C	3	150/0.28	5.2:1	82	12.0	280
10162-500	5000-C	3	150/0.37	5.2:1	87	12.0	290



20 GS BR LT

COMPACT BITE'N RUN REEL

LT LIGHT TOUGH

AIR ROTOR

ATD
AUTOMATIC DRAG SYSTEM

After the overwhelming success of the DAIWA LT BR reels, DAIWA with the GS BR LT launched an additional compact BR reel with retro design, which has been optimized regarding numerous technical features.

The forged longcast ABS spool is very tough and offers optimum casting properties due to the special LC spool rim.

The ATD drag system works without starting resistance and provides the required sensitivity to land also large specimen after critical situations during the fight with the fish.

The aluminum One-Touch folding handle can be folded easily and thus allows to transport the rod fully rigged in a holdall.

- LT (Light & Tough)
- 4 ball bearings
- AIR ROTOR®
- TOUGH DIGIGEAR®
- Infinite Anti-Reverse®
- ATD™ drag system
- Finely adjustable free spool
- Cross Wrap® system
- Silent Oscillation® system
- ABS® aluminum longcast spool
- Twist Buster® II line roller
- One-touch aluminum fast snap handle
- Wooden handle knob



Art.-No.	Size	BB total	Capacity m/mm	Ratio	Retrieval cm	Drag kg	Weight g
10144-300	3000	4	150/0.23	5.2:1	77	12.0	310
10144-400	4000-C	4	150/0.28	5.2:1	82	12.0	320
10144-500	5000-C	4	150/0.37	5.2:1	87	12.0	330



19 BLACK WIDOW BR LT

COMPACT BITE'N RUN REEL

LT LIGHT TOUGH

SILENT OSCILLATION

TOUGH DIGIGEAR

ATD
AUTOMATIC DRAG SYSTEM

With the Black Widow BR LT, success is guaranteed.

Small compact free spool reels for all-round fishing at highest quality standards! Regardless if specimen hunting for zander, carp, eel or trout or medium-heavy feeder fishing – the Black Widow BR LT series is suited to cover almost any field of application due to its unique design.

The novel Tough Digigear design offers a better power transmission and higher drag power as well as a silky-smooth running. The ATD drag cares for instant working of the drag without starting resistance and offers huge drag power at the same time.

The longcast ABS spool features less friction at the spool's edge and thus increases the casting distance.

The free-spool system can be adjusted very precisely – perfect, when shy fish like trout, eel and zander should not feel any resistance when taking the bait.

We are fully convinced that these new BR reels from DAIWA will be a huge success for the coming season! The high quality Black Widow BR LT reels offer an outstanding price-performance ratio!

- LT (Light & Tough)
- 1 ball bearing
- TOUGH DIGIGEAR®
- Infinite Anti-Reverse®
- ATD™ drag system
- Finely adjustable free spool
- Cross Wrap® system
- Silent Oscillation® system
- ABS® aluminum longcast spool
- Twist Buster® II line roller
- CNC-machined aluminum handle
- Soft-touch handle knob



Art.-No.	Size	BB total	Capacity m/mm	Ratio	Retrieval cm	Drag kg	Weight g
10149-250	2500	1	150/0.20	5.2:1	73	10.0	295
10149-300	3000	1	150/0.23	5.2:1	77	12.0	300
10149-400	4000-C	1	150/0.28	5.2:1	82	12.0	320
10149-500	5000-C	1	150/0.37	5.2:1	87	12.0	315



EMBLEM BR 25 A

FREESPOOL REEL | WITH 25MM SPOOL STROKE

UTD[®] Drag
ULTIMATE TOURNAMENT DRAG

DIGIGEAR

AIR BAIL

AIR ROTOR

The Emblem BR represents Bite'N'Run reel construction at its finest!

The concept with a 25mm spool stroke enables the construction of a compact and lightweight reel, which combines the longcasting-benefits of a Big Pit reel. Due to the lighter weight you even can cast more precise and controlled compared to heavier Big Pit reels! The big spool diameter enables extremely long casting distances and – in combination with the transmission of 5.3:1 – a line retraction of more than one meter! Additionally, the manual bail turn reliably prevents an unwanted turning during the cast, which can lead to the loss of your rig at powerful casts.

The Bite'N'Run mechanism is extremely sensitive and can be perfectly adjusted to all kind of external influences (wind, current, etc.).

- 6 ball bearings
- AIR ROTOR[®]
- DIGIGEAR[®] II
- Infinite Anti-Reverse[®]
- UTD[®] drag system
- Finely adjustable free spool
- 25mm spool stroke
- HIP[®] line clip
- AIR BAIL[®]
- Twist Buster[®] II line roller
- Longlife bail spring
- CNC-machined aluminum handle
- Soft-touch handle knob
- Manual bail return

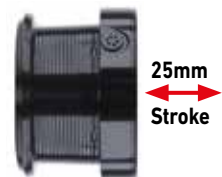

Art.-No.	Size	BB total	Capacity m/mm	Ratio	Retrieval cm	Drag kg	Weight g
10928-025	25	6	320/0.32	5.3:1	106	12.0	510



EMCAST BR A

FREESPOOL REEL

AIR BAIL

All one can expect from a BR reel! Amazing Bite'N Run reel, which runs extraordinary silent and smooth.

Thanks to the many available sizes and the extremely sensitive adjustable Bite'N Run mechanism, the Emcast BR reels are perfectly suited for fishing for zander and eel beneath their application within carp fishing.

This reel is delivered with a CNC cut aluminum handle and an additional double-handle. Depending on the individual taste, the matching handle can be used.

- 7 ball bearings
- Infinite Anti-Reverse®
- Aluminum spool
- Aluminum spare spool
- AIR BAIL®
- Twist Buster® II line roller
- Longlife bail spring
- CNC-machined aluminum handle
- Soft-touch handle knob



Art.-No.	Size	BB total	Capacity m/mm	Ratio	Retrieval cm	Weight g
10152-350	3500	7	250/0.28	4.6:1	79	470
10152-400	4000	7	270/0.30	4.6:1	79	460
10152-450	4500	7	370/0.30	4.6:1	86	490
10152-500	5000	7	370/0.32	4.6:1	86	480



BLACK WIDOW BR A

FREESPOOL REEL

AIR BAIL

The entrance to the DAIWA BR world.

Matching with the popular rod series, the brand Black Widow is now also present within the DAIWA Bite'N Run reel range. Thanks to the sensitive adjustable Bite'N Run mechanism, this series is suited for a wide application range like fishing for carp, eel, and zander.

With the Black Widow BR reels you get the familiar DAIWA quality according to Japanese standards at an excellent price-performance ratio.

- 3 ball bearings
- Infinite Anti-Reverse®
- Aluminum spool
- AIR BAIL®
- Twist Buster® II line roller
- Longlife bail spring
- Aluminum handle
- Soft-touch handle knob



Art.-No.	Size	BB total	Capacity m/mm	Ratio	Retrieval cm	Weight g
10153-350	3500	3	220/0.30	4.6:1	79	470
10153-400	4000	3	200/0.35	4.6:1	79	460
10153-450	4500	3	270/0.35	4.6:1	86	490
10153-500	5000	3	230/0.40	4.6:1	86	480



BIG PIT REELS



20 TOURNAMENT BASIA 45 SCW QD

BIG PIT REEL | WITH 45MM SPOOL STROKE

QD **ZAION** AIR ROTOR **MAGSEALED** **DIGIGEAR**

With the high-end model Tournament Basia 45 SCW QD from Japan DAIWA once again impressively shows what can be attained when latest manufacturing technology meets technical know-how. The dualism of technical precision and the distinct design leads to an eye-candy that represents a new benchmark at carp fishing.

The Zaion body is in charge for an optimal housing of the gear and cares for permanent silky-smooth running. The CNC-cut gear, made of aircraft-grade aluminum, offers huge retrieving power and facilitates lifting of heavy rigs also over long distances. The strong axis bears enough power reserves also at highest strains to guide even large specimen securely to the net.

The special longcast spool rim reduces friction at the cast and allows longer casting distances.



- ZAION® reel body
- MagSealed® body construction
- 9 ball bearings
- ZAION® AIR ROTOR®
- CNC-machined TOUGH DIGIGEAR®
- Stainless steel axis
- Infinite Anti-Reverse®
- QD® Quick drag system
- SCW (Slow Cross Wrap®) system
- Silent Oscillation® system
- 45mm spool stroke
- ABS® aluminum longcast spool
- Aluminum spare spool
- HIP® line clip
- One-piece AIR BAIL®
- Twist Buster® II line roller
- CNC-machined aluminum handle
- Wooden handle knob
- Manual bail return
- Made in Japan

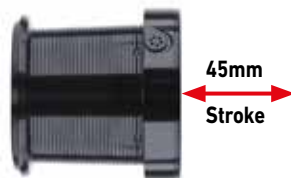

Art.-No.	Size	BB total	Capacity m/mm	Ratio	Retrieval cm	Drag kg	Weight g
10121-050	45-5000C	9	300/0.35	4.9:1	104	10.0	520



17 BASIA 45 SLD QD

BIG PIT REEL | WITH 45MM SPOOL STROKE

QD **ZAION** DIGIGEAR
AIR ROTOR

BLACK is beautiful! Decent Big Pit carp reel for long distance fishing.

The decent black design with wooden handle knob makes this Big Pit reel a real highlight. Additionally the Basia 45 SLD QD has been completely revised and adopted for the European market.

The spool has been milled somewhat deeper to enhance the line capacity – the new spool now offers space for 300m 0.35mm! The main shaft is made of stainless steel and is considerably tougher than at the previous model. Further the Basia 45 SLD QD model is delivered including a spare spool.

The Basia 45 SLD QD is manufactured in our Japanese factory according to highest quality standards.

- AIR METAL® magnesium reel body
- 8 ball bearings
- ZAION® AIR ROTOR®
- CNC-machined DIGIGEAR® II
- Stainless steel axis
- Infinite Anti-Reverse®
- QD® Quick drag system
- Wormshaft oscillation system
- 45mm spool stroke
- Aluminum longcast spool
- Aluminum spare spool
- HIP® line clip
- AIR BAIL®
- Twist Buster® II line roller
- Longlife bail spring
- CNC-machined aluminum handle
- Wooden handle knob
- Manual bail return
- Made in Japan



Art.-No.	Size	BB total	Capacity m/mm	Ratio	Retrieval cm	Drag kg	Weight g
10121-045	45-5000C	8	300/0.35	4.1:1	87	10.0	485



19 BASIA 45 SCW QD

BIG PIT REEL | WITH 45MM SPOOL STROKE

QD **ZAION** **AIR BAIL** **TOUGH DIGIGEAR**

Top class carp reel! The Basia 45 SCW QD unites almost all technical attributes, which are required from a premium and tough carp reel.

The lightweight Zaion reel body is the foundation of the securely housed gear and guarantees permanently smooth running while the thick axis is milled of special stainless steel and easily resists the high strains of long range carp fishing.

The Slow Cross Wrap line lay teaming up with the longcast spool edge is a key requirement for the elevation to the next level of casting performances.

The CNC cut Tough Digigear provides the groundwork for the enormous power transmission during the fight and allows the retrieving of large rigs with ease.

The included spare spool features a line capacity of 530m/0.35mm mono line – thus the Basia 45 SCW QD is also ideally suited for long-range fishing at large waters!

- ZAION® reel body
- 7 ball bearings
- CNC-machined TOUGH DIGIGEAR®
- Infinite Anti-Reverse®
- QD® Quick drag system
- SCW (Slow Cross Wrap®) system
- 45mm spool stroke
- Ultra aluminum longcast spool
- Aluminum spare spool
- HIP® line clip
- AIR BAIL®
- Twist Buster® II line roller
- CNC-machined aluminum handle
- Soft-touch handle knob
- Manual bail return
- Made in Japan



For the Basia 45 SCW QD two spare spools with different line capacity are available.

Spool art.-no. 19121-048 (300m/ø0.35mm)

Spool art.-no. 19121-049 (530m/ø0.35mm)

Art.-No.	Size	BB total	Capacity m/mm	Ratio	Retrieval cm	Drag kg	Weight g
10121-048	45-5000C/LD	7	300/0.35	4.9:1	104	15.0	515



20 WHISKER 25 QD

BIG PIT REEL | WITH 25MM SPOOL STROKE

QD **ZAION** AIR ROTOR **MAGSEALED**

With the Whisker 25 QD you get a compact and light power reel with the features of a real Big Pit reel.

Reels with 25mm spool stroke have become the prevailing choice for carp fishing over short and medium distances in the last years. The combination of a large and extra-wide spool with a small and compact body allows the design of lightweight and very tough reels with optimum casting characteristics. The special design of the spool rim has been matched with the properties of the spool cone leading to minimum line friction at the cast, thereby reducing the threat of tanglings significantly.

- ZAION® reel body
- MagSealed® body construction
- 7 ball bearings
- AIR ROTOR®
- DIGIGEAR® II
- Infinite Anti-Reverse®
- QD® Quick drag system
- Silent Oscillation® system
- 25mm spool stroke
- Aluminum spare spool
- HIP® line clip
- AIR BAIL®
- Twist Buster® II line roller
- One-touch aluminum fast snap handle
- Soft-touch handle knob
- Manual bail return

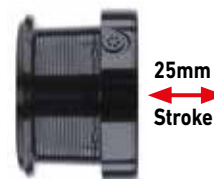
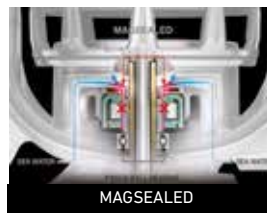

Art.-No.	Size	BB total	Capacity m/mm	Ratio	Retrieval cm	Drag kg	Weight g
10930-025	25	7	300/0.35	4.7:1	96	12	450



22 WHISKER 45 SCW QD OT

BIG PIT REEL | WITH 45MM SPOOL STROKE

QD DIGIGEAR CROSS WRAP

Big Pit power reel with 45mm spool stroke and 2 spare spools.

The Whisker 45 SCW QD OT offers enormous casting distances and combines nearly all requirements of modern carp fishing. The extra-large Digigear II driving wheel cares for an optimal power transmission and smooth running. The extra-strong aluminum axis provides extreme resilience and enormous power reserves even over great distances to allow clear directives during the fight with the fish. Thanks to two included spare spools (530m/Ø0.35mm and 700m/Ø0.35mm), you can perfectly adjust to different waters and fishing situations with only one reel. With the QDM drag system you can finely tune the drag to improve control over the fish during the fight. The aluminum foldable handle makes it easy to transport the rigged rod within the holdall.

- 7 ball bearings
- ZAION V® AIR ROTOR®
- DIGIGEAR® II
- Infinite Anti-Reverse®
- QDM drag system
- SCW (Slow Cross Wrap®) system
- 45mm spool stroke
- Forged aluminum longcast spool
- 2 aluminum spare spools
- HIP® line clip
- Twist Buster® II line roller
- One-touch aluminum fast snap handle
- Soft-touch handle knob
- Manual bail return

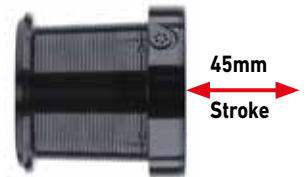

Art.-No.	Size	BB total	Capacity m/mm	Ratio	Retrieval cm	Drag kg	Weight g
10930-500	45	7	300/0.35	4.9:1	104	15.0	645



21 EMBLEM 45 SCW QD SD

BIG PIT REEL | WITH 45MM SPOOL STROKE

QD DIGIGEAR

Long-range model for distance fishing especially in large waters.

With the Emblem 45 SCW QD Big Pit reel with Super Deep spool you are perfectly equipped for targeting far remote spots. The line capacity of 700m 0.35mm monofilament line offers optimal prerequisites to perform on the right spots also at large lakes and river dams!

By using the new QDM drag system you can adjust the drag power more delicately, perfect for fights with the fish over long distances. The extra-strong stainless-steel axis is extremely durable and offers enough reserves to master also combats with large specimen over long ranges.

The perfect reel for large waters in Germany, France, Austria and Italy!

The included spare spool of the Emblem 45 SCW QD holds 530m/Ø0.35mm. In the spare spool registry Art. no. 19158-700SD.

- 4 ball bearings
- AIR ROTOR®
- DIGIGEAR® II
- Infinite Anti-Reverse®
- QDM drag system
- SCW (Slow Cross Wrap®) system
- 45mm spool stroke
- Ultra aluminum longcast spool
- Aluminum spare spool
- HIP® line clip
- Twist Buster® II line roller
- One-touch fast snap handle
- Wooden handle knob
- Manual bail return

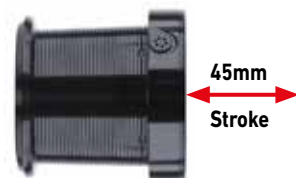

Art.-No.	Size	BB total	Capacity m/mm	Ratio	Retrieval cm	Drag kg	Weight g
10158-700	45-5000SD	4	700/0.35	4.9:1	104	15.0	645



23 EMBLEM SURF 45 SCW QD

BIG PIT REEL | WITH 45MM SPOOL STROKE

ZAION V
AIR ROTOR

SLOW
CROSS WRAP

MAGSEALED

The surfcast reel with Magsealed design and 45mm stroke.

The 45mm stroke together with the Slow Cross Wrap (SCW) line lay leads to extreme casting distances and optimal line management. Due to the Slow Cross Wrap line lay and the special longcast spool with optimized spool rim the friction at casting is minimized, leading to longer casts. The strong Digigear II together with the distortion-proof rotor made of Zaion V material offers optimal power transmission under load and supports retrieving heavy rigs over long distances.

The Magsealed design at the shaft prevents the intrusion of saltwater and dirt particles and therefore elevates the lifespan.

The new QDM drag features a somewhat longer adjusting length than the previous version and can be adjusted very precisely – perfect for adopting to changing conditions at fishing and during the fight within seconds.



- ZAION V® reel body
- MagSealed® body construction
- 6 ball bearings
- ZAION V® AIR ROTOR®
- DIGIGEAR® II
- Infinite Anti-Reverse®
- QDM drag system
- SCW (Slow Cross Wrap®) system
- 45mm spool stroke
- ABS® aluminum longcast spool
- Spare spool
- HIP® line clip
- AIR BAIL®
- Twist Buster® II line roller
- Machined aluminum handle
- T-Shape handle knob
- Manual bail return



Art.-No.	Size	BB total	Capacity m/mm	Ratio	Retrieval cm	Drag kg	Weight g
10711-450	Surf 45 SCW QD	6	300/0.30	4.9:1	104	15.0	605



23 EMBLEM 45 SCW QD-OT

BIG PIT REEL | WITH 45MM SPOOL STROKE

ZAION V
AIR ROTOR

SLOW
CROSS WRAP

The classic with 45mm stroke and new folding handle.

The 23' Emblem 45 SCW QD OT offers nearly the same equipment like the Emblem 45 SCW QD and additionally features a newly invented quick-fold handle that has even fewer play than at the previous edition.

The new QDM drag features a somewhat longer adjusting length than the previous version and can be adjusted very precisely – perfect, to adapt to changing conditions at fishing and during the fight within seconds.

The 45mm stroke together with the Slow Cross Wrap (SCW) line lay leads to extreme casting distances and optimal line management. Due to the Slow Cross Wrap line lay and the special longcast spool with optimized spool rim the friction at casting is minimized, leading to longer casts. The strong Digigear II gear together with the distortion-proof rotor made of Zaion V material offers optimal power transmission under load and supports retrieving heavy rigs over long distances. The extra-tough shaft made of stainless steel ensures a high durability during the fight and offers enormous power reserves.

The reel is delivered with a deep spare spool with 530m/0.35mm line capacity and therefore is perfectly suited for long range fishing at large waters.



- ZAION V® reel body
- ZAION V® body cover
- 4 ball bearings
- ZAION V® AIR ROTOR®
- DIGIGEAR® II
- QDM drag system
- SCW (Slow Cross Wrap®) system
- 45mm spool stroke
- ABS® aluminum longcast spool
- HIP® line clip
- Twist Buster® II line roller
- Machined aluminum handle
- Wooden handle knob
- Manual bail return



Art.-No.	Size	BB total	Capacity m/mm	Ratio	Retrieval cm	Drag kg	Weight g
10158-649	45SCW QD-OT	4	350/0.35	4.9:1	104	15.0	635



23 SUPERSPOD 45 SCW QD-OT

BIG PIT REEL | WITH 45MM SPOOL STROKE

ZAION V
AIR ROTOR

SLOW
CROSS WRAP

Extra-strong Spod reel with 45mm longcast spool.

Due to numerous new restrictions at fishing waters spodding is getting increasingly popular. With the proper combo it is possible to accurately establish your feeding spot also over a distance of 100m.

Thanks to the 45mm spool in combination with the special spool rim the new 23' Superspod offers exactly the requirements for extreme casting distances.

The two HIP metal line clips allow easy handling for accurate casts to the feeding spot and permanently take care of the line. The Digigear II is highly durable and together with the distortion-proof Zaion V rotor offers the optimal power transmission for retrieving large bait rockets.

- 6 ball bearings
- ZAION V® AIR ROTOR®
- DIGIGEAR® II
- QDM drag system
- SCW (Slow Cross Wrap®) system
- 45mm spool stroke
- Aluminum longcast spool
- HIP® line clip (double)
- Twist Buster® II line roller
- Machined aluminum handle
- T-Shape handle knob
- Manual bail return

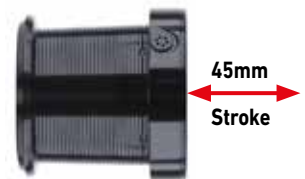

Art.-No.	Size	BB total	Capacity m/mm	Ratio	Retrieval cm	Drag kg	Weight g
10158-505	45 SCW QD-OT	6	300/0.35	5.5:1	118	15.0	620



23 EMBLEM 45 SCW QD

BIG PIT REEL | WITH 45MM SPOOL STROKE

QD

ZAION
AIR ROTOR

DIGIGEAR

SLOW
CROSS WRAP

The longcast reel with 45mm stroke.

The 23rd Emblem offers exclusive DAIWA technology at an extraordinary price-performance ratio. The 45mm stroke together with the Slow Cross Wrap (SCW) line lay leads to extreme casting distances and optimal line management. Due to the Slow Cross Wrap line lay and the special longcast spool with optimized spool rim the friction at casting is minimized, leading to longer casts. The strong Digigear II gear together with the distortion-proof rotor made of Zaion V material offers optimal power transmission under load and supports retrieving heavy rigs over long distances. The extra-tough shaft made of stainless steel ensures a high durability during the fight and offers enormous power reserves.

The new QDM drag features a somewhat longer adjusting length than the previous version and can be adjusted very precisely – perfect, to adapt to changing conditions at fishing and during the fight within seconds.

The reel is delivered with a deep spare spool with 530m/0.35mm line capacity and therefore is perfectly suited for long range fishing at large waters.



- 6 ball bearings
- ZAION V® AIR ROTOR®
- DIGIGEAR® II
- QDM drag system
- SCW (Slow Cross Wrap®) system
- 45mm spool stroke
- ABS® aluminum longcast spool
- HIP® line clip
- Twist Buster® II line roller
- Machined aluminum handle
- T-Shape handle knob
- Manual bail return



Art.-No.	Size	BB total	Capacity m/mm	Ratio	Retrieval cm	Drag kg	Weight g
10158-800	45 SCW QD	6	300/0.35	4.9:1	104	15.0	620



23 EMBLEM 35 SCW QD

BIG PIT REEL | WITH 35MM SPOOL STROKE

QD

ZAION
AIR ROTOR

DIGIGEAR

SLOW
CROSS WRAP

The legend – with Zaion V rotor and QDM drag knob.

This compact Big Pit reel for carp fishing offers huge retrieving power thanks to the Digigear II. The Slow Cross Wrap line lay enables an almost friction-less release of the line during casting leading to large casting distances. The distortion-proof rotor is made of Zaion V material and together with the large driving wheel with extra-large teeth supports convenient retrieving of heavy rigs over long distances thanks to the optimal power transmission.

The new QDM drag features a somewhat longer adjusting length than the previous version and can be adjusted very precisely – perfect, to adopt to changing conditions at fishing and during the fight within seconds.

The reel is delivered with a deep spare spool with 530m/0.35mm line capacity and therefore is perfectly suited for long range fishing at large waters.

- 6 ball bearings
- ZAION V® AIR ROTOR®
- DIGIGEAR® II
- QDM drag system
- SCW (Slow Cross Wrap®) system
- 35mm spool stroke
- ABS® aluminum longcast spool
- HIP® line clip
- Twist Buster® II line roller
- Machined aluminum handle
- T-Shape handle knob

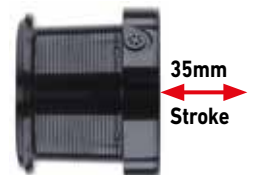

Art.-No.	Size	BB total	Capacity m/mm	Ratio	Retrieval cm	Drag kg	Weight g
10158-635	35 SCW QD	6	300/0.35	4.9:1	103	15.0	570



18 EMBLEM SPOD 35 SCW QD

BIG PIT REEL | WITH 35MM SPOOL STROKE

QD DIGIGEAR AIR ROTOR SILENT OSCILLATION

Particularly designed for spodding and equipped with the newest Slow Cross Wrap line laying system.

The Emblem Spod is a synonym for highest durability and toughness at spodding for years now.

The Emblem Spod 35 SCW QD has been updated regarding the latest technology and now also offers the SCW line lay. In combination with the longcast edge, the casting distance is thus additionally increased. Both metal HIP line clips enable an easy handling during exact casts to the feeding spot and protect the line. The bail is turned by hand to prevent unwanted turning during the cast.

The 90mm aluminum power handle optimizes the power transmission during retrieving and offers tremendous power reserves to retrieve even big spods over great distances fast and easily.

We are sure – with the Emblem Spod 35 SCW QD DAIWA developed an equal or even better successor, which endures the high strains during spodding without problems.

- 6 ball bearings
- AIR ROTOR®
- DIGIGEAR® II
- Infinite Anti-Reverse®
- QD® Quick drag system
- SCW (Slow Cross Wrap®) system
- Silent Oscillation® system
- 35mm spool stroke
- HIP® line clip (double)
- Twist Buster® II line roller
- CNC-machined aluminum handle
- Soft-touch handle knob
- Manual bail return



Art.-No.	Size	BB total	Capacity m/mm	Ratio	Retrieval cm	Drag kg	Weight g
10158-606	35-5000C	6	300/0.35	5.5:1	124	15.0	640



24 CROSSCAST 45 SCW QD

NEW

BIG PIT REEL | WITH 45MM SPOOL STROKE

QD

ZAION
AIR ROTOR

DIGIGEAR

SLOW
CROSS WRAP

DAIWA's Big Pit Technology for a top price!

The 24 Crosscast impresses with its light and smooth rotation and high cranking power. The 45mm stroke in combination with the special long cast spool lip ensures enormous casting distances and easy operation. The lightweight Air Rotor made of Zaion V material is extremely torsion-resistant and starts up with very low inertia. The extra-strong stainless-steel shaft even copes the heaviest loads and always offers the reliability of successfully defeating strong and powerful fighting fish such as catfish. The HIP line clip protects the line and is ideal if the feeding spot must be reached frequently.

- 4 ball bearings
- ZAION V® AIR ROTOR®
- DIGIGEAR® II
- Infinite Anti-Reverse®
- QDM drag system
- SCW (Slow Cross Wrap®) system
- 45mm spool stroke
- Aluminum longcast spool
- HIP® line clip
- Twist Buster® II line roller
- Machined aluminum handle
- T-Shape handle knob
- Manual bail return

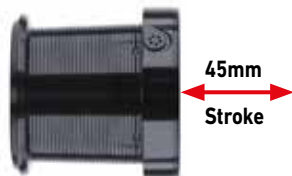

The QD drag secures fast adjustment to changing fishing conditions and individual preferences.

The reel is supplied with a „No Paint“ unpainted surface – that eliminates the risk of cracked and chipped coating even after long periods of use.

Art.-No.	Size	BB total	Capacity m/mm	Ratio	Retrieval cm	Drag kg	Weight g
10252-500	5000C	4	300/0.35	4.9:1	104	15.0	600
10252-501	5000LD	4	530/0.35	4.9:1	104	15.0	600



21 CROSSCAST 45 SCW QD OT

BIG PIT REEL | WITH 45MM SPOOL STROKE

QD DIGIGEAR AIR ROTOR **SLOW CROSS WRAP**

Big Pit carp reel with retro design.

The Crosscast 45 SCW QD OT convinces by latest technology and maximum casting distances. The Tough Digigear offers ultimate smoothness and high retrieving power. The extra-strong axis offers enough power reserves to direct even large carps and catfish during the fight. By using the QD drag system you can quickly adopt to every fishing situation at the water. The longcast spool rim in combination with the SCW cross wrap reduces the friction during the cast and cares for increased casting distances. The One-Touch folding handle can be operated quick and easy, ensuring a convenient transportation of the rigged rod in the holdall.

- 3 ball bearings
- AIR ROTOR®
- DIGIGEAR® II
- QDM drag system
- SCW (Slow Cross Wrap®) system
- 45mm spool stroke
- Aluminum longcast spool
- HIP® line clip
- Twist Buster® II line roller
- One-touch fast snap handle
- Wooden handle knob
- Manual bail return



Art.-No.	Size	BB total	Capacity m/mm	Ratio	Retrieval cm	Drag kg	Weight g
10250-505	5000C	3	300/0.35	4.9:1	104	15.0	640
10250-605	5000LD	3	530/0.35	4.9:1	104	15.0	640



20 CROSSCAST SPOD 45 SCW QD

BIG PIT REEL | WITH 45MM SPOOL STROKE

QD DIGIGEAR

With the Crosscast Spod with 45mm spool stroke DAIWA offers an ultimately tough Big Pit reel for the use of heavy spods, spombs, large PVA bags etc.

By combining the longcast spool with a 45mm spool stroke also large weights can be cast to far remote spots. The HIP metal line clip spares the line and is perfectly suited for accurate and frequent targeting of fishing spots with heavy spods.

- 3 ball bearings
- DIGIGEAR® II
- Infinite Anti-Reverse®
- QD® Quick drag system
- SCW (Slow Cross Wrap®) system
- 45mm spool stroke
- Aluminum longcast spool
- HIP® line clip
- Twist Buster® II line roller
- Longlife bail spring
- Aluminum handle
- Manual bail return

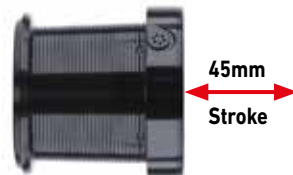

Compatible with QDM drag knob (art.-no. 10158-000). QDM drag knob separately available.

Art.-No.	Size	BB total	Capacity m/mm	Ratio	Retrieval cm	Drag kg	Weight g
10128-610	45-5000C	3	300/0.35	5.5:1	118	15.0	610



24 CROSSCAST SURF 45 SCW QD

NEW

BIG PIT REEL | WITH 45MM SPOOL STROKE

QD

ZAION
AIR ROTOR

DIGIGEAR

SLOW
CROSS WRAP

The surf cast reel for distance casting!

The 24 Crosscast Surf 45 SCW QD basically offers the same feature as the carp version of the Crosscast 45 SCW QD series. The 45mm stroke provides outstanding casting distances and the Slow Cross Wrap (SCW) line lay improves casting distance and is especially suitable for thin braids and monofilaments. Thanks to the Air Rotor made by Zaion V, inertia is reduced, and sensitivity improved. The powerful Digigear II provides perfect winding power and even heavy rigs weighing over 200g can be retrieved with ease.

- 3 ball bearings
- ZAION V® AIR ROTOR®
- DIGIGEAR® II
- Infinite Anti-Reverse®
- QDM drag system
- SCW (Slow Cross Wrap®) system
- Aluminum longcast spool
- HIP® line clip
- Twist Buster® II line roller
- CNC-machined aluminum handle
- T-Shape handle knob



Art.-No.	Size	BB total	Capacity m/mm	Ratio	Retrieval cm	Drag kg	Weight g
10255-500	45SCW 5000C	3	300/0.35	4.9:1	104	15.0	600



20 CROSSCAST 35 SCW LD QD

BIG PIT REEL | WITH 35MM SPOOL STROKE

QD DIGIGEAR

Power reel at an excellent price for long distance spod fishing.

The Crosscast SCW LD QD with 35mm spool stroke now is also equipped with the Slow Cross Wrap line lay.

Due to the transmission of 4.9:1 you get a real power gear, which develops enormous retrieving power. The solid stainless-steel axis offers highest resilience. The Digigear II ensures an enduring smooth running and an optimal power transmission.

The HIP line clip protects the line and is optimally suited for exact, repeating cast to your feeding spot.

The Crosscast 35 SCW 5000 LD QD is available at an excellent price-performance-ratio!



- 3 ball bearings
- AIR ROTOR®
- DIGIGEAR® II
- Infinite Anti-Reverse®
- QD® Quick drag system
- SCW (Slow Cross Wrap®) system
- 35mm spool stroke
- Aluminum longcast spool

- HIP® line clip
- Twist Buster® II line roller
- Longlife bail spring
- Aluminum handle
- Soft-touch handle knob
- Manual bail return

Art.-No.	Size	BB total	Capacity m/mm	Ratio	Retrieval cm	Drag kg	Weight g
10128-609	35-5000LD	3	530/0.35	4.9:1	103	15.0	625



QDM DRAG KNOB

The QDM drag knob allows you to decrease the drag sensitivity of your QD Big Pit reels. You can change the drag from open to closed via a 3/4 turn while the usual QD drag performance only needs 1/4 turn. Fitting for all Emblem 45 and 35, Crosscast 45 and 35 and Whisker 45 SCW QD reels.

Art.-No.
10158-000



24 VERTICE

NEW

BIG PIT REEL | WITH 35MM SPOOL STROKE

QD AIRBAIL

The price-performance winner among the big pit series with 35mm stroke!

This classic car reel with 35mm stroke combines timeless design with quality components. The conical shaped long cast aluminium spool supports long casting distance. Due to the power gears low ratio, even heavy rigs can easily and fast be retrieved. The reel offers excellent winding power once fighting a fish and easily copes with large fish.

Thanks to the compact body, the 24 Vertice is the perfect match for 10ft. Stalker rods as well.

- 5 ball bearings
- Infinite Anti-Reverse®
- QD® Quick drag system
- 35mm spool stroke
- Aluminum longcast spool
- AIR BAIL®
- Twist Buster® II line roller
- Machined aluminum handle
- T-Shape handle knob

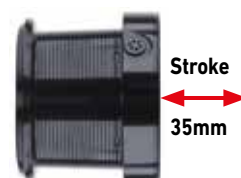

Art.-No.	Size	BB total	Capacity m/mm	Ratio	Retrieval cm	Drag kg	Weight g
10131-500	5000C	5	300/0.35	4.1:1	89	10.0	660
10131-501	5000LD	5	530/0.35	4.1:1	89	10.0	660





BLACK WIDOW 35 A

BIG PIT REEL | WITH 35MM SPOOL STROKE

After the great success of the Black Widow Bite'N Run reels with the Black Widow 35 A DAIWA presents a Big Pit reel with a large, conical spool and a 35mm spool stroke.

Due to the special production process and the selected material, DAIWA can offer you a reel with high retrieving power and optimal distortion-proofness at an outstanding price-performance ratio.

Depending on the model, the line capacity is up to 530m/0.35mm monofilament.

- 1 ball bearing
- Infinite Anti-Reverse®
- 35mm spool stroke
- Aluminum longcast spool
- Longlife bail spring
- Soft-touch handle knob
- Manual bail return

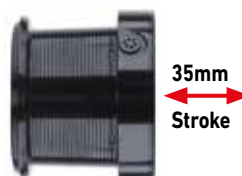

35mm
Stroke

Art.-No.	Size	BB total	Capacity m/mm	Ratio	Retrieval cm	Drag kg	Weight g
10155-550	35-5500	1	460/0.35	4.1:1	85	10.0	675
10155-600	35-5000LD	1	530/0.35	4.1:1	85	10.0	675



BLACK WIDOW 25 A

BIG PIT REEL | WITH 25MM SPOOL STROKE

With the Black Widow 25 A the DAIWA engineers designed a distortion-proof reel with high winding power, which features an outstanding price-performance ratio.

The Black Widow 25 A with a 25mm spool stroke convinces especially at carp fishing over medium distances and near the shore. For this purpose the line capacity of 270m/0.35mm offers enough reserves.

- 1 ball bearing
- Infinite Anti-Reverse®
- 25mm spool stroke
- Conical aluminum longcast spool
- Twist Buster® II line roller
- Longlife bail spring
- Aluminum handle
- Manual bail return

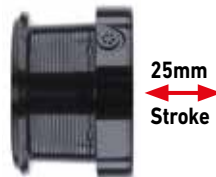

Art.-No.	Size	BB total	Capacity ml/mm	Ratio	Retrieval cm	Drag kg	Weight g
10133-225	25	1	370/0.30	4.6:1	92	8.0	517



SEA FISHING REELS



20 SALTIGA

SALTWATER SPINNING REEL



MAG SEALED



Highest-quality construction, maximum strength and extreme casting performance are just a few of the superlatives of the latest Saltiga.

The Saltiga is not less than the dawn of a new age at heavy sea fishing. With this reel, angler dreams are coming true. The application of a high-tech monocoque body combined with an ultimate design fully convinces.

By integrating all new pioneering DAIWA technologies, we can guarantee that the 20' Saltiga represents the strongest Saltiga in history.

- MQ® Monocoque aluminum reel body
- MagSealed® body construction
- 12 ball bearings (incl. 6 CRBB® & 2 MagSealed® BB)
- HARDBODYZ® AIR ROTOR®
- CNC-machined duralumin gear
- Infinite Anti-Reverse®
- ATD™ drag system
- 14 carbon drag discs
- Cross Wrap® system
- ABS® aluminum longcast spool
- One-piece AIR BAIL®
- MagSealed® line roller
- CNC-machined aluminum handle
- Manual bail return

Further fittings:

- Equipped with radiation aluminum drag knob



Art.-No.	Size	BB MSBB	BB CRBB	BB total	Capacity m/mm	Ratio	Retrieval cm	Drag kg	Weight g
10310-080	8000-H	2	6	12	300/0.33	5.8:1	111	25.0	655
10310-100	10000-H	2	6	12	300/0.37	5.8:1	118	25.0	655
10310-101	10000-P	2	6	12	300/0.37	4.8:1	98	25.0	645
10310-140	14000-XH	2	6	12	300/0.40	6.2:1	134	25.0	665
10310-141	14000-P	2	6	12	300/0.40	4.8:1	104	25.0	655
10310-180	18000-H	2	6	12	300/0.47	5.8:1	127	30.0	885
10310-200	20000-H	2	6	12	300/0.52	5.8:1	143	30.0	890



SALTIGA

M A D E I N F I E L D



23 SALTIGA

SALTWATER SPINNING REEL

AIRDRIVE
DESIGN

MQ

MAGSEALED

ATD
AUTOMATIC DRAG SYSTEM



The small Saltiga reels offer huge power and top-level Japanese technology.

Together with the aluminum MQ reel body the new Airdrive Design cares for highest durability and sensitivity – perfect, when strong fighters, like halibut, tuna, amberjack or GT are targeted with rather light tackle.

The Airdrive Rotor leads to decreased weight at the front unit of the reel, optimizing the rod balance – an improved casting performance and optimized sensitivity at lure presentation are the result. Reduction of the rotor weight further led to a decreased starting resistance, further optimizing reaction and sensitivity.

The hollow one-piece Airdrive bail cares for an optimal line management and reduces the threat of tanglings at casting.

The CNC cut driving wheel is made of G1 Duraluminum and has been especially coated for an even softer and smoother running than usual. The Airdrive Shaft creates a low-contact structure at the pinion gear, minimizing the friction resistance at the shaft and leading to a silky-smooth, almost completely silent functioning of this reel. The Monocoque design of the reel body allows the use of a larger gear unit with better power transmission and a longer lifespan under high load. The distortion-proof reel body cares for an optimal housing of the gear and permanent smooth running.

At both sides of the crank axle Magsealed ball bearings prevent the intrusion of saltwater and dust particles, leading to a tremendous level of protection together with the Magsealed shaft.



- AIRDRIVE Design
- MQ® Monocoque aluminum reel body
- MagSealed® body construction
- 12 ball bearings (incl. 7 CRBB® & 2 MagSealed® BB)
- AIRDRIVE ROTOR®
- CNC-machined G1 duralumin TOUGH DIGIGEAR®
- Infinite Anti-Reverse®
- ATD™ drag system
- 10 drag discs (5 carbon)
- Cross Wrap® system
- ABS® aluminum longcast spool
- AIRDRIVE BAIL
- MagSealed® line roller
- CNC-machined aluminum handle
- Round aluminum handle knob
- Manual bail return



Art.-No.	Size	BB MSBB	BB CRBB	BB total	Capacity m/mm	Ratio	Retrieval cm	Drag kg	Weight g
10310-040	4000-H	2	7	12	150/0.37	5.7:1	90	12.0	345
10310-050	5000-H	2	7	12	150/0.40	5.7:1	96	15.0	365
10310-060	6000-H	2	7	12	150/0.43	5.7:1	101	15.0	400
10310-061	6000-XH	2	7	12	150/0.43	6.2:1	110	15.0	400



CERTATE

S A L T W A T E R





24 CERTATE SW

NEW

SALTWATER SPINNING REEL

**AIRDRIVE
DESIGN**

ATD

MQ

The smaller sizes of the Certate SW are now also available with Airdrive Design!

The 24 Certate SW sea fishing reels combine perfect resilience with a maximum of user-friendliness. Thanks to the Airdrive rotor made of Zaiion material, a lighter rotor can be used, that reduces inertia and increases sensitivity. The hollow Airdrive bail ensures less line tangling thanks to the newly designed bail arm and provides easier operation, especially in windy conditions. The Airdrive Shaft reduces the contact surface of the shaft with the pinion gear and ensures a very smooth rotation.

The extra-large, machined Tough Digigear gear includes oversized gear teeth and easily copes the high pressures of sea fishing. The MQ construction on the aluminium body ensures perfect power transmission and torsional strength. The Magsealed construction on the line roller and the main shaft prevents intruding salt water and dust particles and greatly reduces possible corrosion inside the body. The ATD drag with carbon washers can withstand even the hardest pulls. With round EVA power crank knob.

- AIRDRIVE Design
- MQ® Monocoque aluminum reel body
- 10 ball bearings (incl. 5 CRBB®)
- ZAIION® AIRDRIVE ROTOR
- CNC-machined duralumin gear
- ATD™ drag system
- AIRDRIVE ABS® longcast spool
- AIRDRIVE BAIL
- Twist Buster® III line roller
- Round Hard EVA handle knob
- Made in Japan

Drag:

Size 4000 is equipped with 3 carbon washers.
 Sizes 5000/6000 are equipped with 5 carbon washers.



Art.-No.	Size	BB CRBB	BB total	Capacity m/mm	Ratio	Retrieval cm	Drag kg	Weight g
10316-400	4000-H	5	10	150/0.37	5.7:1	90	12.0	335
10316-401	4000-XH	5	10	150/0.37	6.2:1	98	12.0	335
10316-500	5000-H	5	10	150/0.40	5.7:1	96	15.0	345
10316-501	5000-XH	5	10	150/0.40	6.2:1	104	15.0	345
10316-600	6000-H	5	10	150/0.43	5.7:1	101	15.0	375
10316-601	6000-XH	5	10	150/0.43	6.2:1	110	15.0	375



21 CERTATE SW

SALTWATER SPINNING REEL



MAGSEALED



Durable big fish reel with distortion-proof Monocoque body for all extreme conditions at sea fishing.

With the Certate SW DAIWA offers an extremely durable saltwater reel for ambitions fishing adventures in the tropics and for halibut in Norway. Enabled by the MQ design the traction wheel is enlarged by up to 40% compared with conventional reels of this size, increasing power transmission and lifespan considerably. By enlarging the teeth in the driving wheel, also the lifespan of the gear is further improved and the MQ design cares for an optimal and distortion-proof housing of the gear within the body. The special coating procedure prevents corrosion under the paint layer. The ATD drag system features premium carbon fiber drag discs and ensures optimum drag performance under strain and without high starting resistance, which additionally enlarges the lifespan, also when frequently applied for extra-tough fights – perfect for medium-sized Tunas, Doggies and GT! With extra-loud drag clicker!

- MQ® Monocoque aluminum reel body
- MagSealed® body construction
- ZAION® AIR ROTOR®
- CNC-machined G1 duralumin TOUGH DIGIGEAR®
- Permanent Infinite Anti-Reverse®
- ATD™ drag system
- Carbon drag discs
- Cross Wrap® system
- Cold forged ABS® aluminum longcast spool
- AIR BAIL®
- Machined screw-in aluminum handle
- From size 8000 - manual bail return
- Made in Japan



Equipment:

Ball bearings

Sizes 8000 to 18000 contain 8 ball bearings, including 1 CRBB and 1 MagSealed ball bearing.

Drag discs

Sizes 8000 to 14000 contain 7 carbon drag discs and size 18000 9 carbon drag discs.

Handle knob

Models 8000-P and 10000-P with round EVA knob.

Art.-No.	Size	BB MSBB	BB CRBB	BB total	Capacity m/mm	Ratio	Retrieval cm	Drag kg	Weight g
10315-080	8000-H	1	1	8	300/0.33	5.8:1	111	25.0	625
10315-081	8000-P	1	1	8	300/0.33	4.8:1	92	25.0	615
10315-100	10000-H	1	1	8	300/0.37	5.8:1	118	25.0	630
10315-101	10000-P	1	1	8	300/0.37	4.8:1	98	25.0	620
10315-140	14000-XH	1	1	8	300/0.40	6.2:1	134	25.0	635
10315-180	18000-H	1	1	8	300/0.47	5.8:1	131	30.0	850



23 CALDIA SW

SALTWATER SPINNING REEL



AIR ROTOR

MAGSEALED



The new Sea fishing reel with MQ reel body and extra-strong gear!

With the Caldia SW DAIWA offers an extra-strong and tough sea fishing reel for targeting cod, halibut, coalfish and pollack as well as for medium-heavy fishing for amberjack, mahi mahi etc.

The aluminum MQ body allows the application of a considerably larger gear, which displays an extraordinary retrieving power and durability. Due to the special large teeth at the Tough Digigear drive unit the power transmission is improved while the running smoothness and lifespan are markedly elevated. The Magsealed design at the shaft prevents the intrusion of saltwater and particles via the main axis and reduces the threat of corrosion. Together with the carbon fiber drag discs the ATD drag system cares for an even line release under load, a high drag power and a long lifespan. With extra-strong aluminum handle and extra-large T-Shape handle knob.

- MQ® Monocoque aluminum reel body
- MagSealed® body construction
- 6 ball bearings (incl. 1 CRBB®)
- AIR ROTOR®
- TOUGH DIGIGEAR®
- MagSealed® side axis construction
- ATD™ drag system
- Cross Wrap® system
- CNC-machined aluminum spool
- AIR BAIL®
- Machined screw-in aluminum handle
- T-Shape handle knob



Art.-No.	Size	BB CRBB	BB total	Capacity m/mm	Ratio	Retrieval cm	Drag kg	Weight g
10320-405	4000D-CXH	1	6	150/0.37	6.2:1	99	12.0	290
10320-605	6000D-H	1	6	150/0.43	5.7:1	101	12.0	425
10320-805	8000-H	1	6	200/0.40	5.7:1	110	15.0	630
10320-105	10000-H	1	6	200/0.47	5.7:1	121	15.0	645



20 BG MQ

SALTWATER SPINNING REEL

MQ

ATD
AUTOMATIC DRAG SYSTEM

TOUGH DIGIGEAR

HardBodyz
Light & Rigid Metal Construction

Ultra-strong spinning and sea fishing reel with Monocoque body.

With the BG Monocoque reel DAIWA introduces the next generation of the incredibly strong and tough BG reels.

Thanks to the MQ design the drive wheel can be supersized up to 20-40% (depending on the model size) compared to conventional spinning reels. As a result, the power transmission and lifespan are significantly increased. Additionally, also the teeth at the drive wheel are enlarged which leads to a better durability and also prolongs the lifespan. The distortion-proof aluminum body cares for an optimal housing of the gear and ensures permanent smooth running.

Depending on the size the BG MQ reels are the proper choice for medium-heavy spin fishing in fresh water – particularly for heavy lures and permanent application – but are also suited for extreme sea fishing for tuna and GT.

The sizes 6000 and 20000 are the fitting powerhouses for medium-heavy and heavy fishing in Norway for large cods and halibut.



- MQ® Monocoque aluminum reel body
- 6 ball bearings
- TOUGH DIGIGEAR®
- Infinite Anti-Reverse®
- ATD™ drag system
- Carbon drag discs
- Cross Wrap® system
- ABS® aluminum longcast spool
- Twist Buster® II line roller
- CNC-machined aluminum handle
- Hi-Grip handle knob
- From size 6000 - manual bail return

Art.-No.	Size	BB total	Capacity m/mm	Ratio	Retrieval cm	Drag kg	Weight g
10465-250	2500D-H	6	150/0.28	5.7:1	80	10.0	235
10465-300	3000D-XH	6	150/0.33	6.2:1	83	10.0	265
10465-400	4000D-XH	6	150/0.37	6.2:1	99	12.0	285
10465-600	6000D-H	6	150/0.43	5.7:1	101	12.0	430
10465-080	8000-H	6	300/0.33	5.7:1	110	15.0	635
10465-100	10000-H	6	300/0.37	5.7:1	117	15.0	640
10465-020	20000	6	300/0.52	5.3:1	134	20.0	860



BG

SALTWATER SPINNING REEL

AIR ROTOR

HardBodyZ™
Light & Rigid Metal Construction

DIGIGEAR

ATD
AUTOMATIC DRAG SYSTEM

The DAIWA BG reels combine highest strainability and retrieving power with a silky-smooth running and premium design.

The HardBodyZ reel body, made of aluminum, cares for a distortion-proof housing of the Digigear II and optimal power transmission during the fight with the fish.

Especially for the use of braided lines the ABS aluminum spool has been equipped with a central rubber ring, which completely prevents slipping of smooth braided lines under strain.

The reel handle is firmly screwed into the reel body and is housed distortion proof and securely – perfect when heavy strains have to be transmitted at sea fishing.

The BG reels are coated by a special "no paint" surface procedure, which completely eliminates the threat of chipping paint flakes also at heavy usage and at sea fishing. Starting at size 4500 these reels are also perfectly suited for the use at heavy jugging or uncompromising fishing for catfish.



- **HARDBODYZ™** reel body
- **6** ball bearings
- **AIR ROTOR™**
- **DIGIGEAR™ II**
- **Infinite Anti-Reverse®**
- **ATD™** drag system
- **ABS™ II** aluminum spool
- **Twist Buster™ II** line roller
- **Aluminum** handle
- **From size 4500 - manual bail return**

Art.-No.	Size	BB total	Capacity m/mm	Ratio	Retrieval cm	Drag kg	Weight g
10460-250	2500	6	190/0.25	5.6:1	84	4.0	265
10460-300	3000	6	220/0.28	5.6:1	95	6.0	305
10460-350	3500	6	220/0.30	5.7:1	97	6.0	400
10460-400	4000	6	270/0.30	5.7:1	101	6.0	405
10460-450	4500	6	320/0.35	5.7:1	109	10.0	625
10460-500	5000	6	430/0.35	5.7:1	120	10.0	640
10460-650	6500	6	340/0.45	5.3:1	123	15.0	835
10460-800	8000	6	500/0.45	5.3:1	135	15.0	850



Baitcasting Reels

TWS[®]
T-Wing System



DAIWA's T-Wing system solves an age old problem with baitcasting reel levelwind systems.

The „T“ aperture allows line to flow freely through the wide top section on outcast, reducing the normally sharp angles, and friction that slow line flowing through a narrow aperture when exiting the reel.

For retrieve line drops in the narrow, lower channel of the „T-WING“ for even distribution across the spool width.

With ordinary levelwind reels, line coming of the spool ends is forced through the line guide at a sharp angle. The result is casting friction, especially when the line guide is parked on one side of the reel. The T-Wing's wider aperture means reduced angles and less line friction from any position.

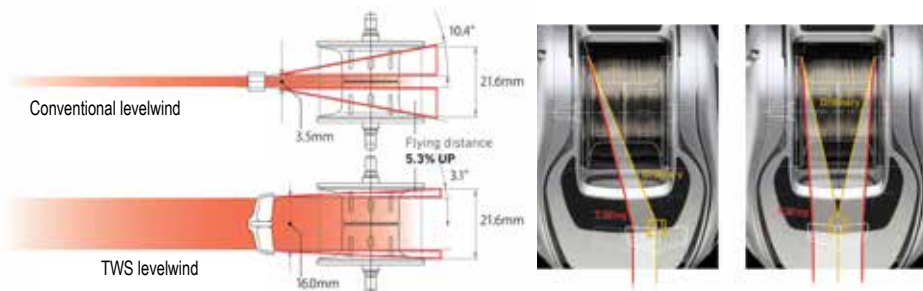

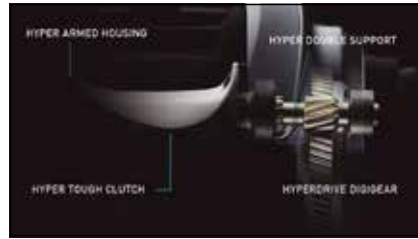

HYPERDRIVE DESIGN

SV BOOST

The SV BOOST drag concept optimizes the casting distances while reducing the threat of backlashes at the same time. The reel setting is pre-configured which eliminates the need to adjust the mechanic drag. This comprises the following technical details:

The extremely lightweight **G1 Duralumin spool** instantly starts without high starting resistance. Smaller lures can be casted in a highly convenient manner.

The **ZERO ADJUSTER** of the mechanic drag is preset in a way that leads to optimal casting distances. (it is recommended not to change this setting)

The **ZERO SHAFT** is made of an extremely short spool axis that causes low friction and instant starting of the spool upon casting. Perfect for smaller lures.

The TWS™ system reduces line friction during the cast

For finetuning the magnetic drag is adjusted according to the used lure weight. This leads to reduced backlashes and an optimized casting performance. In comparison to the SV concept the magnetic drag comes into play during the final phase of the cast.

HYPER DRIVE DESIGN

The HYPER DRIVE DESIGN concept comprises a combination of different manufacturing techniques, which considerably improve the functioning and the lifespan of a baitcasting reel.

HYPER ARMED HOUSING – a distortion-proof metal frame (magnesium, aluminum) that permanently houses the gear unit in a safe way within the reel body.

HYPER DOUBLE SUPPORT – the pinion gear is mounted via each a ball bearing at both sides, leading to a better and more even power transmission from the handle. The surface of the pinion gear is specially treated to prevent electrostatic corrosion.

HYPER TOUGH CLUTCH – the clutch mechanics have been optimized to remain safely in their position also at hard casts.

HYPER DRIVE DIGIGEAR – the gear is further strengthened by larger teeth in the traction wheel but offers nevertheless a very smooth and round functioning due to a special manufacturing procedure.

U.T. Drag



The Ultimate Tournament Drag ensures a perfect interaction between drag control, drag power and super-soft drawing of the line.

DIGIGEAR®



CNC milled digitally developed power gear for highest strains. The precision of the gear teeth is tenfold elevated compared to conventional gears.

MAGFORCE® V/Z



Highly precise casting control system, which prevents tanglings. It controls the centrifugal force of the spool during the first half of the cast, when the threat of tanglings is very high. Afterwards it reduces the resistance automatically and therefore enables longer casts, since less drag pressure is exerted at the spool.

AIRMETAL



The frame and the lateral parts, which bear the gear are made of Air Metal magnesium, which leads to highest stability and distortion-proofness at a low weight.

MAGFORCE 3D®

The Magforce 3D system offers you the choice, how far the magnets are placed from the spool, therefore adjusting the drag strength. By the switch you can adjust the drag in 3 steps:

- MAX BRAKE
- ALL-ROUND
- LONGCAST

→ MAX BRAKE
→ ALL-ROUND
→ LONG CAST

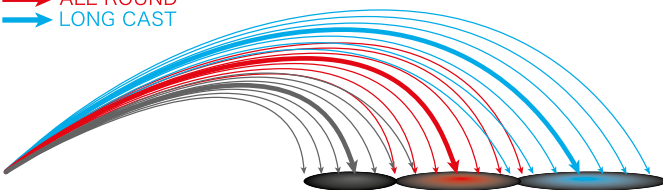

MAX BRAKE

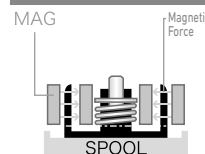

MAX BRAKE – Provides maximum magnetic braking – very helpful when casting into a wind or with big wind-resistant baits.



ALL-ROUND

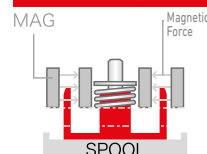

ALL-ROUND – Slightly reducing the inductor cup's movement into the magnetic field provides a reduced braking action at maximum speed. Perfect all-round setting for most applications.



LONGCAST

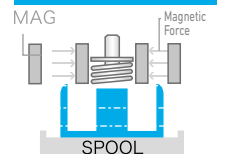

LONGCAST – The magnets move the furthest distance from the inductor, so magnetic braking is minimized for maximum spool speed – great for longer distance.



Ultimate Bass Fishing Gears



**HYPERDRIVE
DESIGN**



24 STEEZ SV TW 100

NEW

BAITCASTING REEL

**HYPERDRIVE
DESIGN**

**HYPER
DIGIGEAR**

24 Steez SV TW – the next generation – with Ultimate Casting Design!

The 24 Steez SV TW has been further improved in many details to support easy handling, especially when casting. The new Ultimate Casting design entirely focuses on comfort and performance when casting. The Ultimate Casting magnetic drag with SV Boost System provides better casting distances and less line trouble when casting thanks to the two-step engagement of the magnetic inductors. The Ultimate Casting Zero Adjuster has been redesigned resulting in basically no modifications to be possible. Thanks to the advances in magnetic drag technology with SV Boost drag, it is nowadays no longer necessary to adjust the mechanical drag on those DAIWA reels. All necessary adjustments can be fully covered by the magnetic dial drag itself. For the Ultimate Casting Line Guide, improvements have been made to the TWS system by slightly changing its size and angle so less line friction is generated and the casting distance is increased. For the extra-light Ultimate Casting spool, the use of G1 Duralumin has reduced the weight and thus improved inertia to further increase casting performance. The lightweight reel body is fully made of magnesium and ensures torsion-resistant support of the Hyper Drive Digigear inside the reel. Thanks to the Hyper Double Support, the shaft is guided almost contact-free on the Pinion Gear by two ball bearings and ensures smooth rotation with improved power transmission when retrieving. With this reel you can simply start and cast as you wish. Perfectly suitable for casting weights from 5g to 40g.



- **HYPER DRIVE Design**
- **Saltwater-resistant construction**
- **12 CRBB® ball bearings**
- **HYPER DIGIGEAR®**
- **UTD® drag system**
- **Star drag with click-system**
- **T-Wing System (TWS™)**
- **SV boost spool**
- **I-Shape handle knob**
- **Left hand version**
- **Made in Japan**



Art.-No.	Size	BB CRBB	BB total	Capacity m/mm	Capacity (2) m/mm	Ratio	Retrieval cm	Drag kg	Weight g
10723-100	100L	12	12	80/0.28	70/0.31	6.7:1	67	6.0	160
10723-101	100HL	12	12	80/0.28	70/0.31	7.8:1	78	6.0	160
10723-102	100XHL	12	12	80/0.28	70/0.31	8.5:1	85	6.0	160



Left hand version



21 STEEZ LIMITED SV TW HL

BAITCASTING REEL

TWS
T-Wing System

SV
BOOST

HYPERDRIVE
DESIGN

MAG SEALED

The high-end baitcasting reel from the DAIWA Japan range. By combining the new Hyper Drive Design concept with the new SV Boost drag concept DAIWA now offers an extremely lightweight but highly durable baitcasting reel, that has been preadjusted in its configuration to allow optimal results without the need for time consuming optimization of the settings.

The Hyper Drive Design concept of the Steez LTD features a combination of a distortion-proof magnesium housing – the Hyper Armed Housing – that safely mounts the gear unit within the reel frame – with a CNC-cut Hyper Drive Digigear. This gear is further strengthened by larger teeth in the traction wheel but offers nevertheless a very smooth and round functioning due to a special manufacturing procedure. The Hyper Tough Clutch lever has been optimized to remain safely in its position also at vigorous casts. Due to the Hyper Double Support the pinion gear is mounted via each a ball bearing at both sides, leading to a better and more even power transmission from the handle. The surface of the pinion gear is specially treated to prevent electrostatic corrosion and to enlarge the lifespan.

The SV Boost drag concept optimizes the casting distances while reducing the threat of backlashes at the same time and contains the following features:

- The extremely lightweight G1 Duralumin spool instantly starts without high starting resistance.
- The Zero Adjuster of the mechanic drag is preset in a way that leads to optimal casting distances. (It is recommended not to change this setting)
- The Zero Shaft is made of an extremely short spool axis that causes low friction and thus is perfect for smaller lures.
- The TWS system reduces line friction during the cast.
- For finetuning the magnetic drag is adjusted according to the used lure weight. This leads to reduced backlashes and an optimized casting performance. In comparison to the SV concept the magnetic drag comes into play during the final phase of the cast.
- Perfect for very small and lightweight lures.

Suited for sea fishing.



- **HYPER DRIVE Design**
- **AIR METAL®** magnesium reel body
- **12 CRBB®** ball bearings
- **HYPER DRIVE DIGIGEAR®**
- **SV Boost drag concept**
- **UTD®** drag system
- **Star drag with click-system**
- **T-Wing System (TWS™)**
- **G1 duralumin SV spool**
- **Soft-touch handle knob**
- **Left hand version**
- **Made in Japan**

Spool diameter: 34mm



Left hand version

Art.-No.	Size	BB CRBB	BB total	Capacity m/mm	Ratio	Retrieval cm	Drag kg	Weight g
10015-100	1000HL	12	12	90/0.33	7.1:1	75	5.0	160



STEEZ A II TW

BAITCASTING REEL

HYPERDRIVE
DESIGN

HYPER
DIGIGEAR

ATD
AUTOMATIC DRAG SYSTEM

TWS
T-Wing System

The extra-strong baitcasting reel from Japan!

With the Steez A II TW, DAIWA introduces a new „Made in Japan“ baitcasting reel that is especially designed for high loads and large lures. This reel can also be applied at saltwater fishing and is applicable for lure weights from 7g on up to 50g. One Magsealed and 9 CRBB ball bearings together with the washable design lead to high durability and a long lifespan also under the harsh conditions of sea fishing.

The Hyperdrive Design represents the combination of a distortion-proof Hyper Armed housing with a Hyperdrive Digigear with extra-large teeth at the driving wheel, leading to optimal retrieving power and extraordinary durability. The special Hyper Tough Clutch is designed to support reliable casting – unintended shifts of the clutch are prevented also during powerful casts. The Hyper Double Support at the Pinion gear features ball bearings at both sides of the spool, leading to a better housing and power transmission from the handle to the drive unit. The Zero Adjuster of the mechanic drag is preset in a way that leads to optimal casting distances (it is recommended NOT to change this setting).

The drag mechanism is waterproof – the entire reel can be cleaned under running lukewarm water without problems.



- HYPER DRIVE Design
- Saltwater-proof construction
- 10 ball bearings (incl. 9 CRBB® & 1 MagSealed® BB)
- HYPER DIGIGEAR® II
- Mag-Z Boost drag concept
- Waterproof ATD™ drag system
- Finely adjustable star drag with click-system
- T-Wing System (TWS™)
- G1 duralumin SV spool
- I-Shape handle knob
- Left hand version
- Made in Japan



Art.-No.	Size	BB MSBB	BB CRBB	BB total	Capacity ml/mm	Ratio	Retrieval cm	Drag kg	Weight g
10720-100	1000L	1	9	10	90/0.33	6.3:1	67	6.0	190
10720-105	1000HL	1	9	10	90/0.33	7.1:1	75	6.0	190



Left hand version



23 SS AIR 8.5 L

BAITCASTING REEL

HYPERDRIVE
DESIGN

UTD[®] Drag
ULTIMATE TOURNAMENT DRAG

TWS
T-Wing System

The 23' SS Air – with Hyperdrive Design.

The SS is especially suited for finesse fishing and for lightweight and ultra-lightweight lures of 3.5 to 12g. The Hyperdrive Design brings together several design elements that considerably improve the running and the lifespan.

The magnesium Hyper Armed Housing cares for a distortion-proof housing of the gear. The Hyperdrive Digigear gets stronger by the larger teeth at the driving wheel and offers silky-smooth running.

The special Hyper Tough Clutch is designed to prevent unintended shifts of the clutch also during powerful casts. The Hyper Double Support at the Pinion gear features ball bearings at both sides of the spool, leading to a better housing and power transmission from the handle to the drive unit.

The G1 Duraluminum Air Spool instantly starts without resistance. Also smaller lures can be casted in a highly convenient manner.

The Zero Adjuster of the mechanic drag is preset in a way that leads to optimal casting distances (it is recommended NOT to change this setting).

The entire reel can be cleaned under running lukewarm water without problems and therefore is perfectly suited for the use at sea fishing.

- HYPER DRIVE Design
- Saltwater-resistant construction
- 8 ball bearings (incl. 4 CRBB[®])
- HYPER DRIVE DIGIGEAR[®]
- UTD[®] drag system
- Finely adjustable star drag with click-system
- T-Wing System (TWS[™])
- G1 duralumin spool
- I-Shape handle knob
- Left hand version
- Made in Japan



Left hand version

Art.-No.	Size	BB CRBB	BB total	Capacity m/mm	Ratio	Retrieval cm	Drag kg	Weight g
10027-085	8.5L	4	8	45/0.235	8.5:1	74	3.5	145



21 ZILLION SV TW PL / XHL

BAITCASTING REEL

TWS
T-Wing System

SV
BOOST

HYPERDRIVE
DESIGN

HardBodyz™
Light & Rigid Metal Construction

Outstanding baitcasting reel from the DAIWA Japan range with SV Boost drag system for optimized casts and Hyper Drive Design concept.

The 21' Zillion SV TW is available in two different versions – the PL model is designed for somewhat larger and heavier lures, which can be retrieved highly conveniently thanks to the low gear ratio. Perfect for applying crankbaits, fishing in greater depths or for sea fishing.

By combining the new Hyper Drive Design concept with the new SV Boost drag concept DAIWA offers a lightweight but nevertheless ultimately tough baitcasting reel, that has been preadjusted in its settings to provide optimal results with a range of lure weights.

The Hyper Drive Design concept stands for a combination of diverse features that optimize the lifespan and handling of the reel.

The SV Boost drag concept optimizes the casting distances while reducing the threat of backlashes at the same time and contains the following features:

- The extremely lightweight G1 Duralumin spool instantly starts without high starting resistance.
- The Zero Adjuster of the mechanic drag is preset in a way that leads to optimal casting distances. (It is recommended not to change this setting)
- The Zero Shaft is made of an extremely short spool axis that causes low friction and thus is perfect for smaller lures.
- The TWS system reduces line friction during the cast.
- For finetuning the magnetic drag is adjusted according to the used lure weight. This leads to reduced backlashes and an optimized casting performance. In comparison to the SV concept the magnetic drag comes into play during the final phase of the cast.
- With drag clicker.



- **HYPER DRIVE** Design
- **HARDBODYZ™** aluminum reel body
- **8 ball bearings** (incl. 4 CRBB[®])
- **HYPER DRIVE DIGIGEAR™**
- **SV Boost drag concept**
- **UTD™** drag system
- **Star drag with click-system**
- **T-Wing System (TWS™)**
- **G1 duralumin SV spool**
- **Soft-touch handle knob**
- **Left hand version**
- **Made in Japan**



Spool diameter: 34mm

Art.-No.	Size	BB CRBB	BB total	Capacity m/mm	Ratio	Retrieval cm	Drag kg	Weight g
10016-100	1000PL	4	8	80/0.36	5.5:1	59	5.0	175
10016-105	1000XHL	4	8	80/0.36	8.5:1	90	5.0	175



Left hand version



TATULA

10 YEARS



TATULA BAITCAST

With the Tatula baitcast reels DAIWA further continues the development of the T-Wing system (TWS). The TWS thereby increases the casting performance compared to conventional baitcast reels about up to 10%.

This is due to the reduced line friction during the cast, since the line exits the reel at a considerable larger angle, which causes less friction. At retrieving, the T-construction is folded into the reel body and the line is guided over the conventional levelwind system. This new generation of the T-Wing system caused huge sensations among the scene at its introduction in the USA. Additionally the spool of the Tatula runs extremely smooth and enables great casting distances.

Also the further equipment is extraordinary for a baitcast reel within this price segment and convinces with many more elucidated details – focusing on the latest Air Rotation system, where the gear is hardly noticeable at retrieving the bait.



TATULA



24 TATULA SV TW 100

NEW

BAITCASTING REEL

**HYPERDRIVE
DESIGN**

UTD[®] Drag
ULTIMATE TOURNAMENT DRAG

TWS
T-Wing System

**SV
BOOST**

24 Tatula SV TW 100 – the latest Tatula model, now with SV Boost system!

The 24 Tatula SV TW 100 now also includes the new SV Boost system. The SV Boost system is a two-stage SV drag system in which the drag power of the magnetic drag is automatically reduced in a 2nd stage of the cast. This increases the casting distance without causing the spool to overrun.

The reel body has been slightly reduced in size compared to the previous model for easy handling in the palm. The Hyper Drive Design with the Hyper Drive Digigear and the Hyper Double Support ensures perfect power transmission and reduces gear noise. The Hyper Armed aluminium frame ensures torque free hold of the inner gear unit inside the body. The Hyper Tough Clutch will not engage even during the most powerful casts. The perfect all-round reel – suitable from approx. 7g to 56g lure weights. Comes with a 90mm long swept handle.

- HYPER DRIVE Design
- Saltwater-resistant construction
- 7 ball bearings
- HYPER DIGIGEAR[®] II
- SV Boost drag concept
- UTD[®] drag system
- T-Wing System (TWS™)
- Super duralumin SV spool
- I-Shape handle knob
- Left hand version



Art.-No.	Size	BB total	Capacity m/mm	Ratio	Retrieval cm	Drag kg	Weight g
10717-100	100L	7	80/0.33	6.3:1	63	5.0	195
10717-101	100HL	7	80/0.33	7.1:1	71	5.0	195
10717-102	100XHL	7	80/0.33	8.1:1	81	5.0	195



Left hand version



TATULA



24 TATULA SV TW 150

NEW

BAITCASTING REEL

**HYPERDRIVE
DESIGN**

UTD[®] Drag
ULTIMATE TOURNAMENT DRAG

TWS
T-Wing System

**SV
BOOST**

24 Tatula SV TW 150 – the power model for big baits with SV Boost braking system!

The 24 Tatula SV TW 150 is particularly suitable for larger lures from approx. 14g to 100g and is therefore the perfect choice for lighter big bait fishing for pike. The reel features the innovative SV Boost System, a two-stage SV drag system that slightly reduces the drag power automatically in the 2nd stage of cast. This increases the casting distance and simultaneously eliminating the risk of an overrunning spool. The Hyper Drive design with the powerful Hyper Drive Digigear and the Hyper Double Support ensures perfect power transmission of the gear and reduces gear noise. The Hyper Armed aluminium body provides a torque free location of the inner gear unit. The Hyper Tough Clutch will not engage even during powerful casts. Comes with 100mm swept handle.

- **HYPER DRIVE Design**
- **Aluminum reel body**
- **Saltwater-resistant construction**
- **7 ball bearings (incl. 2 CRBB[®])**
- **HYPER DIGIGEAR[®]**
- **UTD[®] drag system**
- **T-Wing System (TWS[™])**
- **Ultra super duralumin SV spool**
- **I-Shape handle knob**
- **Left hand version**



 **TATULA** **10 YEARS**



Left hand version

Art.-No.	Size	BB CRBB	BB total	Capacity m/mm	Ratio	Retrieval cm	Drag kg	Weight g
10717-150	150L	2	7	105/0.33	6.3:1	66	5.0	205
10717-151	150HL	2	7	105/0.33	7.3:1	78	5.0	205
10717-152	150XHL	2	7	105/0.33	8.4:1	89	5.0	205



23 TATULA TW 100

BAITCASTING REEL

**HYPERDRIVE
DESIGN**

UTD[®] Drag
ULTIMATE TOURNAMENT DRAG

TWS
T-Wing System

SV CONCEPT

The all-rounder with Hyperdrive Design!

The novel Hyperdrive Design concept is based on three main pillars – the Hyper Armed body that leads to a distortion-proof housing of the gear, the Hyperdrive Digigear that thanks to its large teeth at the driving wheel cares for an enlarged lifespan and high power transmission and the Hyper Tough Clutch that prevents unintended turning of the clutch during casting.

The Zero Adjuster of the mechanic drag is preset in a way that leads to optimal casting distances (it is recommended NOT to change this setting).

The entire reel can be cleaned under running lukewarm water without problems and therefore is perfectly suited for application at sea fishing.

The new Tatula TW 100 is a real all-round reel and is best applied for lure weights from 7g up to 35g.

- **HYPER DRIVE Design**
- **Aluminum reel body**
- **Saltwater-resistant construction**
- **7 ball bearings**
- **HYPER DIGIGEAR[®]**
- **UTD[®] drag system**
- **Magforce[®]-Z magnet drag system**
- **T-Wing System (TWS[™])**
- **Super duralumin SV spool**
- **Aluminum handle**
- **I-Shape handle knob**
- **Left hand version**



Art.-No.	Size	BB total	Capacity m/mm	Ratio	Retrieval cm	Drag kg	Weight g
10714-110	100L	7	100/0.33	6.3:1	67	5.0	195
10714-111	100HL	7	100/0.33	7.1:1	75	5.0	195
10714-112	100XHL	7	100/0.33	8.1:1	86	5.0	195



Left hand version



TATULA SV TW 70

BAITCASTING REEL

HYPERDRIVE
DESIGN

UTD[®] Drag
ULTIMATE TOURNAMENT DRAG

TWS
T-Wing System

SV
CONCEPT

The tool for lightweight lures!

If you are looking for a compact and lightweight reel, that is fully capable of handling thin lines and lightweight lure, the Tatula SV TW 70 is the proper choice. By applying the SV concept in combination with the shallow spool the spool starts without high starting resistance, making this reel ideally suited for casting small cranks, Texas Rigs and stickbaits to long distances.

The Hyper Drive Design concept is made of 4 basic elements: The distortion-proof housing, which cares for a safe positioning of the gear; the Hyper Drive Digigear with extra-large gearwheels for optimal power transmission and smooth running; the Hyper Drive clutch system cares for optimal handling and small tolerances as well as the special double mounting of the pinion gears for enhanced power transmission.

- HYPER DRIVE Design
- Aluminum reel body
- Saltwater-resistant construction
- 7 ball bearings
- HYPER DIGIGEAR[®]
- UTD[®] drag system
- T-Wing System (TWS[™])
- SV spool
- Aluminum handle
- I-Shape handle knob
- Left hand version



Left hand version

Art.-No.	Size	BB total	Capacity m/mm	Ratio	Retrieval cm	Drag kg	Weight g
10714-070	70HL	7	80/0.26	7.1:1	66	4.5	185
10714-071	70XHL	7	80/0.26	8.1:1	76	4.5	185



18 TATULA HD LTD HL

HEAVY-DUTY BAITCASTING REEL

MAGFORCE

UTD[®] Drag
ULTIMATE TOURNAMENT DRAG

TWS
T-Wing System

The Tatula HD 200HL LTD has been especially designed for uncompromising application with heavy lures and thick braided lines.

The extra-strong brass gear of this heavy-duty reel also withstands the use of heavy shads of 25-30cm. The Air Rotation gear additionally cares for a silky-smooth running and the TWS system increases the casting distance up to 10%, thanks to the reduced line friction.

With 7 CRBB ball bearings, the Tatula HD LTD is also the proper choice for fishing in brackish water, e.g. the Bodden or the Swedish skerries.



- Aluminum reel body
- 7 CRBB[®] ball bearings
- CNC-machined gear
- UTD[®] drag system
- Star drag with click-system
- Magforce[®] magnet drag system
- T-Wing System (TWS[™])
- Aluminum handle
- Soft-touch handle knob
- Left hand version



Art.-No.	Size	BB CRBB	Capacity m/mm	Ratio	Retrieval cm	Drag kg	Weight g
10710-225	200HL	7	180/0.32	6.3:1	71	6.0	230



Left hand version



TATULA HD HSL

HEAVY-DUTY BAITCASTING REEL

MAGFORCE

UTD[®]drag
ULTIMATE TOURNAMENT DRAG

TWS
T-Wing System

The Tatula HD 200HSL has been also developed as a heavy-duty reel in response to requests for greater line capacity.

The 200SHL has the same body size as the 100 models, but can hold much more line due to the deep spool – ideal for crankbait fishing with thick, braided lines.

The TWS system enhances the casting distances compared to usual baitcast reels up to 10%.

The Air Rotation gear is hardly perceptible during retrieving and ensures an extremely soft running of the spool.

- Aluminum reel body
- 7 ball bearings
- CNC-machined gear
- UTD[®] drag system
- Star drag with click-system
- Magforce[®] magnet drag system
- T-Wing System (TWS™)
- Aluminum handle
- Soft-touch handle knob
- Left hand version



Left hand version

Art.-No.	Size	BB total	Capacity m/mm	Ratio	Retrieval cm	Drag kg	Weight g
10710-220	200HSL	7	180/0.32	7.3:1	82	6.0	230



20 TATULA TWS 300

HEAVY-DUTY BAITCASTING REEL

TWS
T-Wing System

UTD[®] Drag
ULTIMATE TOURNAMENT DRAG

HardBodyz[®]
Light & Rigid Metal Construction

MAGFORCE[®]
Z



With the Tatlula TWS 300 DAIWA for the first time offers a left handed baitcasting reel with size 300, which has particularly been developed for the use of large lures and strong braided lines.

The double stopper design of the Big Bait reel reliably prevents the anti-reverse from turning free at very cold conditions and at extreme strain. The perfect reel for targeting large pikes in springtime in shallow waters with XXL shads using the Shallow-Screw system. Suited for lures up to approx. 140g.

The Tatlula TWS 300HL offers remarkable 13kg drag power! The XSL features a drag power of 11kg.

- HARDBODYZ[®] reel body
- 7 ball bearings (incl. 2 CRBB[®])
- DIGIGEAR[®] II
- Double-Stopper anti-reverse
- UTD[®] drag system
- Star drag with click-system
- Magforce[®]-Z magnet drag system
- T-Wing System (TWS[™])
- Aluminum handle
- Soft-touch handle knob
- Left hand version



TATULA

Art.-No.	Size	BB CRBB	BB total	Capacity m/mm	Ratio	Retrieval cm	Drag kg	Weight g
10711-304	300XSL	2	7	200/0.34	8.1:1	109	11.0	325
10711-305	300HL	2	7	200/0.34	6.3:1	85	13.0	325



Left hand version



TANACOM 500

ELECTRIC MULTIPLIER REEL



This strong electric multiplier reel with a 12V engine provides convenient assistance at deep sea fishing for ling, redfish and cusk, when heavy rigs have to be retrieved from great depths.

The premium engine is reliably working even under high strain and offers enough power reserves to lift also big fishes up to the surface. With good reason DAIWA's electric reels are well-known as reliable and almost indestructible helpers under extreme conditions since many years. The retrieving speed is approximately 130m/min.

The Tanacom 500 can be operated by hand or via engine. A power pack with 12V/10Ah approximately lasts for one fishing day.



- Electronic line counter (in meter)
- One-piece aluminum body
- Washable construction
- 3 ball bearings
- Waterproof UTD® drag system
- Finely adjustable star drag
- Aluminum spool
- Large soft-touch handle knob
- Right hand version
- Made in Japan

Further fittings:

- Equipped with Power Lever

Delivery includes:

- Electric cable



Line capacity braided lines: 40lb-470m, 50lb-350m, 60lb-300m

Line capacity monofilament lines: 0.37mm-420m, 0.50mm-230m, 0.55mm-190m



Right hand version

Art.-No.	Size	BB total	Capacity m/mm	Ratio	Retrieval cm	Drag kg	Weight g
10806-505	500	3	420/0.37	2.8:1	46	10.0	750



TANACOM 750

ELECTRIC MULTIPLIER REEL



The Tanacom 750 offers an extreme line capacity and a very robust engine, which reliably pulls your rig to the surface also from great depths. Thus, the Tanacom 750 offers reliable DAIWA quality. With good reason DAIWA's electric reels are well-known as reliable and almost indestructible helpers under extreme conditions since many years. The Tanacom 750 can be operated by hand or via engine. A power pack with 12/10Ah approximately lasts for one fishing day.

- Electronic line counter (in meter)
- One-piece aluminum body
- Washable construction
- 4 ball bearings
- Waterproof UTD® drag system
- Finely adjustable star drag
- Aluminum spool
- Large soft-touch handle knob
- Right hand version
- Made in Japan

Further fittings:

- Equipped with Power Lever

Delivery includes:

- Electric cable

Line capacity braided line: 60lb-750m
Line capacity monofilament line: 0.41mm-700m



Art.-No.	Size	BB total	Capacity m/mm	Ratio	Retrieval cm	Drag kg	Weight g
10806-755	750	4	700/0.41	2.3:1	42	20.0	1260



Right hand version



Tanacom



TANACOM 800 / 1200

ELECTRIC MULTIPLIER REEL



The power multiplier reels!

The Tanacom 800 / 1200 offer up to 9 languages for menu navigation (DE, EN, IT, ES, FR, JP, KR, CN) and offer large engine power and easy handling. The special anti-reflection display allows convenient use also when wearing polarized glasses.

- Electronic line counter (in meter)
- One-piece aluminum body
- 4 ball bearings
- Finely adjustable star drag
- Aluminum spool
- Round aluminum handle knob
- Right hand version

Further fittings:

- Equipped with Power Lever

Delivery includes:

- Electric cable

Tanacom 800

Line capacity braided lines: 0.35mm-800m, 0.42mm-600m, 0.51mm-500m

Line capacity monofilament lines: 0.57mm-500m, 0.66mm-350m

Tanacom 1200

Line capacity braided lines: 0.42mm-1000m, 0.51mm-800m, 0.56mm-600m

Line capacity monofilament lines: 0.57mm-800m, 0.66mm-550m



Right hand version

Art.-No.	Size	BB total	Ratio	Retrieval cm	Drag kg	Weight g
10806-805	800	4	2.1:1	59	25.0	1910
10806-125	1200	4	2.1:1	59	25.0	2040



23 LEOBRITZ 300 JL

ELECTRIC MULTIPLIER REEL

JOG
POWER LEVER



The DAIWA left-hand electric reel!

This power reel is perfectly suited for targeting redfish, cod and ling in Norway. Despite the small body the extra-strong Britz engine cares for a higher retrieving power than at the Tanacom 500 models. The small body and the low weight of only 540g allow a convenient handling of this reels. The JOG power lever allows line retrieving without the need of getting your hand off the reel.

The ATD drag with carbon fiber discs release the line without high starting resistance and due to its 13kg drag power offers large reserves – perfect when thin braided lines are used to quickly reach depths larger than 200m. The retrieving speed is about 190m/min.

The special anti-reflection display has been especially developed to allow convenient use also when wearing polarized glasses. With English menu navigation.

- Digital depth counter
- Saltwater-proof construction
- 12 ball bearings
- Star drag
- Round EVA handle knob
- Left hand version
- Made in Japan



Delivery includes:

- Electric cable

Line capacity braided lines: 0.20mm-700m, 0.24mm-400m, 0.28mm-300m

Line capacity monofilament lines: 0.37mm-280m, 0.40mm-200m

Art.-No.	Size	BB total	Ratio	Retrieval cm	Drag kg	Weight g
10806-300	300	12	5.1:1	70	13.0	540



Left hand version



Tanacom

TANACOM S 500 J

NEW

ELECTRIC MULTIPLIER REEL

ATD
AUTOMATIC DRAG SYSTEM

JOG
POWER LEVER



Powering the depth!

This Tanacom S 500 J reel is specially designed to handle deep sea fishing in Norway. The newly developed digital dot liquid panel even provides perfect sight with polarized glasses and for any light irradiation. The new and powerful Magmight motor and offers considerably increased winding power compared to previous constructions. Thanks to the Jog power lever, this reel can be fully operated one-handed. The synchronised level wind constantly provides perfect entrance angle of your line onto the spool. Winding speed: abt. 135m/min. The reel can be operated both, manually or electronically.

- Digital display (in meter)
- Washable construction
- 8 ball bearings (incl. 1 CRBB®)
- ATD™ drag system
- Finely adjustable star drag
- Aluminum spool
- Power handle knob
- Right hand version
- Made in Japan

Further fittings:

- Equipped with Jog Power Lever

Delivery includes:

- Electric cable

Available menu language: English, Japanese, Korean, Chinese.
Line capacity braid: 0.28mm – ca. 500m



Right hand version

Art.-No.	Size	BB CRBB	BB total	Ratio	Retrieval cm	Drag kg	Weight g
10807-500	500	1	8	3.58:1	55	15.0	800



SALTIGA
MADE IN FIELD

24 SALTIGA L

NEW

MULTIPLIER REEL

**HYPERDRIVE
DESIGN**

ATD
AUTOMATIC DRAG SYSTEM

The DAIWA left hand conventional reel for Norway and tropical areas!

The Saltiga 15L is offering latest DAIWA technologies for conventional reels. The aim for development was to provide easy operation by improving the balance, lightness and durability. The body features a special „thumb holding frame“ design to keep the reel in perfect balance. The Hyper Driver Design concept ensures incredible winding power and durability. The machined Hyper Drive Digigear improves power transmission thank to the bigger gear teeth. The Hyper Armed Housing made by aluminium holds the gearing torsion resistant inside the body and the Hyper Tough Clutch always remains in position even on hard casts. The Hyper Double Support provides two ball bearings on each side of the pinion gear to achieve a perfect power transmission from the handle. To avoid corrosion, a victim anode has been installed inside the body. The waterproof ATD drag provides smooth line release under load and facilitates operation with thin lines. Features a click sound star drag. For winding heavy loads, the handle length can be reduced from 85mm to 75mm. The perfect reel for light Jigging and for coalfish, cod and halibut in Norway.

- **HYPER DRIVE Design**
- **Saltwater-resistant construction**
- **8 ball bearings (incl. 7 CRBB® & 1 MagSealed® BB)**
- **HYPER DRIVE DIGIGEAR®**
- **ATD™ drag system**
- **Left hand version**
- **Made in Japan**



Art.-No.	Size	BB MSBB	BB CRBB	BB total	Ratio	Retrieval cm	Drag kg	Weight g
10808-015	15	1	7	8	6.3:1	103	10.0	485



Left hand version



SEALINE ISHIDAI H

LINE COUNTER MULTIPLIER REEL

Classic multiplier reel with digital depth counter and strong power gear.

This reel shows its whole power especially during tough fights with halibut and coalfish in Norway – due to its digital depth counter, you can present the lure with the optimal distance to the ground - an invaluable benefit when coalfish predate in the middle water and you need to provide your lure constantly at the same depth!

Thanks to its great gear transmission you can retrieve your lure for a check at the surface quickly and effortless – you retrieve 120cm per handle turn!

Due to its special construction, this reel is additionally very lightweight and allows enduring effortless fishing.

The maximum drag power of 13kg offers more than enough power to fight even with strong fish.

- Digital depth counter
- 7 CRBB® ball bearings
- Gear ratio 6.4:1
- Infinite Anti-Reverse®
- Sealed drag system
- Star drag with click-system
- CNC-machined aluminum spool
- Aluminum handle
- Right hand version

Further fittings:

- Equipped with ratch drag



Right hand version

Art.-No.	Size	BB CRBB	Capacity m/mm	Ratio	Retrieval cm	Drag kg	Weight g
10804-640	40H	7	360/0.30	6.4:1	120	13.0	585



TANASENSOR 500

LINE COUNTER MULTIPLIER REEL



Legendary powerhouse for the big ones down below!

For many years the Tanasensor has been called a paragon for reliability and power among Norway anglers. Especially the powerful gear is a real benchmark, which successfully has lifted up many large specimen out of great depths over the years.

The electronic display with depth counter offers great advantage when fishing in medium depth or over difficult ground, because you always know where your lure is located.

The gear offers an enormous power transmission and retrieving power – indestructible under normal fishing conditions!

The Tanasensor 500 is the perfect choice when there is need for power and reliability!

- Digital display (in meter)
- Washable construction
- 1 ball bearing
- ATD™ drag system
- Automatic levelwind
- Round Hard EVA handle knob
- Right hand version



Art.-No.	Size	BB total	Capacity m/mm	Ratio	Retrieval cm	Drag kg	Weight g
10815-501	500	1	380/0.41	4.3:1	74	9,0	520



Right hand version



DAIWA SPARE SPOOLS

FRONT DRAG REELS

Spare Spools for Airtly LT

Art.-No.	Matching with Reel(s) Model(s)	Matching with Reel(s) Art.-No.	Matching with Reel(s) Size	Material Spare Spool
19001-203	23 Airtly LT	10001-203	2000S-P	aluminum
19001-201	23 Airtly LT	10001-201	2000S-H	aluminum
19001-250	23 Airtly LT	10001-250	2500S	aluminum
19001-251	23 Airtly LT	10001-251	PC 2500	aluminum
19001-252	23 Airtly LT	10001-252	PC 2500-H	aluminum
19001-300	23 Airtly LT	10001-300	3000-H	aluminum
19001-351	23 Airtly LT	10001-351	PC 3000	aluminum
19001-400	23 Airtly LT	10001-400	4000-XH	aluminum
19001-500	23 Airtly LT	10001-500	5000D-CXH	aluminum

Spare Spools for Exist LT

Art.-No.	Matching with Reel(s) Model(s)	Matching with Reel(s) Art.-No.	Matching with Reel(s) Size	Material Spare Spool
19102-200	22 Exist LT	10102-200	2000-P	aluminum
19102-251	22 Exist LT	10102-251	PC 2500D-H	aluminum
19102-252	22 Exist LT	10102-252	PC 2500D	aluminum
19102-255	22 Exist LT	10102-255	2500	aluminum
19102-300	22 Exist LT	10102-300	3000D	aluminum
19102-301	22 Exist LT	10102-301	3000-H	aluminum
19102-401	22 Exist LT	10102-401	4000D	aluminum
19102-402	22 Exist LT	10102-402	4000-XH	aluminum
19102-500	22 Exist LT	10102-500	5000D-C	aluminum

Spare Spools for Certate LT

Art.-No.	Matching with Reel(s) Model(s)	Matching with Reel(s) Art.-No.	Matching with Reel(s) Size	Material Spare Spool
19424-200	24 Certate LT	10424-200	FC 2000-P	aluminum
19424-250	24 Certate LT	10424-250	FC 2500	aluminum
19424-251	24 Certate LT	10424-251	2500D	aluminum
19424-252	24 Certate LT	10424-252	2500D-H	aluminum
19424-300	24 Certate LT	10424-300	3000D-C	aluminum
19424-301	24 Certate LT	10424-301	3000D	aluminum
19424-400	24 Certate LT	10424-400	4000D-C	aluminum
19424-401	24 Certate LT	10424-401	4000D-CXH	aluminum
19424-500	24 Certate LT	10424-500	5000D	aluminum

Spare Spools for Freams LT

Art.-No.	Matching with Reel(s) Model(s)	Matching with Reel(s) Art.-No.	Matching with Reel(s) Size	Material Spare Spool
19229-101	21 Freams LT	10229-101	1000D	aluminum
19229-200	21 Freams LT	10229-200	2000S	aluminum
19229-201	21 Freams LT	10229-201	2000D	aluminum
19229-250	21 Freams LT	10229-250	2500	aluminum
19229-251	21 Freams LT	10229-251	2500D	aluminum
19229-252	21 Freams LT	10229-252	2500-XH	aluminum
19229-300	21 Freams LT	10229-300	3000-C	aluminum
19229-301	21 Freams LT	10229-301	3000D-C	aluminum
19229-400	21 Freams LT	10229-400	4000-C	aluminum
19229-500	21 Freams LT	10229-500	5000-C	aluminum

Spare Spools for Crossfire LT

Art.-No.	Matching with Reel(s) Model(s)	Matching with Reel(s) Art.-No.	Matching with Reel(s) Size	Material Spare Spool
19186-200	20 Crossfire LT	10186-200	2000	aluminum
19186-250	20 Crossfire LT	10186-250	2500	aluminum
19186-300	20 Crossfire LT	10186-300	3000	aluminum
19186-400	20 Crossfire LT	10186-400	4000	aluminum

Spare Spools for Fuego LT

Art.-No.	Matching with Reel(s) Model(s)	Matching with Reel(s) Art.-No.	Matching with Reel(s) Size	Material Spare Spool
19333-100	23 Fuego LT	10333-100	1000D	aluminum
19333-201	23 Fuego LT	10333-201	2000S-XH	aluminum
19333-251	23 Fuego LT	10333-251	2500-XH	aluminum
19333-250	23 Fuego LT	10333-250	2500	aluminum
19333-300	23 Fuego LT	10333-300	3000-C	aluminum
19333-301	23 Fuego LT	10333-301	3000-CXH	aluminum
19333-305	23 Fuego LT	10333-305	3000D-C	aluminum
19333-404	23 Fuego LT	10333-404	4000-CP	aluminum
19333-401	23 Fuego LT	10333-401	4000D-XH	aluminum
19333-500	23 Fuego LT	10333-500	5000-C	aluminum
19333-605	23 Fuego LT	10333-605	6000D	aluminum

Spare Spools for Exceler LT

Art.-No.	Matching with Reel(s) Model(s)	Matching with Reel(s) Art.-No.	Matching with Reel(s) Size	Material Spare Spool
19336-100	23 Exceler LT	10336-100	1000D	aluminum
19336-200	23 Exceler LT	10336-200	2000D	aluminum
19336-250	23 Exceler LT	10336-250	2500	aluminum
19336-251	23 Exceler LT	10336-251	2500-XH	aluminum
19336-300	23 Exceler LT	10336-300	3000-C	aluminum
19336-301	23 Exceler LT	10336-301	3000-CXH	aluminum
19336-400	23 Exceler LT	10336-400	4000-C	aluminum
19336-401	23 Exceler LT	10336-401	4000D-C	aluminum
19336-500	23 Exceler LT	10336-500	5000-C	aluminum

Spare Spools for GS LTD

Art.-No.	Matching with Reel(s) Model(s)	Matching with Reel(s) Art.-No.	Matching with Reel(s) Size	Material Spare Spool
19501-305	GS LTD	10501-305	3000	aluminum
19501-405	GS LTD	10501-405	4000	aluminum



FRONT DRAG REELS

Spare Spools for Iprimi LT

Art.-No.	Matching with Reel(s) Model(s)	Matching with Reel(s) Art.-No.	Matching with Reel(s) Size	Material Spare Spool
19180-100	24 Iprimi LT	10180-100	1000S-P	aluminum
19180-200	24 Iprimi LT	10180-200	2000S-P	aluminum

Spare Spools for Legalis LT

Art.-No.	Matching with Reel(s) Model(s)	Matching with Reel(s) Art.-No.	Matching with Reel(s) Size	Material Spare Spool
19435-100	23 Legalis LT	10435-100	1000D	aluminum
19435-200	23 Legalis LT	10435-200	2000D	aluminum
19435-205	23 Legalis LT	10435-205	2000S-XH	aluminum
19435-251	23 Legalis LT	10435-251	2500	aluminum
19435-250	23 Legalis LT	10435-250	2500D	aluminum
19435-300	23 Legalis LT	10435-300	3000-C	aluminum
19435-305	23 Legalis LT	10435-305	3000-CXH	aluminum
19435-400	23 Legalis LT	10435-400	4000-C	aluminum
19435-500	23 Legalis LT	10435-500	5000-C	aluminum

Spare Spools for Lexa LT

Art.-No.	Matching with Reel(s) Model(s)	Matching with Reel(s) Art.-No.	Matching with Reel(s) Size	Material Spare Spool
19228-250	23 Lexa LT	10228-250	2500	aluminum
19228-251	23 Lexa LT	10228-251	2500S	aluminum
19228-300	23 Lexa LT	10228-300	3000	aluminum
19228-301	23 Lexa LT	10228-301	3000S-C	aluminum
19228-302	23 Lexa LT	10228-302	3000S-CXH	aluminum
19228-305	23 Lexa LT	10228-305	3000-XH	aluminum
19228-400	23 Lexa LT	10228-400	4000-C	aluminum
19228-405	23 Lexa LT	10228-405	4000-CXH	aluminum
19228-500	23 Lexa LT	10228-500	5000-C	aluminum

Spare Spools for Luvias LT

Art.-No.	Matching with Reel(s) Model(s)	Matching with Reel(s) Art.-No.	Matching with Reel(s) Size	Material Spare Spool
19214-100	24 Luvias LT	10214-100	1000D	aluminum
19214-200	24 Luvias LT	10214-200	2000D	aluminum
19214-250	24 Luvias LT	10214-250	2500S	aluminum
19214-251	24 Luvias LT	10214-251	PC 2500	aluminum
19214-252	24 Luvias LT	10214-252	PC 2500D	aluminum
19214-301	24 Luvias LT	10214-301	3000D	aluminum
19214-302	24 Luvias LT	10214-302	PC 3000	aluminum
19214-401	24 Luvias LT	10214-401	4000D	aluminum
19214-500	24 Luvias LT	10214-500	5000D-C	aluminum

Spare Spools for Matchman

Art.-No.	Matching with Reel(s) Model(s)	Matching with Reel(s) Art.-No.	Matching with Reel(s) Size	Material Spare Spool
19113-250	23 Matchman	10113-250	2500	aluminum
19113-300	23 Matchman	10113-300	3000	aluminum
19113-400	23 Matchman	10113-400	4000	aluminum

Spare Spools for N'Zon Distance 25

Art.-No.	Matching with Reel(s) Model(s)	Matching with Reel(s) Art.-No.	Matching with Reel(s) Size	Material Spare Spool
19133-325	20 N'Zon Distance 25	10133-325	25	aluminum
19133-425	24 N'Zon Plus Distance 25 QD	10133-425	25	aluminum

Spare Spools for N'Zon LT

Art.-No.	Matching with Reel(s) Model(s)	Matching with Reel(s) Art.-No.	Matching with Reel(s) Size	Material Spare Spool
19312-500	20 N'Zon LT	10312-500	5000S-CP	aluminum
19312-600	20 N'Zon LT	10312-600	6000SS-P	aluminum

Spare Spools for N'Zon Plus LT

Art.-No.	Matching with Reel(s) Model(s)	Matching with Reel(s) Art.-No.	Matching with Reel(s) Size	Material Spare Spool
19317-500	24 N'Zon Plus LT	10317-500	5000S-CP	aluminum
19317-600	24 N'Zon Plus LT	10317-600	6000SS-CP	aluminum

Spare Spools for Ninja LT

Art.-No.	Matching with Reel(s) Model(s)	Matching with Reel(s) Art.-No.	Matching with Reel(s) Size	Material Spare Spool
19005-100	23 Ninja LT	10005-100	1000	aluminum
19005-200	23 Ninja LT	10005-200	2000	aluminum
19005-250	23 Ninja LT	10005-250	2500	aluminum
19005-251	23 Ninja LT	10005-251	2500-XH	aluminum
19005-300	23 Ninja LT	10005-300	3000-C	aluminum
19005-351	23 Ninja LT	10005-351	3000-CXH	aluminum
19005-400	23 Ninja LT	10005-400	4000-C	aluminum
19005-500	23 Ninja LT	10005-500	5000-C	aluminum
19005-600	23 Ninja LT	10005-600	6000	aluminum

Spare Spools for Ninja Match & Feeder LT

Art.-No.	Matching with Reel(s) Model(s)	Matching with Reel(s) Art.-No.	Matching with Reel(s) Size	Material Spare Spool
19217-305	23 Ninja Match & Feeder LT	10217-305	3000-C	aluminum
19217-405	23 Ninja Match & Feeder LT	10217-405	4000-C	aluminum
19217-605	23 Ninja Match & Feeder LT	10217-605	6000SS	aluminum

Spare Spools for Prorex MQ LT

Art.-No.	Matching with Reel(s) Model(s)	Matching with Reel(s) Art.-No.	Matching with Reel(s) Size	Material Spare Spool
19610-200	21 Prorex MQ LT	10610-200	2000	aluminum
19610-250	21 Prorex MQ LT	10610-250	2500D	aluminum
19610-255	21 Prorex MQ LT	10610-255	2500-XH	aluminum
19610-300	21 Prorex MQ LT	10610-300	3000D-C	aluminum
19610-305	21 Prorex MQ LT	10610-305	3000-CXH	aluminum
19610-400	21 Prorex MQ LT	10610-400	4000D-C	aluminum



DAIWA SPARE SPOOLS

FRONT DRAG REELS

Spare Spools for Prorex V LT

Art.-No.	Matching with Reel(s) Model(s)	Matching with Reel(s) Art.-No.	Matching with Reel(s) Size	Material Spare Spool
19609-100	22 Prorex V LT	10609-100	1000	aluminum
19609-200	22 Prorex V LT	10609-200	2000	aluminum
19609-250	22 Prorex V LT	10609-250	2500-XH	aluminum
19609-300	22 Prorex V LT	10609-300	3000-C	aluminum
19609-400	22 Prorex V LT	10609-400	4000-C	aluminum
19609-401	22 Prorex V LT	10609-401	4000-CXH	aluminum

Spare Spools for Prorex X LT

Art.-No.	Matching with Reel(s) Model(s)	Matching with Reel(s) Art.-No.	Matching with Reel(s) Size	Material Spare Spool
19611-200	24 Prorex X LT	10611-200	2000	aluminum
19611-250	24 Prorex X LT	10611-250	2500	aluminum
19611-300	24 Prorex X LT	10611-300	3000-C	aluminum
19611-301	24 Prorex X LT	10611-301	3000-CXH	aluminum
19611-400	24 Prorex X LT	10611-400	4000-C	aluminum

Spare Spools for Regal LT

Art.-No.	Matching with Reel(s) Model(s)	Matching with Reel(s) Art.-No.	Matching with Reel(s) Size	Material Spare Spool
19116-107	24 Regal LT	10116-107	1000D-XH	aluminum
19116-207	24 Regal LT	10116-207	2000D-XH	aluminum
19116-257	24 Regal LT	10116-257	2500D-XH	aluminum
19116-307	24 Regal LT	10116-307	3000D-XH	aluminum
19116-407	24 Regal LT	10116-407	4000D-CXH	aluminum
19116-507	24 Regal LT	10116-507	5000D-C	aluminum

Spare Spools for Revros LT

Art.-No.	Matching with Reel(s) Model(s)	Matching with Reel(s) Art.-No.	Matching with Reel(s) Size	Material Spare Spool
19221-102	23 Revros LT	10221-303	3000-CXH	aluminum
19221-202	23 Revros LT	10221-303	3000-CXH	aluminum
19221-252	23 Revros LT	10221-303	3000-CXH	aluminum
19221-302	23 Revros LT	10221-303	3000-CXH	aluminum
19221-303	23 Revros LT	10221-303	3000-CXH	aluminum
19221-402	23 Revros LT	10221-402	4000-C	aluminum
19221-403	23 Revros LT	10221-403	4000-CXH	aluminum
19221-502	23 Revros LT	10221-502	5000-C	aluminum

Spare Spools for Silver Creek MQ LT

Art.-No.	Matching with Reel(s) Model(s)	Matching with Reel(s) Art.-No.	Matching with Reel(s) Size	Material Spare Spool
19307-200	22 Silver Creek MQ LT	10307-200	2000S-XH	aluminum
19307-201	22 Silver Creek MQ LT	10307-201	2500S-XH	aluminum

Spare Spools for Silver Creek X LT

Art.-No.	Matching with Reel(s) Model(s)	Matching with Reel(s) Art.-No.	Matching with Reel(s) Size	Material Spare Spool
19308-200	22 Silver Creek X LT	10308-200	2000S-XH	aluminum
19308-201	22 Silver Creek X LT	10308-201	2500S-XH	aluminum

Spare Spools for Sweepfire EC

Art.-No.	Matching with Reel(s) Model(s)	Matching with Reel(s) Art.-No.	Matching with Reel(s) Size	Material Spare Spool
19118-150	Sweepfire EC	10118-150	1500	nylon
19118-200	Sweepfire EC	10118-200	2000	nylon
19118-250	Sweepfire EC	10118-250	2500	nylon
19118-300	Sweepfire EC	10118-300	3000	nylon
19118-350	Sweepfire EC	10118-350	3500	nylon
19118-400	Sweepfire EC	10118-400	4000	nylon
19118-500	Sweepfire EC	10118-500	5000	nylon

Spare Spools for TD Feeder QD

Art.-No.	Matching with Reel(s) Model(s)	Matching with Reel(s) Art.-No.	Matching with Reel(s) Size	Material Spare Spool
19419-412	18 TD Feeder QD	10419-412	4012	aluminum

Spare Spools for TDM QD

Art.-No.	Matching with Reel(s) Model(s)	Matching with Reel(s) Art.-No.	Matching with Reel(s) Size	Material Spare Spool
19420-312	19 TDM QD	10420-312	3012	aluminum
19420-412	19 TDM QD	10420-412	4012	aluminum

Spare Spools for TDR Distance 25 QD

Art.-No.	Matching with Reel(s) Model(s)	Matching with Reel(s) Art.-No.	Matching with Reel(s) Size	Material Spare Spool
19922-026	23 TDR Distance 25 QD	10922-026	25 QD	aluminum

Spare Spools for TDR Match & Feeder QD

Art.-No.	Matching with Reel(s) Model(s)	Matching with Reel(s) Art.-No.	Matching with Reel(s) Size	Material Spare Spool
19516-258	24 TDR Match & Feeder QD	10516-258	2508QD	aluminum
19516-312	24 TDR Match & Feeder QD	10516-312	3012QD	aluminum
19516-313	24 TDR Match & Feeder QD	10516-313	3012QD-DH	aluminum
19516-412	24 TDR Match & Feeder QD	10516-412	4012QD	aluminum

Spare Spools for QC

Art.-No.	Matching with Reel(s) Model(s)	Matching with Reel(s) Art.-No.	Matching with Reel(s) Size	Material Spare Spool
19431-175	QC 750	10431-175	750	aluminum

FRONT DRAG REELS

Spare Spools for QR

Art.-No.	Matching with Reel(s) Model(s)	Matching with Reel(s) Art.-No.	Matching with Reel(s) Size	Material Spare Spool
19431-075	QR 750	10431-075	750	aluminum

Spare Spools for Tournament QD

Art.-No.	Matching with Reel(s) Model(s)	Matching with Reel(s) Art.-No.	Matching with Reel(s) Size	Material Spare Spool
19406-305	20 Tournament QD	10406-305	3010	aluminum
19406-310	20 Tournament QD	10406-310	3010	aluminum
19406-405	20 Tournament QD	10406-405	4010	aluminum

Universal Spools for LT Reels

Art.-No.	Matching with Reel(s) Size	Material Spare Spool
19115-100	1000D	aluminum
19115-200	2000D	aluminum
19115-250	2500D	aluminum
19115-300	3000D	aluminum
19115-400	4000D	aluminum
19115-500	5000D	aluminum
19115-600	6000D	aluminum

BITE'N RUN REELS



Spare Spools for Black Widow BR A

Art.-No.	Matching with Reel(s) Model(s)	Matching with Reel(s) Art.-No.	Matching with Reel(s) Size	Material Spare Spool
19153-350	Black Widow BR A	10153-350	3500	aluminum
19153-400	Black Widow BR A	10153-400	4000	aluminum
19153-450	Black Widow BR A	10153-450	4500	aluminum
19153-500	Black Widow BR A	10153-500	5000	aluminum

Spare Spools for Black Widow BR LT

Art.-No.	Matching with Reel(s) Model(s)	Matching with Reel(s) Art.-No.	Matching with Reel(s) Size	Material Spare Spool
19149-250	19 Black Widow BR LT	10149-250	2500	aluminum
19149-300	19 Black Widow BR LT	10149-300	3000	aluminum
19149-400	19 Black Widow BR LT	10149-400	4000-C	aluminum
19149-500	19 Black Widow BR LT	10149-500	5000-C	aluminum

Spare Spools for Emblem BR

Art.-No.	Matching with Reel(s) Model(s)	Matching with Reel(s) Art.-No.	Matching with Reel(s) Size	Material Spare Spool
19158-100	Emblem BR	10158-100	10000	aluminum
19158-140	Emblem BR	10158-140	14000	aluminum

Spare Spools for Emblem BR 25 A

Art.-No.	Matching with Reel(s) Model(s)	Matching with Reel(s) Art.-No.	Matching with Reel(s) Size	Material Spare Spool
19928-025	Emblem BR 25 A	10928-025	25	aluminum

Spare Spools for Emcast BR A

Art.-No.	Matching with Reel(s) Model(s)	Matching with Reel(s) Art.-No.	Matching with Reel(s) Size	Material Spare Spool
19152-350	Emcast BR A	10152-350	3500	aluminum
19152-400	Emcast BR A	10152-400	4000	aluminum
19152-450	Emcast BR A	10152-450	4500	aluminum
19152-500	Emcast BR A	10152-500	5000	aluminum

Spare Spools for Emcast BR LT

Art.-No.	Matching with Reel(s) Model(s)	Matching with Reel(s) Art.-No.	Matching with Reel(s) Size	Material Spare Spool
19162-250	24 Emcast BR LT	10162-250	2500	aluminum
19162-300	24 Emcast BR LT	10162-300	3000	aluminum
19162-400	24 Emcast BR LT	10162-400	4000-C	aluminum
19162-500	24 Emcast BR LT	10162-500	5000-C	aluminum

Spare Spools for GS BR LT

Art.-No.	Matching with Reel(s) Model(s)	Matching with Reel(s) Art.-No.	Matching with Reel(s) Size	Material Spare Spool
19144-300	20 GS BR LT	10144-300	3000	aluminum
19144-400	20 GS BR LT	10144-400	4000-C	aluminum
19144-500	20 GS BR LT	10144-500	5000-C	aluminum



DAIWA SPARE SPOOLS

BIG PIT REELS

Spare Spools for Basia 45 SCW QD

Art.-No.	Matching with Reel(s) Model(s)	Matching with Reel(s) Art.-No.	Matching with Reel(s) Size	Capacity Nylon m/mm	Material Spare Spool
19121-048	19 Basia 45 SCW QD	10121-048	45-5000C	300/0.35	aluminum
19121-049	19 Basia 45 SCW QD	10121-048	45-5000LD	530/0.35	aluminum

Spare Spools for Basia 45 SLD QD

Art.-No.	Matching with Reel(s) Model(s)	Matching with Reel(s) Art.-No.	Matching with Reel(s) Size	Material Spare Spool
19121-045	17 Basia 45 SLD QD	10121-045	45-5000C	aluminum

Spare Spools for Black Widow 25 A

Art.-No.	Matching with Reel(s) Model(s)	Matching with Reel(s) Art.-No.	Matching with Reel(s) Size	Material Spare Spool
19133-225	Black Widow 25 A	10133-225	25	aluminum

Spare Spools for Black Widow 35 A

Art.-No.	Matching with Reel(s) Model(s)	Matching with Reel(s) Art.-No.	Matching with Reel(s) Size	Material Spare Spool
19155-550	Black Widow 35 A	10155-550	35-5500	aluminum
19155-600	Black Widow 35 A	10155-600	35-5000LD	aluminum

Spare Spools for Crosscast 35 SCW LD QD

Art.-No.	Matching with Reel(s) Model(s)	Matching with Reel(s) Art.-No.	Matching with Reel(s) Size	Material Spare Spool
19128-609	20 Crosscast 35 SCW LD QD	10128-609	35-5000LD	aluminum

Spare Spools for Crosscast 45 SCW QD

Art.-No.	Matching with Reel(s) Model(s)	Matching with Reel(s) Art.-No.	Matching with Reel(s) Size	Material Spare Spool
19252-500	24 Crosscast 45 SCW QD	10252-500	45-5000C	aluminum
19252-501	24 Crosscast 45 SCW QD	10252-501	45-5000LD	aluminum

Spare Spools for Crosscast 45 SCW QD OT

Art.-No.	Matching with Reel(s) Model(s)	Matching with Reel(s) Art.-No.	Matching with Reel(s) Size	Material Spare Spool
19250-505	21 Crosscast 45 SCW QD OT	10250-505	5000C	aluminum
19250-605	21 Crosscast 45 SCW QD OT	10250-605	5000LD	aluminum

Spare Spools for Crosscast Spod 45 SCW QD

Art.-No.	Matching with Reel(s) Model(s)	Matching with Reel(s) Art.-No.	Matching with Reel(s) Size	Material Spare Spool
19128-610	20 Crosscast Spod 45 SCW QD	10128-610	45-5000C	aluminum

Spare Spools for Crosscast Surf 45 SCW QD

Art.-No.	Matching with Reel(s) Model(s)	Matching with Reel(s) Art.-No.	Matching with Reel(s) Size	Material Spare Spool
19255-500	24 Crosscast Surf 45 SCW QD	10255-500	45-5000C	aluminum

Spare Spools for Emblem 35 SCW LD QD

Art.-No.	Matching with Reel(s) Model(s)	Matching with Reel(s) Art.-No.	Matching with Reel(s) Size	Material Spare Spool
19158-635	23 Emblem 35 SCW QD	10158-635	35-5000C	aluminum
19158-635D	23 Emblem 35 SCW QD	10158-635	35-5000C	aluminum

Spare Spools for Emblem 45 SCW QD (OT)

Art.-No.	Matching with Reel(s) Model(s)	Matching with Reel(s) Art.-No.	Matching with Reel(s) Size	Material Spare Spool
19158-649	23 Emblem 45 SCW QD-OT	10158-649	45-5000C	aluminum
19158-649D	23 Emblem 45 SCW QD-OT	10158-649	45-5000C	aluminum
19158-800	23 Emblem 45 SCW QD	10158-800	45-5000C	aluminum
19158-800D	23 Emblem 45 SCW QD	10158-800	45-5000C	aluminum

Spare Spools for Emblem 45 SCW QD SD

Art.-No.	Matching with Reel(s) Model(s)	Matching with Reel(s) Art.-No.	Matching with Reel(s) Size	Material Spare Spool
19158-700	21 Emblem 45 SCW QD SD	10158-700	45-5000SD	aluminum
19158-700SD	21 Emblem 45 SCW QD SD	10158-700	45-5000SD	aluminum / shallow

Spare Spools for Emblem Spod 35 SCW QD

Art.-No.	Matching with Reel(s) Model(s)	Matching with Reel(s) Art.-No.	Matching with Reel(s) Size	Material Spare Spool
19158-606	18 Emblem Spod 35 SCW QD	10158-606	35-5000C	aluminum

Spare Spools for Emblem Surf 45 SCW QD

Art.-No.	Matching with Reel(s) Model(s)	Matching with Reel(s) Art.-No.	Matching with Reel(s) Size	Material Spare Spool
19711-450	23 Emblem Surf 45 SCW QD	10711-450	45-5000C	aluminum
19711-450D	23 Emblem Surf 45 SCW QD	10711-450	45-5000C	aluminum

Spare Spools for Superspod 45 SCW QD-OT

Art.-No.	Matching with Reel(s) Model(s)	Matching with Reel(s) Art.-No.	Matching with Reel(s) Size	Material Spare Spool
19158-505	23 Superspod 45 SCW QD-OT	10158-505	45-5000C	aluminum

Spare Spools for Tournament Basia 45 SCW QD

Art.-No.	Matching with Reel(s) Model(s)	Matching with Reel(s) Art.-No.	Matching with Reel(s) Size	Material Spare Spool
19121-050	20 Tournament Basia 45 SCW QD	10121-050	45-5000C	aluminum

Spare Spools for Tournament Feeder 25 QD

Art.-No.	Matching with Reel(s) Model(s)	Matching with Reel(s) Art.-No.	Material Spare Spool
19924-025	21 Tournament Feeder 25 QD	10924-025	aluminum

BIG PIT REELS

Spare Spools for Vertice

Art.-No.	Matching with Reel(s) Model(s)	Matching with Reel(s) Art.-No.	Matching with Reel(s) Size	Material Spare Spool
19131-500	24 Vertice	10131-500	35-5000C	aluminum
19131-501	24 Vertice	10131-501	35-5000LD	aluminum

Spare Spools for Whisker 25 QD

Art.-No.	Matching with Reel(s) Model(s)	Matching with Reel(s) Art.-No.	Matching with Reel(s) Size	Material Spare Spool
19930-025	20 Whisker 25 QD	10930-025	25	aluminum

Spare Spools for Whisker 45 SCW QD OT

Art.-No.	Matching with Reel(s) Model(s)	Matching with Reel(s) Art.-No.	Matching with Reel(s) Size	Material Spare Spool
19930-500	22 Whisker 45 SCW QD OT	10930-500	45-5000C	aluminum
19930-500D	22 Whisker 45 SCW QD OT	10930-500	45-5000C	aluminum
19930-500SD	22 Whisker 45 SCW QD OT	10930-500	45-5000C	aluminum

SALTWATER SPINNING REELS

Spare Spools for BG

Art.-No.	Matching with Reel(s) Model(s)	Matching with Reel(s) Art.-No.	Matching with Reel(s) Size	Material Spare Spool
19460-250	BG	10460-250	2500	aluminum
19460-300	BG	10460-300	3000	aluminum
19460-350	BG	10460-350	3500	aluminum
19460-400	BG	10460-400	4000	aluminum
19460-450	BG	10460-450	4500	aluminum
19460-500	BG	10460-500	5000	aluminum
19460-650	BG	10460-650	6500	aluminum
19460-800	BG	10460-800	8000	aluminum

Spare Spools for BG MQ

Art.-No.	Matching with Reel(s) Model(s)	Matching with Reel(s) Art.-No.	Matching with Reel(s) Size	Material Spare Spool
19465-250	20 BG MQ	10465-250	2500D-H	aluminum
19465-300	20 BG MQ	10465-300	3000D-XH	aluminum
19465-400	20 BG MQ	10465-400	4000D-XH	aluminum
19465-600	20 BG MQ	10465-600	6000D-H	aluminum
19465-080	20 BG MQ	10465-080	8000-H	aluminum
19465-100	20 BG MQ	10465-100	10000-H	aluminum
19465-020	20 BG MQ	10465-020	20000	aluminum

Spare Spools for Caldia SW

Art.-No.	Matching with Reel(s) Model(s)	Matching with Reel(s) Art.-No.	Matching with Reel(s) Size	Material Spare Spool
19320-405	23 Caldia SW	10320-405	4000D-CXH	aluminum
19320-605	23 Caldia SW	10320-605	6000D-H	aluminum
19320-805	23 Caldia SW	10320-805	8000-H	aluminum
19320-105	23 Caldia SW	10320-105	10000-H	aluminum

BAITCASTING REELS

Spare Spools for Steez Limited SV TW HL

Art.-No.	Matching with Reel(s) Model(s)	Matching with Reel(s) Art.-No.	Matching with Reel(s) Size	Material Spare Spool
19015-100	21 Steez Limited SV TW HL	10015-100	1000HL	aluminum

Spare Spools for Tatula TWS XSL / HL

Art.-No.	Matching with Reel(s) Model(s)	Matching with Reel(s) Art.-No.	Matching with Reel(s) Size	Material Spare Spool
19711-304	20 Tatula TWS 300	10711-304, 10711-305	300XSL/HL	aluminum

Spare Spools for Zillion SV TW PL / XHL

Art.-No.	Matching with Reel(s) Model(s)	Matching with Reel(s) Art.-No.	Matching with Reel(s) Size	Material Spare Spool
19016-100	21 Zillion SV TW PL / XHL	10016-100	1000PL	aluminum
19016-105	21 Zillion SV TW PL / XHL	10016-105	1000XHL	aluminum

Spare Spools for Certate SW

Art.-No.	Matching with Reel(s) Model(s)	Matching with Reel(s) Art.-No.	Matching with Reel(s) Size	Material Spare Spool
19315-080	21 Certate SW	10315-080	8000-H	aluminum
19315-081	21 Certate SW	10315-081	8000-P	aluminum
19315-100	21 Certate SW	10315-100	10000-H	aluminum
19315-101	21 Certate SW	10315-101	10000-P	aluminum
19315-140	21 Certate SW	10315-140	14000-XH	aluminum
19315-180	21 Certate SW	10315-180	18000-H	aluminum

Art.-No.	Matching with Reel(s) Model(s)	Matching with Reel(s) Art.-No.	Matching with Reel(s) Size	Material Spare Spool
19316-400	24 Certate SW	10316-400	4000-H	aluminum
19316-401	24 Certate SW	10316-401	4000-XH	aluminum
19316-500	24 Certate SW	10316-500	5000-H	aluminum
19316-501	24 Certate SW	10316-501	5000-XH	aluminum
19316-600	24 Certate SW	10316-600	6000-H	aluminum
19316-601	24 Certate SW	10316-601	6000-XH	aluminum

Spare Spools for Saltiga

Art.-No.	Matching with Reel(s) Model(s)	Matching with Reel(s) Art.-No.	Matching with Reel(s) Size	Material Spare Spool
19310-040	23 Saltiga	10310-040	4000-H	aluminum
19310-050	23 Saltiga	10310-050	5000-H	aluminum
19310-060	23 Saltiga	10310-060	6000-H	aluminum
19310-061	23 Saltiga	10310-061	6000-XH	aluminum

Art.-No.	Matching with Reel(s) Model(s)	Matching with Reel(s) Art.-No.	Matching with Reel(s) Size	Material Spare Spool
19310-080	20 Saltiga	10310-080	8000-H	aluminum
19310-100	20 Saltiga	10310-100	10000-H	aluminum
19310-101	20 Saltiga	10310-101	10000-P	aluminum
19310-140	20 Saltiga	10310-140	14000-XH	aluminum
19310-141	20 Saltiga	10310-141	14000-P	aluminum
19310-180	20 Saltiga	10310-180	18000-H	aluminum
19310-200	20 Saltiga	10310-200	20000-H	aluminum





ROD PROGRAM 2025

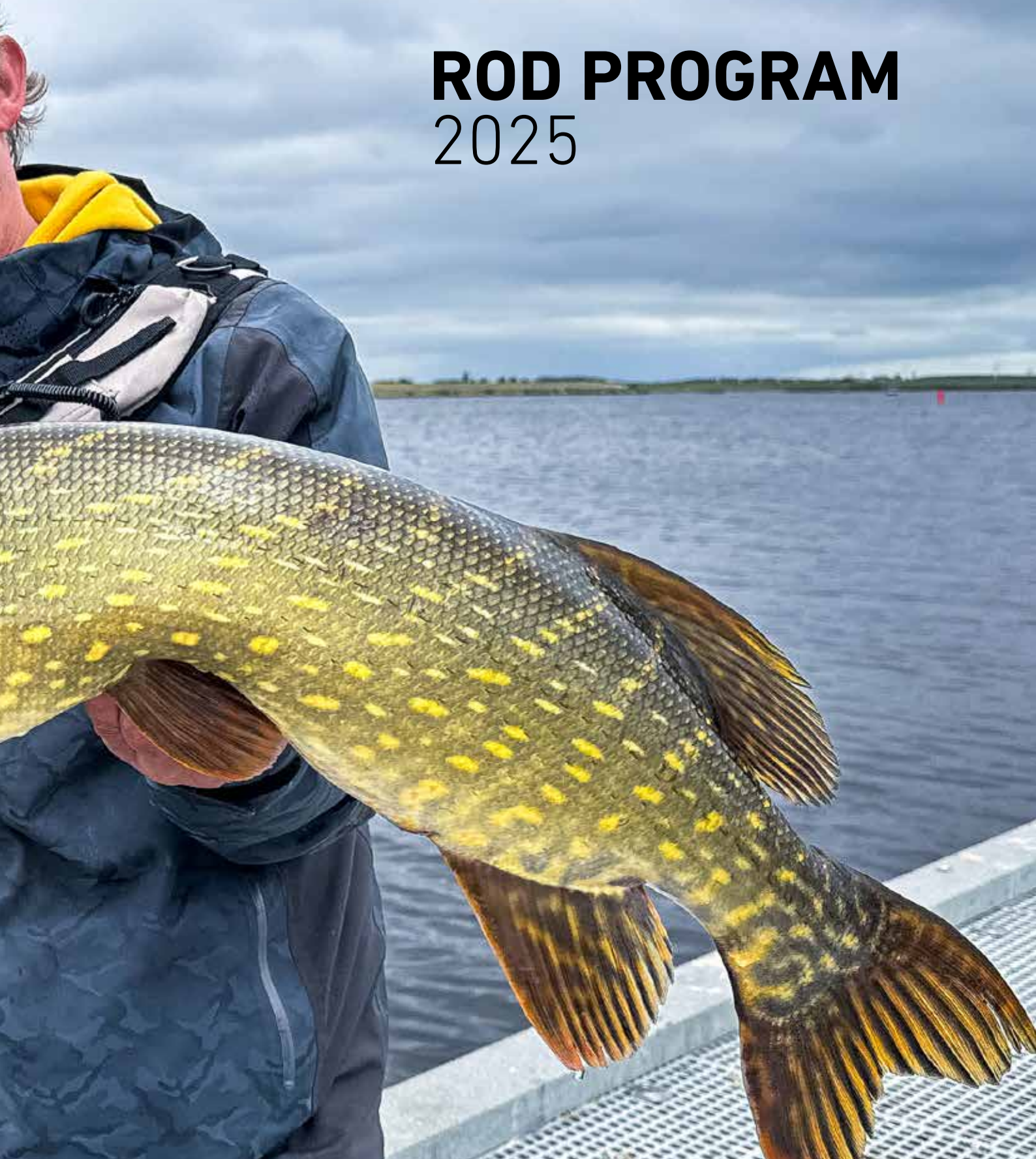



ROD INDEX 2025



SPECIAL ROD INDEX

SEA TROUT SPIN

Art. No.	Series	Length	C.W.	Closed Length	Sections	Weight	No. Guides	Page
11119-280	Morethan AGS ST	2.82m	7-35g	145cm	2	145g	10	132
11119-310	Morethan AGS ST	3.05m	5-35g	157cm	2	170g	11	132
11128-305	Tournament XT Titanium	3.05m	5-35g	157cm	2	170g	10	140
11325-300	Daiba Pro Staff ST	3.00m	8-35g	157cm	2	160g	10	146
11326-320	Daiba Pro Staff ST	3.20m	10-35g	164cm	2	190g	10	146
11326-305	Daiba Pro Staff ST	3.05m	14-42g	157cm	2	185g	10	146
11425-310	Caldia Spin	3.10m	7-35g	160cm	2	190g	9	154
11872-	Wilderness ST				2			158
11124-300	Fuego Predator Spin	3.00m	10-40g	157cm	2	180g	9	162
11666-310	Exceler Traditional ST	3.15m	15-40g	161cm	2	210g	8	164
11665-310	Exceler ST	3.15m	15-40g	162cm	2	185g	8	167
11768-290	Legalis Spin	2.90m	5-35g	152cm	2	165g	9	168
11768-300	Legalis Spin	3.05m	10-40g	159cm	2	175g	9	168
11438-310	Crossfire ST	3.00m	10-30g	156cm	2	195g	8	177
11446-310	Sweepfire ST	3.00m	10-30g	157cm	2	235g	9	179
11253-300	Megaforce Travel	3.00m	10-45g	66cm	5	215g	9	182
11533-312	Seahunter X ST	3.10m	10-40g	160cm	2	185g	9	265

UL/L SPIN/SPOON

Art. No.	Series	Length	C.W.	Closed Length	Sections	Weight	No. Guides	Page
11117-220	Tournament AGS	2.20m	3.5-14g	116cm	2	110g	9	137
11926-195	Airity Hybrid Spin	2.15m	3-10g	111cm	2	105g	9	138
11128-215	Tournament XT Titanium	2.15m	4-18g	111cm	2	105g	9	140
11323-190	Daiba Pro Staff Perch -S	1.95m	3-14g	100cm	2	110g	10	142
11325-195	Daiba Pro Staff Trout A. -S	1.95m	0.5-6g	103cm	2	95g	9	146
11325-210	Daiba Pro Staff Trout A.	2.10m	3-10g	111cm	2	105g	8	146
11508-	Tatula XT UL/L Spin				2			150
11507-	Tatula XT UL Baitcast				2			151
11525-200	Ballistic X	2,00m	3-10g	106cm	2	85g	7	152
11525-210	Ballistic X	2,10m	4-15g	111cm	2	95g	7	152
11425-195	Caldia UL Spin	1.95m	1-6g	101cm	2	100g	8	155
11425-200	Caldia L Spin	2.00m	3-12g	103cm	2	105g	8	155
11427-	Caldia Sensor Spin				2			156
11872-	Wilderness Trout				2		8	158
11873-	Wilderness Solid Spin				2			160
11874-	Wilderness Coregone				2+2			161
11124-200	Fuego Predator Spin	2.00m	3-12g	107cm	2	110g	8	162
11664-	Exceler UL -S				2			167
11768-190	Legalis Spin	1.90m	2-12g	103cm	2	85g	8	169
11768-210	Legalis Spin	2.10m	3-15g	111cm	2	100g	8	169
11204-210	Ninja X UL	2.10m	3-15g	109cm	2	120g	7	170
11204-	Ninja X Solid Tip				2		8	170
11437-	Crossfire UL Spin		2-7g		2			177
11445-	Sweepfire UL Spin		5-10g		2		7	179
11400-	Triforce Target Spoon				2		7	180
11251-	Megaforce Sensitip -S				2			183
11718-	Presso Trout -S		0.5-5g		2		8	184
11718-	Presso Trout		1-6g		2		7	184
11719-	Presso Iprimi -S		0.5-6g		2		8	185
11719-	Presso Iprimi		1-7g		2		7	185
11441-	Silver Creek UL -S		3-14g		2		9	186
11441-	Silver Creek L -S		5-21g		2		9	186
11440-	Silver Creek Spoon		0.5-5/1-6g		2			187
11202-	Ninja X Trout Spoon				2			188
11411-190	Ballistic X Tele Spin	1.90m	4-15g	57cm	6	100g	5	240
11421-190	Sweepfire Tele Spin	1.90m	3-15g	50cm	5	110g	4	244
11213-	Prorex AGS Finesse/Chebu				2			413
11211-225	Prorex AGS Finesse BC	2.05m	3-14g	103cm	2	100g	9	415
11335-235	Prorex XR Chebujig -S	2.35m	3.5-12g	122cm	2	115g	9	417
11335-265	Prorex XR Chebujig -S	2.65m	3.5-12g	137cm	2	130g	10	417
11284-	Prorex X Sensor				2			422
11282-215	Prorex S Finesse Spin	2.15m	3-14g	111cm	2	110g	9	424
11283-205	Prorex S Finesse BC	2.05m	5-14g	106cm	2	120g	9	425

BAITCAST

Art. No.	Series	Length	C.W.	Closed Length	Sections	Weight	No. Guides	Page
11116-210	Morethan Shad Attack BC	2.10m	14-42g	110cm	2	140g	10	135
11118-215	Tournament AGS BC	2.10m	14-42g	110cm	2	115g	9	137
11321-	Daiba Pro Staff BC				2			144
11320-190	Pro Staff Vertical Cat BC	1.90m	180g	135cm	1+1	185g	9	148
11324-215	Pro Staff Baitcast	2.15m	5-18g	111cm	2	125g	9	149
11324-	Pro Staff Baitcast		42g/56g		2		10	149
11507-	Tatula XT BC				2			151
11527-210	Ballistic X BC	2.10m	7-21g	111cm	2	125g	10	153
11527-211	Ballistic X BC	2.10m	8-35g	111cm	2	130g	10	153
11126-	Fuego Predator BC				2			163
11405-215	Triforce BC	2.10m	7-28g	109cm	2	140g	9	180
11214-	Prorex AGS BC				2			415
11304-226	Prorex XR Finesse BC	2.20m	5-14g	114cm	2	120g	10	418
11336-	Prorex XR BC				2			418
11336-	Prorex XR BC				2			419
11285-	Prorex X BC				2			420
11285-	Prorex X BC				2			423
11283-	Prorex S BC				2			425
11283-	Prorex S Crank BC	2.10m		110cm	2		9	425

TRAVEL/MULTIPIECE

Art. No.	Series	Length	C.W.	Closed Length	Sections	Weight	No. Guides	Page
11327-225	Pro Staff Y&B Travel	2.25m	18-76g	62cm	4	145g	8	147
11125-	Fuego Predator Travel				4		8	163
11207-	Ninja X Mobile Spin				3		8	173
11208-	Ninja X-Compact Spin			50cm	9 10		8	173
11253-	Megaforce Travel Spin				4 5			182
11596-	Ninja X Carp 3 sect.				3		6	213
11596-366	Ninja X Carp 4 sect.	12ft	3.00lbs		4		6	213
11596-397	Ninja X Carp 4 sect.	13ft	3.50lbs		4		6	213
11584-369	Black Widow Carp	12ft	3.00lbs		3		6	215
11500-	Saltiga Air Portable				3 4			248
11882-	Grandwave Travel Pilik				5		8	251
11845-226	Sealine X'treme I.Tl. Light	2.25m	100-250g	65cm	4	330g	2	255
11846-	Sealine X'treme I.Tl.				3 4		2	257
11351-	Sealine Travel Pilik	2.40m		66cm	4		7	259
11908-	BG Offshore Travel				4		7	260
11929-	BG Big Game	1.68m		69cm	3		7	262



DAIWA ROD CONSTRUCTION TECHNOLOGIES

Carbon fiber materials

The used carbon fiber material has the greatest impact on the quality of a fishing rod. We at DAIWA permanently seek to enhance the carbon fiber content and to reduce the resin percentage. According to the slogan: more muscles, less fat. This is our way to construct continuously improved rods.

SUPER SVF

Super SVF carbon fiber

The resin content at this exclusive DAIWA material is reduced to a minimum. The manufacturing and processing of Super SVF requires latest machines and is complex as well as expensive. Therefore this material is only used for some of our top products. Rods made of Super SVF carbon are extremely light weight and fast. The blanks instantly resile to the starting position after the cast and therefore allow extremely accurate and long casts.

SVF

SVF carbon fiber

Due to the further reduced resin share at the SVF carbon fiber, the resulting rods are even more sensitive and lighter than HVF carbon fiber rods. Blanks made of SVF carbon fiber are extremely fast and instantly transmit contact with the bottom or fishes and perfectly display the lure action. Torque during and after the casts is almost completely eliminated – contributing to more accurate casts. SVF carbon fiber also is exclusively processed in DAIWA rod factories.

HVF

HVF carbon fiber

This premium high module „High Volume Fiber“ material has been developed by DAIWA and is exclusively processed in our own rod factories. The very slim carbon fibers allow the manufacturing of extra-compact blanks with low resin content. The resulting rods are extremely lightweight, feature a fast action and are better balanced than rods of conventional carbon fiber blanks.



HIGH MODULUS CARBON PLUS

HMC+ carbon fiber

Rod blanks made of „High Modulus Carbon +“ are made of high module carbon fibers with elevated density. As a consequence, HMC+ blanks contain only a reduced resin amount compared to conventional Pre Preg carbon fibers. HMC+ therefore represents a quality level prior to the exclusive HVF carbon fibers. Rods made of this exquisite carbon fiber material are faster, more lightweight and better balanced than rods made of standard materials with high resin amount or composite blanks mixed of carbon and glass fiber.

NANOPLUS

At our Nanoplus technology the resin material first is enriched with a nanoalloy compound and then is used for connecting the single carbon fibers, thus enabling the design of very lightweight and robust blanks.



With the AGS guides (AGS= Air Guide system) DAIWA presents a new era of rod construction technology. The AGS guides have a carbon fiber frame and therefore are considerably more lightweight as for instance



a Fuji Titanium guide, which was, up to now one of the world's most lightweight guides. The reduced weight optimizes the rod action – the rod gets essentially faster and resiles clearly faster. Additionally the use of carbon fiber framed guides reduces vibration of the guides during the cast – more precise casts are the consequence. Whoever takes a rod with AGS guides in the hand will realize immediately the dramatic difference to conventional guides and actions.

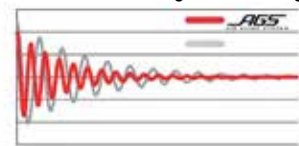

Thanks to AGS the tip resiles faster.



Compared to conventional guides the use of AGS guides results in a weight saving of up to 40%. This implies less strain for the blank and results in a clearly improved resilience.

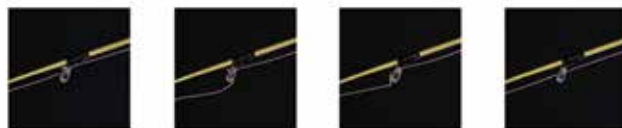

The frame construction reduces the threat of tanglings. Especially at headwind and the use of braided lines the threat of losing lures due to tanglings at the guides is high. AGS guides enable an "escape" of the line at tanglings without knots or loss of the lure.

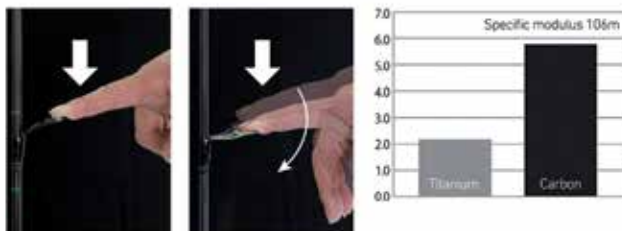

Comparison of the stiffness of carbon and titanium: Carbon features an approximately 3-fold stiffness compared to titanium and therefore is the ideal material for guide construction – the carbon frames of the AGS guide support the sensitivity of the blank like no other material.

3DX[®]

3D CROSS

In contrast to conventional carbon fibers, where the fabric structure always is oriented 2-dimensionally, with 3DX 3D-Cross DAIWA has developed a 3-dimensional carbon fiber material.



The interwoven 3DX carbon fibers are integrated into the blank during manufacturing. This "skeleton" enhances the compression, improves the flexural strength and makes the blank faster.

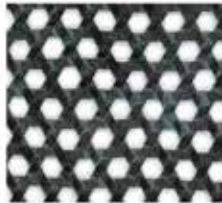

3DX

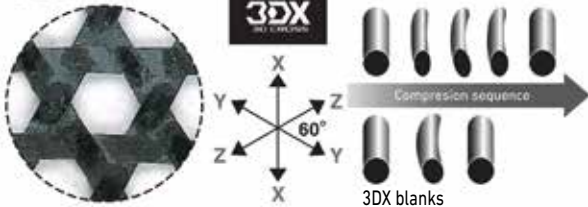

Thanks to the use of 3DX carbon fiber material, the blank compression is considerably improved. The rod features always the same power transmission – regardless the direction of movement. Additionally the rod features obviously reduced torque – more precise casts are the consequence.

The hexagonal pattern is widely distributed in nature and has ever been the basis for substantial technical innovations.



For the V-Joint Alpha spigot joint, exclusive DAIWA BIAS carbon fiber material is combined with the Nanoplus technology. The carbon fiber nano particles within the material increase its stability and reduce its weight. The spigot joint thus can be dimensioned even slimmer.

X45X

X45 FULL SHIELD

With the X45X technology the DAIWA engineers succeeded to apply the proven X45 carbon technology on the complete surface of the rod blank. Thanks to this special location, torsional stiffness has been further improved by 25%. This torque busting technology converts the highest level of rod energy into your cast. This improves not only distance but aids accuracy, power and more control during the fight.

The X45X Full Shield material is easy to recognize on transparent blank varnishes creating an outstanding and beautiful carbon pattern.

X45[®]

Special carbon fiber material for the improvement of the torsion-resistance. Conventional carbon fibers are always layered in a 90° angle – the X45 material features a 45° angle and is combined with 0° and 90° layered carbon fibers. This construction makes the rods stronger and more distortion-proof.

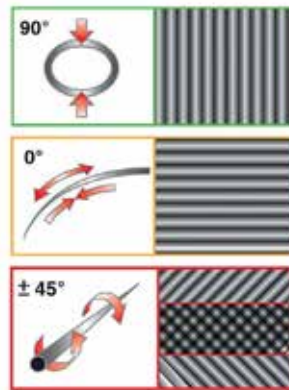

Despite the increased distortion-proofness the flexibility is maintained. This implies that X45 rods are not only stronger and cast more precisely, but also support the angler at the presentation of delicate lures and at ending the fight with the fish safely.

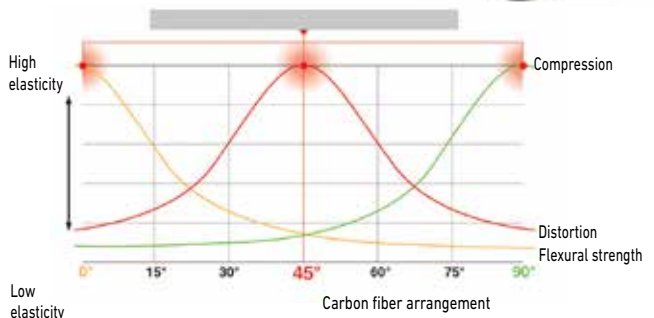

X45 offers the perfect balance of strength, control and elasticity



V-Joint is a special spigot joint, where the spigot and the blank around the spigot are made of a special, exclusively for DAIWA made BIAS carbon fiber material. The carbon fibers follow a 45-degree angle. The consequence is higher strain resistance and an improved bending curve.

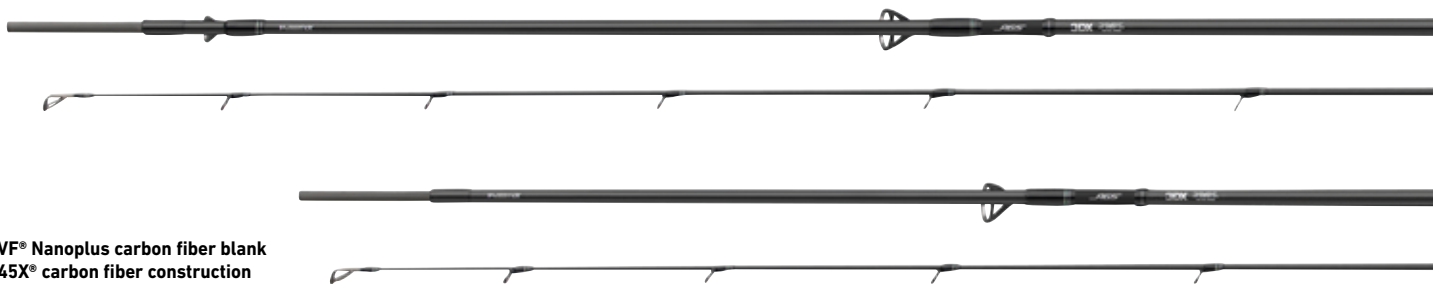

- SVF® Nanoplus carbon fiber blank
- X45X® carbon fiber construction
- 3DX® 3D-Cross carbon fiber surface
- V-Joint® Alpha spigot joint
- Premium Hard EVA grip
- DAIWA® Air Sensor reel seat
- Tubular tip
- AGS® carbon fiber guides
- Fuji® SiC tip guide
- Exclusive transportation holdall

AGS
AIR GUIDE SYSTEM



SVF
nanoplus

3DX
3D CROSS

V-JOINT α
AIRSENSOR

X45X
X45 FULL SHIELD



MORETHAN AGS SEATROUT

NEW

SEA TROUT ROD | ML | M

With the Morethan AGS Sea Trout series, DAIWA clearly demonstrates what exclusive and modern rod building technology can achieve! The application of SVF carbon combined with Nanoplus technology allows to create extremely light and slim blanks that do not torque and cast your lures precisely to the target spot. The Nanoplus technology enables our engineers to design even thinner blanks with increased durability at the same time. The X45X carbon fibre construction improves the compression of the blank and simultaneously adds up more resistance – resulting in longer and more precise casts.

The spigot joint with V-Joint Alpha technology enables the construction of outstanding slim rods with a significantly improved bending curve and increased resilience.

With the Morethan spinning rods you will experience an unbelievable feeling and performance. The extremely light and torsion-resistant AGS guides made of carbon transfer every movement and contact of your lure immediately onto the blank and to your hand. The exclusive Air Sensor reel seat made of a carbon is very light, ergonomically shaped and always holds your reel torque-free.

The shorter "Heavy Hunter" model with 7-35g casting weight is designed for slightly heavier fishing at long range, in heavy winds and deep waters as well as for boats or kayaks.

The 3.10m "Longbow" with a casting weight of 5-25g is slightly more parabolic and has been developed for shallower areas and lighter lures – the ultimate casting machine!

Art.-No.	Length m	Length ft	CW g	Action	Closed L. cm	Sect.	Guides	Weight g
11119-280	2.82	9.3	7-35	extra fast / fast	145	2	10	145
11119-310	3.10	10.2	5-25	extra fast / fast	159	2	11	155



morethan



11119-310

11119-280





MORETHAN SHAD ATTACK

Shad rods from the premium segment!

- SVF® Nanoplus carbon fiber blank
- X45® carbon fiber construction
- V-Joint® Alpha spigot joint
- Cork grip in premium quality
- Fuji® reel seat
- Tubular tip
- Fuji® Titanium SiC K-guides
- Hook keeper
- Exclusive transportation holdall



MORETHAN SHAD ATTACK

SPINNING ROD | M | MH | H

Equipped with the utmost premium components the action of the SVF nanoplus blanks has been precisely matched to the requirements of modern fishing for perch, zander and pike. The Perch and Zander Attack models with 7-32g (Perch) or 14-56g (Zander) casting weight are extremely fast, feature a stiff tip and transmit the attacks of predators perfectly to the handle section. Shads can be presented and accelerated in a highly accurate way. These rods are also perfectly suited for fishing with hardbaits. Twitchbaits and plugs can be casted to long distances and presented in an aggressive way.

The action of the Pike Attack rod with 18-64g casting weight is well suited for classic shad fishing but also does a superb job at steady retrieve fishing with soft plastic lures, medium swimbaits and plugs. At strain this rod displays a soft parabolic at the backbone – perfect when powerful flights have to be absorbed during the fight with big fishes. Thanks to the application of an improved BIAS carbon fiber material the V-Joint Alpha spigot joint connection has been designed even thinner, resulting in a stability increase of up to 10% and a further improved bending curve due to the material saving.

Art.-No.	Length m	CW g	Action	Closed L. cm	Sect.	Guides	Weight g
11116-240	2.40	7-32	ultra fast	125	2	9	145
11116-270	2.70	7-32	ultra fast	141	2	10	165
11116-241	2.40	14-56	ultra fast	125	2	9	155
11116-271	2.70	14-56	ultra fast	141	2	10	160
11116-250	2.55	18-64	extra fast	132	2	9	155

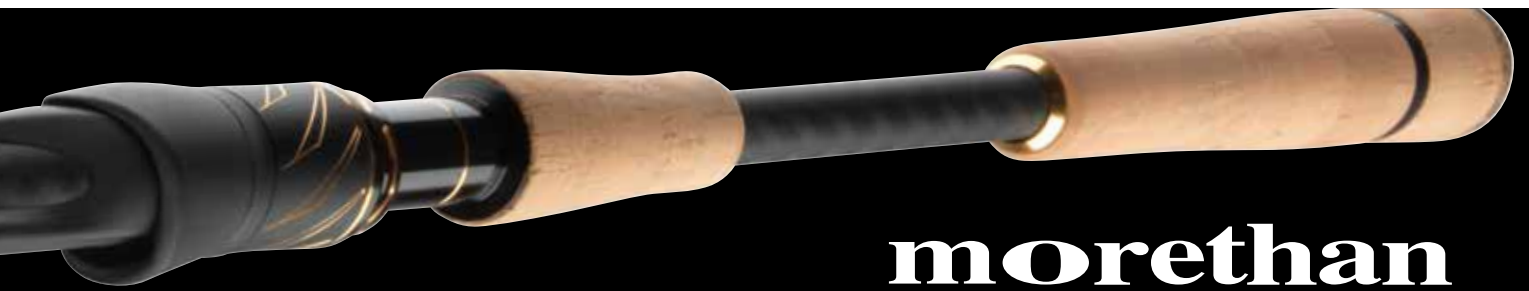

morethan



MORETHAN SHAD ATTACK BAITCAST

BAITCASTING ROD | MH

Beyond the spinning rods the Morethan Shad Attack series offers also a baitcasting rod, which is both applicable for fishing with soft- and hardbaits. With a length of 2.10m this rod can be conveniently applied from the boat and from the shore.

With 14-42g casting weight the Cast Attack accelerates all common shads for perch, zander and pike but also crankbaits and twitchbaits to long distances.

Art.-No.	Length m	CW g	Action	Closed L. cm	Sect.	Guides	Weight g
11116-210	2.10	14-42	ultra fast	110	2	10	140



AGS
AIR GUIDE SYSTEM



- SVF® Nanoplus carbon fiber blank
- X45® carbon fiber construction
- Micro-Pitch taping
- V-Joint® spigot joint
- EVA / carbon fiber grip
- DAIWA® Air Sensor reel seat
- AGS® carbon guides
- Fuji® SiC tip guide
- Wrapped guides
- Removable hook keeper
- Exclusive transportation holdall



TOURNAMENT AGS SPINNING

Due to the use of SVF carbon fiber, X45 construction and the Nanoplus technology, we were able to develop incredibly light and fast blanks for our Tournament AGS rods, which instantly resile to their starting position after the cast! The spigot joint with V-Joint technology enables the design of especially slim rods with enormously improved bending curve and increased resilience regarding the connections between all different parts. The X45 construction improves the compression of the blank and makes the whole rod even more distortion-proof – more precise casts and a reduced risk of fractures are the result!

The Tournament AGS spinning rods care for an outstanding feeling – the extremely light and distortion-proof AGS guides made of carbon fiber send every movement and contact with the lure, ground or fish instantly to the blank.

The patented carbon fiber handle sections with casting weights of 14g, 28g and 42g pass every movement of the blank directly to your lower arm and thus open up a completely new dimension of lure control. The light AGS guides in combination with the carbon fiber handle sections exert enormous influence to the unique action and balance of the blanks – a perfect symbiosis of technologies is the result!

TOURNAMENT AGS SPIN

SPINNING ROD | H | XH

The Tournament AGS rods with 14-42g casting weight are perfect softlure rods for fishing for zander, pike and big perch.

The super-strong and fast blanks allow aggressive jigging of softplastic lures over great distances and submit the "Tock" of a bite clearly and instantaneous. These blanks' actions are also ideally suited for the use of cranks and twitchbaits!

The rods with casting weights of 28-84g are made for heavy spinfishing for pike and zander with big softplastic lures and hardbaits and are equipped with an EVA split handle section. The Hard-EVA within the handle section improves the balance of these powerful spinning rods and guarantees perfect handling and comfort during extreme fights with large specimen!

Art.-No.	Length m	CW g	Action	Closed L. cm	Sect.	Guides	Weight g
11118-210	2.10	14-42	ultra fast	110	2	9	115
11118-240	2.40	14-42	ultra fast	126	2	9	130
11118-270	2.70	14-42	ultra fast	141	2	9	145
11118-245	2.40	28-84	ultra fast	126	2	9	140
11118-275	2.70	28-84	ultra fast	141	2	9	155



TOURNAMENT AGS



11117-240

11117-220

11118-215

11118-245

TOURNAMENT AGS JIGGERSPIN

JIG SPINNING ROD | L | M

The Tournament AGS jig spinning rods are characterized by their particularly distinct tip action. The rods are perfectly made for fishing for zander, perch, trout and chub – the fish can easily soak in small and medium softlures with jigheads up to 12g and you instantaneously feel the bite! The version with a casting weight of 14g is ideally suited as perch, chub and trout rod for fishing with somewhat lighter lures or next to the surface. Fighting fun is guaranteed at any time!

Art.-No.	Length m	CW g	Action	Closed L. cm	Sect.	Guides	Weight g
11117-220	2.20	3.5-14	extra fast	116	2	9	110
11117-210	2.10	7-28	ultra fast	110	2	9	115
11117-240	2.40	7-28	ultra fast	126	2	9	125
11117-270	2.70	7-28	ultra fast	141	2	9	135

TOURNAMENT AGS BAITCAST

BAITCASTING ROD | H

The Tournament AGS Baitcast rod with a casting weight up to 42g has the same features as the spinning version, but is equipped with ergonomic reel seat for baitcasting reels.

Art.-No.	Length m	CW g	Action	Closed L. cm	Sect.	Guides	Weight g
11118-215	2.10	14-42	ultra fast	110	2	9	115



AGS
AIR GUIDE SYSTEM



- SVF® Nanoplus carbon fiber blank
- X45X® carbon fiber construction
- V-Joint® Alpha spigot joint
- Hard EVA / cork grip
- DAIWA® Air Sensor reel seat
- AGS®/Fuji® hybrid guide setting
- Fuji® SiC tip guide
- High-quality transport case with reel spacer

SVF
nanoplus



V-JOINT α

AIRSENSOR

X45X

X45 FULL SHIELD



AIRITY HYBRID SPIN

NEW

SPINNING ROD | L-H

The hybrid concept of the Airity Hybrid series offers a huge variety of technological highlights of DAIWA's exclusive rod building technology and combines unique components with modern design.

Original Fuji SiC K guides are used for the butt guide and the two following guides, while the unique DAIWA AGS carbon guides are installed for all following positions.

This hybrid concept clearly demonstrates the remarkable advantages of AGS guides in practical use – the fast tip of the SVF Nanoplus blank reacts extremely quick due to the weight saving and does not swing. DAIWA AGS guides are approx. 40% lighter than conventional SiC guides with metal frames in the same size. The outstanding hardness and torsional strength of the carbon guides immediately transfer all vibrations and contacts directly onto the blank and into your hand. This results in an incredibly sensitive lure feeling, that will support detection even of the finest bites.

The blanks are also featuring the exclusive X45X technology. This special carbon mat arrangement on the blank surface significantly improves the compression and thus creates an incomparable torsional strength under load. The X45X material also provides an outstanding carbon look on the surface of the blank. All models feature an extremely fast tip action with a stiff backbone – perfect to set the hook at long distances.

The exclusive DAIWA Air Sensor reel seat is made of a composite carbon material, is extremely light and torsion-resistant and feels very comfortable in the palm. The split handle made of high-quality AAA cork and EVA material also visualizes the hybrid concept of this exceptional series. All rods starting from 2.4m length include an inner balance weight to further improve the balance and feeling during usage.

The line-up of the Airity Hybrid series covers the most important methods and is particularly suitable for use with softbaits. The 2.95m model was specially developed for use on large rivers, canals and lakes and enables precise casting to distant spots with lure weights up to 50g. The Airity Hybrid rods are supplied in a high-quality and heavy padded transport holdall that takes up the fully assembled rod.

Art.-No.	Length m	CW g	Action	Closed L. cm	Sect.	Guides	Weight g
11930-210	2.15	3-10	ultra fast	111	2	9	105
11930-225	2.25	4-18	ultra fast	116	2	9	115
11930-240	2.45	7-35	ultra fast	126	2	9	140
11930-241	2.45	14-56	ultra fast	126	2	9	145
11930-270	2.65	7-35	ultra fast	135	2	9	150
11930-271	2.65	14-56	ultra fast	135	2	9	155
11930-255	2.55	18-74	extra fast	131	2	9	165
11930-295	2.95	14-56	extra fast	151	2	10	195



AIRITY

HYBRID



AGS
AIR GUIDE SYSTEM



SVF
nanoplus

V-JOINT α

3DX
3D CROSS

AIRSENSOR

X45



- SVF® Nanoplus carbon fiber blank
- X45® carbon fiber construction
- 3DX® 3D-Cross carbon fiber surface
- V-Joint® Alpha spigot joint
- Premium Hard EVA grip
- DAIWA® Air Sensor reel seat
- Fuji® Titanium SiC K-guides



TOURNAMENT

XT TITANIUM

TOURNAMENT XT TITANIUM SPIN

SPINNING ROD | L-H

High-end DAIWA spinning rods!

The Tournament XT Titanium spinning rods unite best rods manufacturing technologies with premium components.

Due to the extremely low resin content and the resulting low weight the SVF carbon fiber blanks react ultimately fast and allow casts with highest accuracy. With the Nanoplus technology, smallest carbon fiber particles inside the resin lead to an increased weight reduction by elevating the robustness at the same time. For the X45 technology additional carbon fibers are wrapped in a 45° angle, resulting in a considerably stronger and more distortion-proof blank.

The 3DX material at the handle section provides the Tournament XT Titanium Spin with a premium look and reinforces the backbone to a huge extent.

The applied Fuji Titanium SiC guides belong to the most lightweight guides commercially available and feature a markedly decreased weight compared to guides with steel frame.

This weight reduction leads to an extraordinary fast resilience and makes these rods the perfect partner for our most lightweight LT reels.

The original DAIWA Air Sensor carbon composite reel seat is extremely lightweight and distortion-proof and features a pleasant handling.

The handle sections feature premium Hard EVA handles and have been modified to further optimize the rod balance.

The 3.05m model is the proper selection for targeting zander and perch with softlures on far remote spots. Also, perfectly applicable for sea trout fishing at the shoreline with spoons and plugs.

Art.-No.	Length m	CW g	Action	Closed L. cm	Sect.	Guides	Weight g
11128-215	2.15	4-18	ultra fast	111	2	9	105
11128-216	2.15	7-32	ultra fast	111	2	9	120
11128-235	2.35	7-35	ultra fast	120	2	9	130
11128-265	2.65	7-35	ultra fast	135	2	9	145
11128-236	2.35	14-42	ultra fast	120	2	9	130
11128-266	2.65	14-42	ultra fast	135	2	9	150
11128-237	2.35	18-64	ultra fast	120	2	9	135
11128-267	2.65	18-64	ultra fast	135	2	9	155
11128-305	3.05	5-35	extra fast	157	2	10	170



TOURNAMENT

X^TTITANIUM



11128-215



11128-236



11128-265



11128-305





PRO STAFF SPINNING

The DAIWA Pro Staff series has been created in close cooperation with our DAIWA Teamangler, Nils Gabsa, Marten Laciny, Adrian Prus, Sebastian Bischof, Horst Hennings, Tim Jaschke and Marcel Asbroek.

Our experts have spent many hours at the water during the development, testing numerous prototypes until perfect special rods have been constructed! The blank's action, the used components, technologies and constructional details as e.g. length of the handle, have especially been designed for perch/zander, vertical, pelagic and pike/Big Bait experts. To satisfy the needs of our Teamangler, numerous of DAIWA's top technologies have been included.

The HVF Nanoplus carbon fiber material enables the construction of very light, slim, fast and – at the same time – extremely resilient blanks. Due to the addition of nano particles, the already small amount of resin has been further reduced. The blanks got even faster and more lightweight!

The X45 carbon fiber construction leads to an improved compression of the blank thanks to the special positioning of the carbon fibers – the blanks are very distortion-proof, enable more precise casts and can be controlled perfectly during the fight and the lure presentation. Additionally the rods get more resistance against damages. The V-Joint technology stands for an exclusively developed, BIAS carbon fiber layer at the spigot joints, made by DAIWA. This special material makes this usually sensitive part of a rod very robust and improves the bending curve at the same time.

We particularly paid attention to the rod's balance – the construction of the handle section, the selection of premium, very light Fuji Alconite K-guides and the used materials together stand for the perfect feeling of the rods and enable effortless fishing over hours.

- HVF® Nanoplus carbon fiber blank
- X45® carbon fiber construction
- Fuji® Alconite K-guides

HVF
nanoplus

X45

V-JOINT



AIRSENSOR



PRO STAFF PERCH

SPINNING ROD | L | ML

The perch models of the Pro Staff series have been designed for two completely different fishing styles.

The Finesse Perch with a casting weight of 3-14g features a spliced-in solid carbon fiber tip and a powerful backbone, leading to a perfect transmission of soft taps, lure action or bottom structures right to the angler. Extremely short upper handles and the innovative Fuji TVS reel seat with lateral pockets allow an instant contact to the blank. The perfect rod for presenting small lures like creature baits on the Flexi-Jig system, mini plugs and many more!

The model with 5-28g casting weight is equipped with a tubular tip and due to the resulting tip action is the proper choice for aggressive jigging with softplastic lures of all kind, but also does a great job at twitching small and medium-sized hardbaits. Perfect when large perches have to be targeted in deeper waters or at currents.

Art.-No.	Length m	CW g	Action	Closed L. cm	Sect.	Guides	Weight g
11323-190	1.95	3-14	extra fast	100	2	10	110
11323-210	2.10	5-28	extra fast	111	2	9	115

DAIWA | **PRO STAFF**



11322-246

11323-190

11323-210

PRO STAFF ZANDER

SPINNING ROD | HMH | H

The DAIWA Pro Staff Zander rods are perfectly made for both – fishing with soft- and hardbait from the shore or from the boat. Casting performance and contact to the lure are outstanding!
 The rod with a casting weight up to 42g has been made for fishing with medium lures at slow currents or standing respectively shallow waters. The Power Zander model can cast lures up to 70g effortlessly and can be used in strong currents or deeper waters.

Art.-No.	Length m	CW g	Action	Closed L. cm	Sect.	Guides	Weight g
11322-245	2.50	14-42	extra fast	129	2	9	140
11322-246	2.50	18-64	extra fast	129	2	9	145

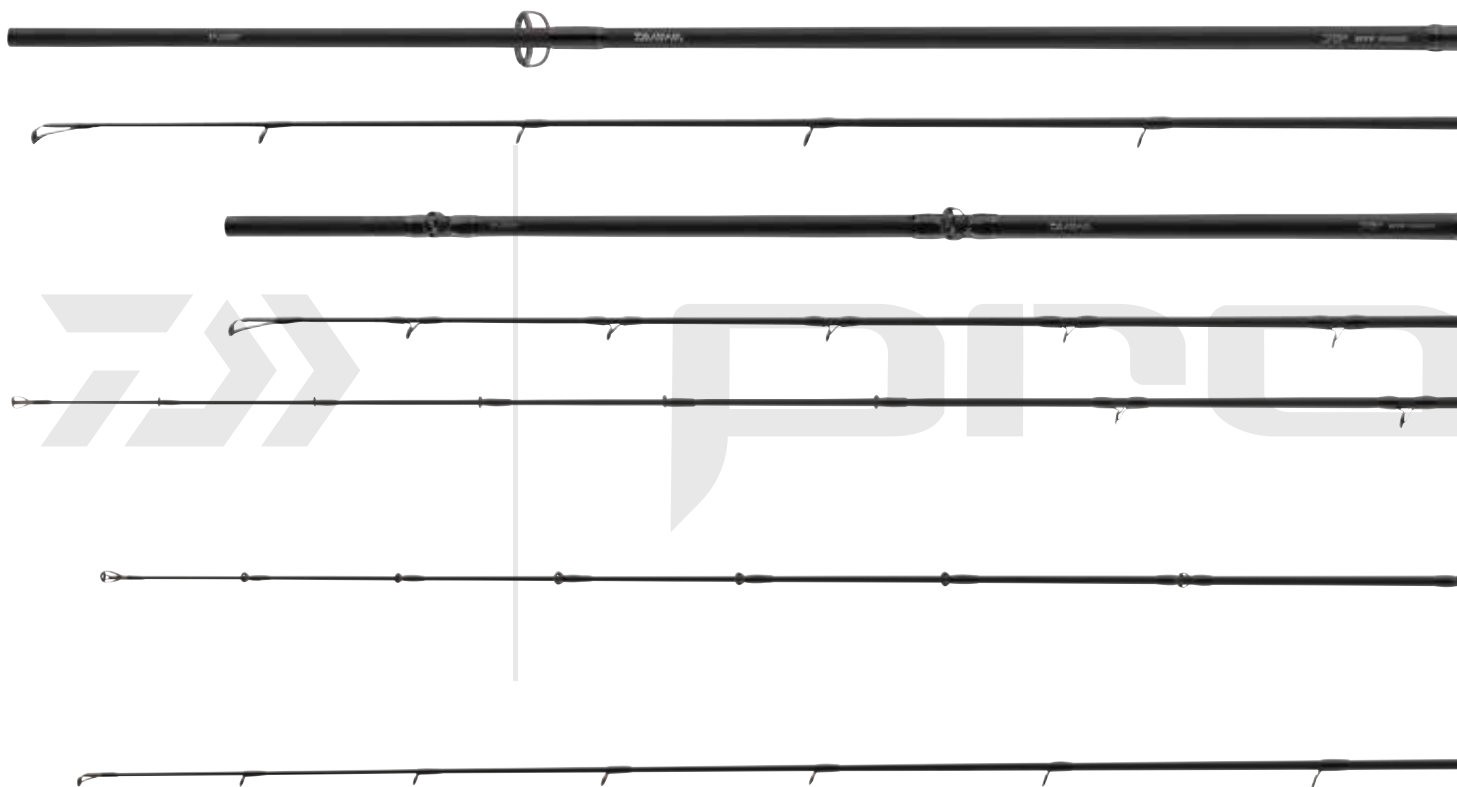

PRO STAFF PELAGIC BAITCAST

BAITCASTING ROD | H

The Pro Staff Pelagic is equipped with a very strong blank and Spiral-Guide-Position. Big and heavy softlures can be fished perfectly and the special guide position prevents tangling of the line at the tip guide at strong wind and waves – pelagic fish can thus be targeted fast and accurately! The 1+1 division of the blank offers extra stability and a perfect bending curve even under extreme strains.

Art.-No.	Length m	CW g	Action	Closed L. cm	Sect.	Guides	Weight g
11321-196	2.00	30-80	extra fast / fast	153	1+1	10	145

PRO STAFF VERTICAL SPIN

SPINNING ROD | MH

The Pro Staff Vertical has been finetuned to the needs of the modern vertical fishing for zander, perch and pike from the boat. The blank's tip action has been adjusted to be able to present even lures with heavy jigheads in strong currents and deep depths seductively. At any times the strong backbone offers enough power to set the hook effectively! This is of biggest importance when catching huge zander or pikes! The 1+1 segmentation of the blank offers a perfect bending curve under load and makes this rod nearly unbreakable under common fishing conditions.

Art.-No.	Length m	CW g	Action	Closed L. cm	Sect.	Guides	Weight g
11324-196	2.10	14-35	extra fast / fast	153	1+1	9	130

PRO STAFF VERTICAL BAITCAST

BAITCASTING ROD | MH

The Pro Staff Vertical Baitcast rod has the same features as the vertical spinning version, but is equipped with Fuji ACS reel seat for baitcasting reels.

Art.-No.	Length m	CW g	Action	Closed L. cm	Sect.	Guides	Weight g
11324-195	2.10	14-35	extra fast / fast	153	1+1	10	145



PRO STAFF BIG BAIT SPIN

SPINNING ROD | H | XH

Big Bait – Big Fish! With our DAIWA Pro Staff Big Bait rods even biggest pikes with heavy softplastic lures or plugs are no problem! Fishing with big lures is naturally very energy-sapping. Thus it's even more important to fish with an ideally balanced and light rod with perfect casting properties! The Big Bait rods, made of HVF carbon fiber with X45 and Nanoplus technology combine exactly those characteristics, which are necessary for an effortless fishing! The classically designed handle section, made of premium cork, pleases your hand and at the same time provides the perfect lever to do long and precise casts. The blank fully loads during the cast and thus supports the angler cast by cast. The rod's tip action and backbone have been constructed in a way to animate dull big lures to action and to buffer headshakes of hooked predators easily.

The Pro Staff Big Bait Spin for the fixed spool reel is equipped with exclusive DAIWA Air Sensor reel seat.

Art.-No.	Length m	CW g	Action	Closed L. cm	Sect.	Guides	Weight g
11320-244	2.50	40-100	extra fast / fast	129	2	9	150
11320-245	2.50	60-140	extra fast / fast	129	2	9	160

PRO STAFF BIG BAIT BAITCAST

BAITCASTING ROD | XXH

The Pro Staff Big Bait Baitcast rods offer the same characteristics as the Big Bait Spinning models and feature an original Fuji ACS reel seat.

Art.-No.	Length m	CW g	Action	Closed L. cm	Sect.	Guides	Weight g
11321-251	2.50	60-140	extra fast / fast	129	2	10	185
11321-250	2.60	80-210	extra fast / fast	133	2	11	220

NEW



PRO STAFF

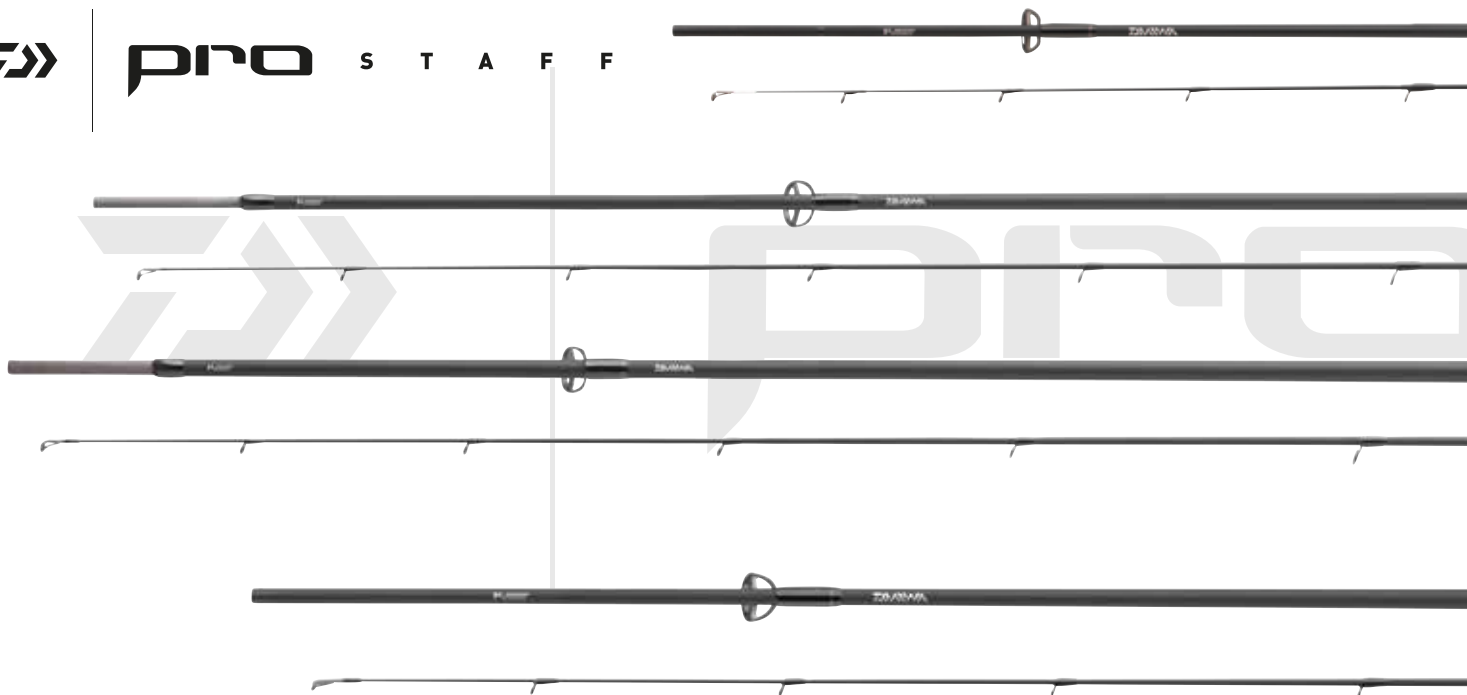

PRO STAFF UL SPIN

SPINNING ROD | UL | L

The two Pro Staff UL rods have been developed together with our Team Angler Tim Jäschke and are perfectly matched with the requirements of modern Trout Area fishing.

The model with a casting weight of 0.5-6g and 1.95m length features a strong backbone and a sensitive spliced-in solid carbon fiber tip – ideal preconditions when very light spoons and plugs have to be presented at far remote spots and total lure control is key.

The model with 2.10m and a casting weight of 3-10g is equipped with a tubular tip and a very fast action. This rod is highly useful for a broad range of trout lures but especially suited for all kind of softlures.

Equipped with a two-sectioned EVA handle and original Fuji TVS reel seat, whose lateral notches allow an instant contact to the blank, therefore providing a magnificent sensation during fishing.

Art.-No.	Length m	CW g	Action	Closed L. cm	Sect.	Guides	Weight g
11325-195	1.95	0.5-6	fast	103	2	9	95
11325-210	2.10	3-10	fast	111	2	8	105

PRO STAFF LD SEA TROUT SPIN

SPINNING ROD | ML | M

The Long Distance Seatrout models have been designed together with our Team Anglers Tim Jäschke and Horst Hennings and are matched to the requirements of experienced sea trout fishermen.

The 3.20 and 3.00m long models from Tim Jäschke are particularly suited for casting smaller lures to long distances. The 3.05m long version of Horst Hennings perfectly loads with somewhat heavier lures and catapults spoons and plugs uncompromisingly to the horizon also under very challenging conditions.

The backbone of these exceptional HVF carbon fiber rods featuring the proven Nanoplus technology has been designed to allow an effective setting of the hook over all kind of distances but to also maintain enough sensitivity to buffer the quick and sudden escapes of large salmonids at the same time.

During the fight with the fish the 3.00m model switches into a parabolic action and therefore is especially suited for the use of very thin lines. By the special arrangement of the carbon fibers, the X45 technology elevates the distortion-proofness of the blanks – the results of this technology can be especially witnessed at very long rods. The long EVA handle offers an ideal lever and supports the rod balance.

Equipped with Fuji Alconite K-guides and exclusive DAIWA Air Sensor reel seat.

Art.-No.	Length m	CW g	Action	Closed L. cm	Sect.	Guides	Weight g
11325-300	3.00	8-35	medium fast	157	2	10	160
11326-320	3.20	10-35	fast	164	2	10	190
11326-305	3.05	14-42	fast	157	2	10	185

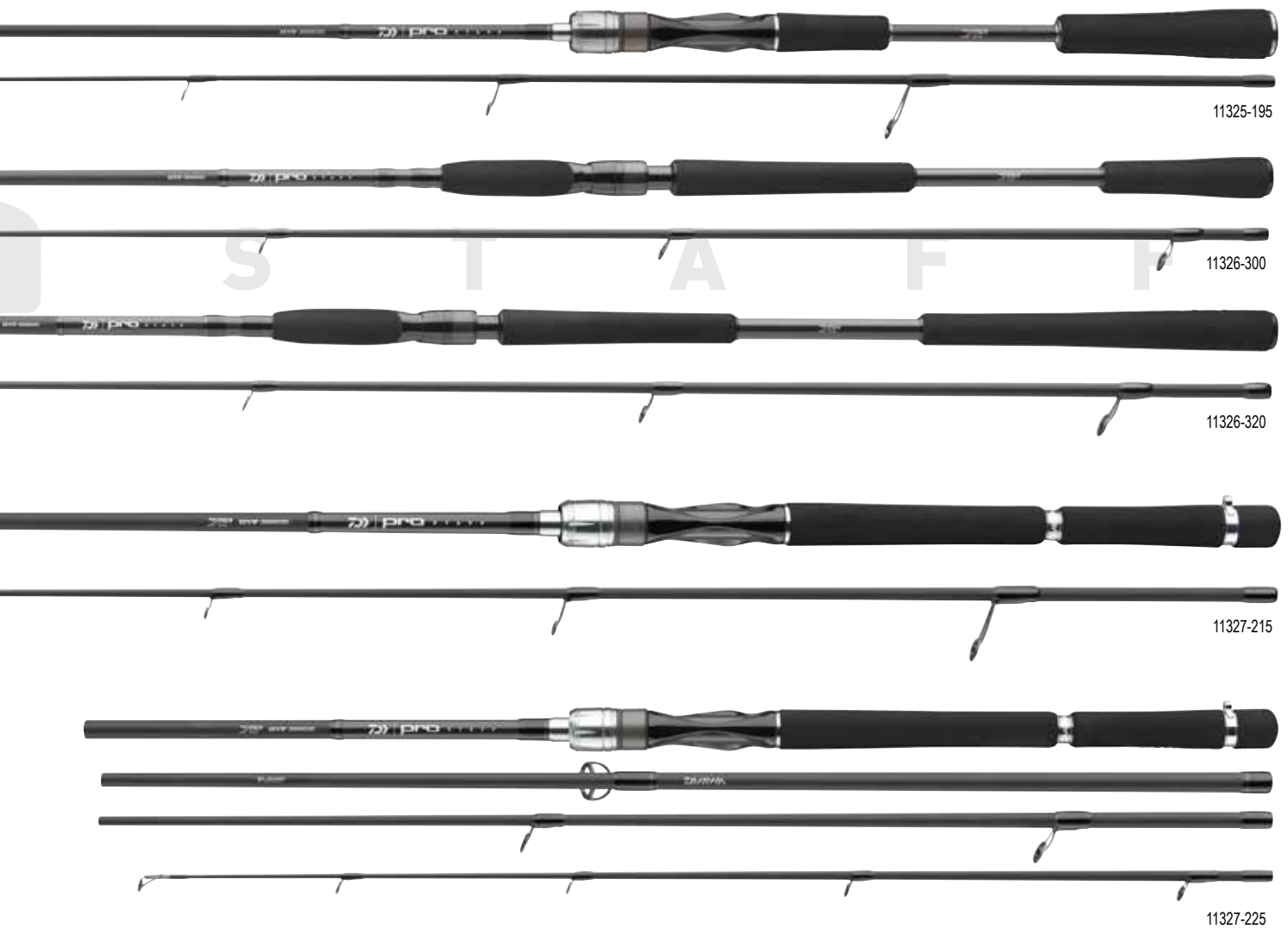

- HVF® Nanoplus carbon fiber blank
- X45® carbon fiber construction
- V-Joint® put-over joint
- Fuji® TVS reel seat
- Fuji® Alconite K-guides



AIRSENSOR

PRO STAFF YAK & BELLY

NEW

SPINNING ROD | ML | M | MH | H

Specialized rods for kayak fishing, belly boats and SUP's.

Boat fishing is enjoying increasing popularity for the last couple of years. DAIWA has now developed a specialized and high-end rod series with exclusive features for fishing on small boats such as kayaks, canoes, belly boats and SUP's. The Yak&Belly rods specially feature extra-short rear handles for easy operation and handling. The lightweight, thin and extremely fast blanks offer perfect sensitivity and great power reserves. The total length of 2.15m or 2.25m has been specially designed for handling at close ranges.

A DAIWA exclusive, freely rotating metal ring with eyelet on the handle offers additional security as the rods can easily be attached by a safety line to your boat if needed. As an additional safety options, a safety line could also be attached to the tapered aluminium ring in the middle of the handle. The line-up of this Pro Staff series covers the most important fishing methods and target fish such as pike, zander and perch. In order to have a such special boat rod on hand when traveling, the four-piece model in 2.25m length offers the same characteristics for fishing with medium to heavy spinning lures in fresh and salt water.

Art.-No.	Length m	CW g	Action	Closed L. cm	Sect.	Guides	Weight g
11327-215	2.15	4-18	extra fast	111	2	9	115
11327-216	2.15	8-35	extra fast	111	2	9	120
11327-217	2.15	14-64	extra fast	111	2	9	135
11327-225	2.25	18-76	extra fast	62	4	8	145



PRO STAFF



PRO STAFF VERTICAL CAT

BAITCASTING ROD | XH

The rods for active catfish hunting were developed together with our team anglers in Poland and Czech Republic.

The Vertical Catfish rod has been exactly matched to the requirements of this successful method from the boat, kajak or belly boat. The 1+1 divided power blank holds large power reserves in the backbone and delivers the sensitivity from the tip, that is needed for successful presentation of the rigs and have fun also at the fight with medium sized specimen. The powerblank offers enough reserves to control also large specimen at every time.

Equipped with Fuji ACS baitcasting reel seat, robust EVA handle and round Packbay buttcap for highest comfort.

Art.-No.	Length m	CW g	Action	Closed L. cm	Sect.	Guides	Weight g
11320-190	1.90	180	extra fast	135	1+1	9	185

PRO STAFF CATFISH SPIN

SPINNING ROD | XXH

The Catspin model from the Pro Staff Catfish range has been developed for active spin fishing from the boat and the shore. Special emphasis has been put on the blank design – the rod allows the application of a broad range of different lures and lure weights. The backbone offers huge reserves to control large catfish even under harsh conditions. The length of 2.60m is especially convenient when fishing from the bank but also allows the application from the boat. The Pro Staff Catspin rod can also be used for fishing for pikes with Big Baits.

Equipped with ergonomic DAIWA Air Sensor reel seat and premium cork handle.

Art.-No.	Length m	CW g	Action	Closed L. cm	Sect.	Guides	Weight g
11320-260	2.60	80-240	fast	134	2	9	190



- HVF® Nanoplus carbon fiber blank
- X45® carbon fiber construction
- V-Joint® put-over joint
- High-quality cork / EVA grip
- DAIWA® Air Sensor reel seat
- Fuji® Alconite K-guides
- Epoxy / rubber butt cap



AIRSENSOR

PRO STAFF BAITCAST

BAITCASTING ROD | L | HMH

The three Pro Staff Baitcast models have been developed together with DAIWA team angler Gunnar Schade and cover two important sectors of modern BC fishing. The rod with 5-18g casting weight is perfect for bringing small twitchbaits and plugs into action but is also strong enough to cope with soft bait fishing. Equipped with single-piece, slim EVA handle and ergonomic DAIWA Air Sensor BC reel seat. The 2.25m model with a casting weight of 14-42g has been extensively tested with all kind of softbaits and medium-sized swimbaits – casting performance and lure control form a perfect alliance! During the testing phase this rod has been also successfully used for fishing with twitchbaits as well as with spinners and chatterbaits. Equipped with two-sectioned EVA handle and ergonomic Fuji ACS reel seat. The Pro Staff Zander BC rod with Art.-No. 11322-247 features an DAIWA exclusive Air Sensor Baitcast reel seat and thanks to the length of 2.40m, it's perfect to cast Softbaits up to 56g to distance and jiggling them aggressively. Also good to be used with bigger hardbaits and with heavy Chutterbaits.

Art.-No.	Length m	CW g	Action	Closed L. cm	Sect.	Guides	Weight g
11324-215	2.15	5-18	extra fast	111	2	9	125
11324-225	2.25	14-42	extra fast	118	2	10	150
11322-247	2.40	14-56	extra fast	126	2	10	160

NEW



TATULA XT SPINNING

With the Tatula XT rods DAIWA offers a specialty rod series that is specifically designed for fishing with very lightweight to medium soft- and hardbaits. Developed and tested with our experts from DAIWA Japan the Tatula XT series even is available globally featuring specific lineups.

Equipped with premium Fuji components and exclusive rod manufacturing technologies like HVF carbon fiber and the X45 design, the Tatula XT rods are hard to surpass regarding price-performance ratio.

- HVF® carbon fiber blank
- X45® carbon fiber construction
- Brading-X handle section
- Premium Hard EVA grip
- Fuji® O-guides



TATULA



TATULA XT SPIN

SPINNING ROD | UL | L | ML | MH

The Spin models with Fuji VSS reel seat are perfectly suited for targeting perch and zander with smallest creature baits, mini plugs and shads. The quick-response blank perfectly loads during the cast and transmits bites, bottom contact and lure action instantly to the angler.

The model with a casting weight of up to 21g allows also the use of heavier jigheads, small chatterbaits or deep running crankbaits.

The rod with art. no. 11508-195 features a spliced-in solid carbon fiber tip that guarantees a simply perfect casting performance even with low casting weights.

Art.-No.	Length m	Length ft	CW g	Action	Closed L. cm	Sect.	Guides	Weight g
11508-190	1.88	6.2	0.45-3.5	extra fast / fast	98	2	8	90
11508-195	1.93	6.4	0.45-3.5	extra fast / fast	100	2	9	90
11508-196	1.93	6.4	0.9-7	extra fast / fast	100	2	8	95
11508-200	2.03	6.8	0.9-7	extra fast / fast	105	2	8	100
11508-201	2.03	6.8	1.8-11	extra fast / fast	105	2	8	105
11508-202	2.03	6.8	3.5-21	extra fast / fast	105	2	8	125



TATULA

10 YEARS



TATULA XT BAITCAST

BAITCASTING ROD | M | MH | H

The baitcast models with casting weights up to 42g are perfectly suited for hunting zanders and pikes with softlures, chatterbaits as well as crankbaits and stickbaits. The blank with power backbone has been designed for application from the boat and in challenging terrain. The short handle unfolds its power especially at waters with heavy vegetation and allows convenient handling during casting and fight. The responsiveness and sensitivity of the fast HVF blank is as extraordinary as the excellent casting and fighting properties! Equipped with exclusive DAIWA baitcasting reel seat.

Art.-No.	Length m	Length ft	CW g	Action	Closed L. cm	Sect.	Guides	Weight g
11507-205	2.08	6.1	5-21	extra fast	108	2	9	120
11507-206	2.08	6.1	7-28	extra fast	108	2	9	130
11507-207	2.08	6.1	11-42	extra fast	108	2	9	135
11507-220	2.21	7.3	7-28	extra fast	115	2	9	135

TATULA XT UL BAITCAST

BAITCASTING ROD | L | ML

The baitcasting rods for ultra-light and finesse lures feature a tubular tip and are especially fast. Thanks to the special arrangement of carbon fibers the X45 technology allows the design of a distortion-proof and robust blank – a huge advantage during the fight. Equipped with exclusive DAIWA baitcasting reel seat.

Art.-No.	Length m	Length ft	CW g	Action	Closed L. cm	Sect.	Guides	Weight g
11507-190	1.96	6.5	1.8-11	extra fast	102	2	10	105
11507-200	1.98	6.6	3.5-14	extra fast	103	2	9	110



BALLISTIC X SPINNING

The well-balanced HVT carbon fiber blank of the Ballistic X Spin is quickly reacting during the fight and casts precisely thanks to the exclusive X45 carbon fiber construction. The BIAS carbon fiber layer is coated via V-Joint technology at the spigot joint and cares for additional stability, reduced weight and a significantly better bending curve.



- HVT® carbon fiber blank
- X45® carbon fiber construction
- V-Joint® put-over joint
- Brading-X handle section
- Premium EVA grip
- Fuji® VSS reel seat
- Seaguide® guides

BALLISTIC X SPIN

SPINNING ROD | M | MH | HMH | H

The instantly responding Ballistic X spinning rods are suitable for different kind of plastic lures depending on the casting weight – you will find the right rod for twitching small to medium cranks or twitchbaits, for jigging heavy plastic lures as well as for fishing with large or heavy plugs.

Equipped with titanium oxide guides from Seaguide and original Fuji reel seat.

Art.-No.	Length m	CW g	Action	Closed L. cm	Sect.	Guides	Weight g
11525-211	2.10	10-40	fast	111	2	7	100
11525-240	2.40	10-40	fast	127	2	8	115
11525-241	2.40	15-50	fast	127	2	8	120
11525-270	2.70	15-50	fast	142	2	9	150
11525-212	2.10	20-60	fast	111	2	7	115
11525-242	2.40	30-70	fast	127	2	8	125
11525-271	2.70	30-70	fast	142	2	9	170

BALLISTIC X UL SPIN

SPINNING ROD | UL | L

The two Ballistic X UL Spin models are perfectly suited for targeting perch, trout and chub with small plugs, shads and spoons.

Art.-No.	Length m	CW g	Action	Closed L. cm	Sect.	Guides	Weight g
11525-200	2.00	3-10	fast	106	2	7	85
11525-210	2.10	4-15	fast	111	2	7	95



BALLISTIC X



BALLISTIC X JIGGERSPIN

JIG SPINNING ROD | ML

The very fast jiggering rods with small guides and tip action are especially made for fishing with softlures. The blank perfectly transmits the bite of zander and perch to the angler. These jiggering models are also well fitting for Dropshot fishing.

Art.-No.	Length m	CW g	Action	Closed L. cm	Sect.	Guides	Weight g
11526-220	2.20	7-28	extra fast / fast	117	2	8	105
11526-240	2.40	7-28	extra fast / fast	127	2	9	110
11526-270	2.70	7-28	extra fast / fast	142	2	9	125

BALLISTIC X BAITCAST

BAITCASTING ROD | ML | M

The two Ballistic baitcasting rods allow the use of various lure types. Due to the stiff blank shallow or deep running cranks can be presented aggressively, while softbaits can be controlled with high precision. Also, spinnerbaits and chatterbaits can be conveniently put into action. The Ballistic X baitcasting rods also are doing a great job at vertical fishing for perch, zander and pike.

Art.-No.	Length m	CW g	Action	Closed L. cm	Sect.	Guides	Weight g
11527-210	2.10	7-21	fast	111	2	10	115
11527-211	2.10	8-35	fast	111	2	10	120



CALDIA SPINNING

The Caldia spinning rods perfectly match with the successful Caldia LT reels.

- HMC+® carbon fiber blank
- Upside-down carbon surface
- Spigot put over joint
- Fuji® Skeleton reel seat
- Seaguide® Zirconia guides



11425-200

CALDIA SPIN

SPINNING ROD | ML-H

The high-modulus HMC+ carbon fiber blanks of the Caldia spinning rods feature a very pleasant handling and are distinguished by their exceptionally fast action – perfect hardbait and softbait rods for fishing for pike, zander, perch and trout!

Lightweight Seaguide guides with slim Zirconia inlays support the fast resilience and have a meaningful impact on the casting performance of these rods. Incredibly long and accurate casts are possible every time! The fast and extra-fast taper blanks transmit contact with the bottom or fish as well as the lure action straight into the handle section. The Fuji Skeleton reel seat without upper handle section allows an instant contact to the blank to perceive every action without delay. The fashionable premium cork handle is very pleasant to operate and cares for a perfect balance even when very lightweight reels are used.

Art.-No.	Length m	CW g	Action	Closed L. cm	Sect.	Guides	Weight g
11425-210	2.10	7-21	extra fast / fast	108	2	8	120
11425-310	3.10	7-35	fast	159	2	9	185
11425-245	2.40	10-40	extra fast / fast	123	2	8	140
11425-246	2.40	15-50	extra fast / fast	123	2	8	145
11425-276	2.70	15-50	extra fast / fast	139	2	8	165
11425-247	2.40	30-70	extra fast / fast	123	2	8	150
11425-277	2.70	30-70	extra fast / fast	139	2	8	175

CALDIA SENSOR JIG SPIN

JIG SPINNING ROD | M | MH

The Caldia Sensor Jig models with 3k woven carbon fiber handle section feature an extra-fast taper action.

The carbon fiber handle section offers great advantages especially when fishing at warmer temperatures and with thin clothing: Lure action, contact to the bottom or soft taps of the fishes are transmitted straightly to the lower arm by the Sensor Jig! Thanks to the carbon fiber handle section every information is forwarded directly to the arm. Additionally, these rods allow utmost accurate scanning of the bottom structure. Further advantages of this special design are an optimal rod balance, a great surface feel and an extraordinary look of the handle.

Art.-No.	Length m	CW g	Action	Closed L. cm	Sect.	Guides	Weight g
11422-210	2.10	8-35	extra fast	108	2	8	130
11422-240	2.40	8-35	extra fast	123	2	9	150
11422-270	2.70	8-35	extra fast	139	2	9	165
11422-245	2.40	14-42	extra fast	123	2	9	150
11422-275	2.70	14-42	extra fast	139	2	9	165



CALDIA



CALDIA LIGHT SPIN

SPINNING ROD | UL | L

The two Caldia spinning rods with casting weights of 1-6g and 3-12g are especially designed for the requirements of fishing at rivers, streams and trout ponds. The lightweight rods with tubular tip perfectly load also when using small lures and catapult small soft plastic lures, plugs and spoons to large distances. Due to the stiff backbone, full lure control and bite detection are ensured also at strong currents – perfect for effective and accurate fishing for perch, trout and chub!

Art.-No.	Length m	CW g	Action	Closed L. cm	Sect.	Guides	Weight g
11425-195	1.95	1-6	extra fast / fast	101	2	8	100
11425-200	2.00	3-12	extra fast / fast	103	2	8	105

CALDIA JIGGERSPIN

JIG SPINNING ROD | ML

Rods with distinct tip action for fishing with soft plastic lures. The actions of the Caldia Jiggerspin allow you to scan the bottom very precisely and offer the necessary elasticity to enable perch, zander and pike to swallow the lure without feeling too much resistance. As a consequence, the hooking of fishes works reliably, no matter whether you are classically jigging or using Texas, Carolina or Dropshot rigs.

Art.-No.	Length m	CW g	Action	Closed L. cm	Sect.	Guides	Weight g
11426-240	2.40	7-28	extra fast / fast	123	2	9	140
11426-270	2.70	7-28	extra fast / fast	139	2	9	150

CALDIA EXTRA FAST SPIN

SPINNING ROD | MH

With the Caldia Extra Fast models DAIWA offers two rods especially for the use of large and heavy softlures as well as for applying deep-running and heavy crankbaits that are presented best in an aggressive manner. The action is characterized by a strong backbone with an appropriately soft tip in the upper quarter of the rod. As a result, the presentation of heavy lures and the fight with large specimen under ambitious conditions are no problem! Also a perfect choice for fishing with the popular chatterbaits! Ideal rods for fishing from the boat!

Art.-No.	Length m	CW g	Action	Closed L. cm	Sect.	Guides	Weight g
11425-205	2.05	20-60	extra fast	106	2	8	130
11425-225	2.25	20-60	extra fast	116	2	8	135



- HMC+® carbon fiber blank
- Upside-down carbon surface
- Spigot put over joint
- Separated cork / carbon fiber grip
- Fuji® Skeleton reel seat
- Tubular tip
- Seaguide® Zirconia guides



CALDIA SENSOR SPIN

SPINNING ROD | UL | L | ML

The Sensor Spin models from the Caldia range are designed for light and ultra-light fishing with softlures and plugs. Due to the fast blank action lures like small shads at the Flexi Jig system, mini plugs and small spoons can be cast to long distances with high accuracy. Lure action and bite are transmitted till the handle section and guarantee pure fishing fun. The ergonomically shaped carbon fiber handle additionally supports the lure contact and bite indication. The lineup comprises rods from 2.10m to 2.70m with three different casting weights and offers the proper model for almost every water type and light and ultra-light lures. Perfect fun rods for perch, zander, chub and trouts!

Art.-No.	Length m	CW g	Action	Closed L. cm	Sect.	Guides	Weight g
11427-210	2.10	0.5-6	extra fast / fast	108	2	9	115
11427-211	2.10	3-10	extra fast / fast	108	2	9	120
11427-212	2.10	4-18	extra fast / fast	108	2	9	125
11427-230	2.30	0.5-6	extra fast / fast	117	2	9	125
11427-231	2.30	3-10	extra fast / fast	117	2	9	130
11427-232	2.30	4-18	extra fast / fast	117	2	9	135
11427-270	2.70	0.5-6	extra fast / fast	139	2	10	145
11427-271	2.70	3-10	extra fast / fast	139	2	10	150
11427-272	2.70	4-18	extra fast / fast	139	2	10	155





WILDERNESS SPINNING

The Wilderness series has been especially designed for hunting salmonid species at streams, rivers, lakes and at the shorelines of the Baltic and North Sea. The range of this specialty rod series has been exactly matched for the target species like sea and lake trout, rainbow trout, char and taimen. Of course, some models are also perfectly suited for targeted fishing for perch, chub and pike.

The lightweight HMC+ carbon fiber blank is exclusively equipped with premium components - reel seat from Fuji with state-of-the-art screw-nut and lightweight XO guides from Seaguide together with the noble cork handle offer extraordinary equipment for rods within this price range.

- HMC+® carbon fiber blank
- Spigot put over joint
- Brading-X handle section
- Premium cork grip
- Fuji® reel seat
- Seaguide® titanium oxide guides



WILDERNESS TROUT

SPINNING ROD | L | LML

The trout rods of the Wilderness series are designed for application at small streams as well as at trout ponds and lakes. The slim and lightweight blank gently loads even with lightweight baits and instantly resiles after the cast. This characteristic allows long and at the same time targeted casts. The action of the backbone has been chosen to support a safe fight with the fish, since it buffers fierce flights and jumps perfectly. During the fight the blank of the Wilderness Trout turns into a semi-parabolic action and absorbs headbutts perfectly. The Fuji TVS reel seat is pleasant to handle and equips these rods with a slim and delicate look. Equipped with tubular tip.

Art.-No.	Length m	CW g	Action	Closed L. cm	Sect.	Guides	Weight g
11872-200	2.00	2-10	medium fast	103	2	8	100
11872-210	2.10	4-14	medium fast	108	2	8	105
11872-240	2.40	6-18	medium fast	123	2	8	120

WILDERNESS SEA TROUT

SPINNING ROD | ML | M | MH

Within the sea trout rods of the Wilderness series you find rods for both fishing from the shore and from the boat. With the 8-28g casting weight rods you are perfectly equipped for fishing with smaller lures in shallow areas. The two long rods with casting weights up to 35g or 45g are reals long casting champions and catapult also heavy spoons against headwinds. Thanks to the soft tip these rods are also perfectly suited for the use of braided lines.

Art.-No.	Length m	CW g	Action	Closed L. cm	Sect.	Guides	Weight g
11872-285	2.85	7-25	medium fast	146	2	10	170
11872-241	2.40	8-28	medium fast	123	2	9	130
11872-295	2.95	10-35	medium fast	151	2	9	175
11872-305	3.05	15-45	medium fast	156	2	9	185



WILDERNESS HUCHO

SPINNING ROD | XH

Two special rods for winter fishing for the largest salmonids of our domestic waters – the Wilderness Hucho has been exactly adopted to the requirements of fishing for taimen. The extra-large guides allow the convenient use of plugs, spoons and shads also under cold conditions during wintertime.

Thanks to the large guide diameter icing occurs significantly slower and the ice can easily be removed from the inlays. The power blank with tip action at the same time absorbs flights and headbutts pleasantly but also offers huge power reserves to control large specimen. The blank transmits even softest taps to the handle section, enabling the angler to scan the bottom structure with high resolution.

Art.-No.	Length m	CW g	Action	Closed L. cm	Sect.	Guides	Weight g
11872-245	2.40	40-110	medium fast	123	2	7	205
11872-275	2.70	40-110	medium fast	139	2	7	225



11873-205



11873-225



WILDERNESS SOLID SPIN

SPINNING ROD | UUL | UL | L | SOLID TIP

The supremely equipped Solid Spin models from the Wilderness series have been designed for the increasingly popular ultra-light fishing for trout, perch and zander. The blanks of the Solid Spin models feature a spliced-in solid carbon fiber tip and a powerful backbone and therefore are fully capable of casting small and lightweight lures to long distances with high accuracy. The sensitive blank transmits all lure actions as well as contact with the fish and the bottom to the handle section and offers enough reserves to force also large specimen securely during the fight.

Art.-No.	Length m	CW g	Action	Closed L. cm	Sect.	Guides	Weight g
11873-200	2.00	2-10	extra fast	103	2	8	105
11873-205	2.00	5-12	extra fast	103	2	8	110
11873-210	2.10	1-5	extra fast	108	2	8	105
11873-225	2.25	2-10	extra fast	116	2	9	115

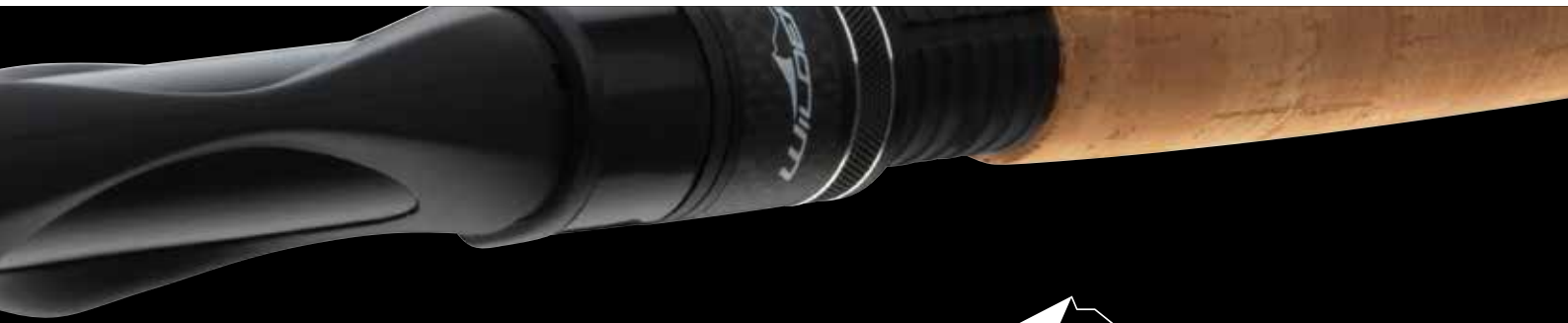

WILDERNESS



WILDERNESS COREGONE

COREGONE ROD | L | SENSI-TIP

The Wilderness Coregone rods have been developed together with our coregone specialists in Austria and Germany and have undergone comprehensive tests. The premium equipment of these rods doesn't leave any wishes unfulfilled. The spigot joint allows the development of extremely slim, lightweight and perfectly balanced blanks, that indicate even softest bites. The action of the HMC+ carbon fiber blanks has been finetuned to allow setting the hook effectively even at fishing in great depths. The parabolic bending curve of the rods reliably buffers flights in the close range and prevents unhooking. Perfect for monofilament and braided line!

The two carbon fiber tips enable you to precisely adapt to the recent water conditions and react to the current behavior of Arctic chars and coregones.

Equipped with premium AAA cork handle and Fuji DPS reel seat.

Art.-No.	Length m	CW g	Action	Closed L. cm	Sect.	Guides	Weight g
11874-215	2.10	3-12	medium fast	108	2+2	10	105
11874-245	2.40	3-12	medium fast	123	2+2	11	120

QUIVERTIPS FOR WILDERNESS COREGONE

Art.-No.	Matching with Rod(s) Art.-No.	Matching with Rod(s) CW g	Color	Type
11874-000Y	11874-215, 11874-245	3-12	yellow	LQ
11874-000R	11874-215, 11874-245	3-12	red	MLQ



PREDATOR



FUEGO PREDATOR SPIN

- HMC+® carbon fiber blank
- Upside-down carbon surface
- Reliable put-over joint
- Fuji® reel seat
- Seaguide® guides



FUEGO PREDATOR SPIN

NEW

SPINNING ROD | L-XH

With the Fuego Predator spinning and baitcasting rods, DAIWA offers a complete lineup of modern fishing rods with fast and stiff blanks, which – depending on the model – are suitable for almost all modern lure fishing applications from UL to big bait. The slim blanks made of HMC+ carbon feature high-quality components in a modern design. The original Fuji VSS reel seat is extremely comfortable in the palm and enables fatigue-free fishing. The high-quality Seaguide guides with super-light LS inserts ensure that the line flows silent and with little friction. The special carbon surface in combination with the innovative shaped EVA handles provide an exclusive, modern and very high-quality design.

Art.-No.	Length m	CW g	Action	Closed L. cm	Sect.	Guides	Weight g
11124-200	2.00	3-12	fast	107	2	8	110
11124-210	2.10	5-20	fast	110	2	8	115
11124-216	2.10	7-30	fast	110	2	8	125
11124-240	2.40	10-40	fast	126	2	8	140
11124-241	2.40	15-50	fast	126	2	8	145
11124-242	2.40	30-70	fast	126	2	8	155
11124-243	2.40	40-95	fast	126	2	8	165
11124-270	2.70	10-40	fast	141	2	8	155
11124-271	2.70	15-50	fast	141	2	8	165
11124-272	2.70	30-70	fast	141	2	8	185
11124-273	2.70	40-100	fast	141	2	8	205
11124-300	3.00	10-40	fast	157	2	9	180
11124-301	3.00	20-60	fast	157	2	9	200

FUEGO PREDATOR JIGGER SPIN

NEW

JIG SPINNING ROD | ML

The two jigger models have been designed with smaller guides and a particularly fast tip action – perfect to feel the bottom structure with small softbaits and for picking up fine bites.

Art.-No.	Length m	CW g	Action	Closed L. cm	Sect.	Guides	Weight g
11125-245	2.40	7-32	fast	126	2	9	140
11125-275	2.70	7-32	fast	141	2	9	160



FUEGO



11125-275

11124-242

11124-200

11126-200

FUEGO PREDATOR TRAVEL SPIN

NEW

TRAVEL SPINNING ROD | M | MH

The travel models are not only suitable for fishing trips on vacation – the bending curve, balance and action of both rods are basically very near to classic two-piece rods. Thanks to their compact transport size, the rods can easily be stowed away in your luggage or rucksack.

Art.-No.	Length m	CW g	Action	Closed L. cm	Sect.	Guides	Weight g
11125-246	2.40	15-50	fast	66	4	8	145
11125-276	2.70	20-60	fast	74	4	8	180

FUEGO PREDATOR BAITCAST

NEW

BAITCASTING ROD | ML | M | MH

The three baitcasting rods in the Fuego Predator series cover the most important areas for BC fishing and feature fast tip action blanks with strong backbone and outstanding casting abilities.

The 4-18g version is perfectly suited to target perch, chub and zander with tiny twitch baits and soft lures. The 7-32g model will also cope with bigger hardbaits, deep running cranks and classic zander- and pike soft lures. The 64gr version will efficiently cast big soft- and hard lures same as medium size swim baits for pike and zander.

The baitcast models featuring an ergonomic PTS reel seat from Fuji.

Art.-No.	Length m	CW g	Action	Closed L. cm	Sect.	Guides	Weight g
11126-200	2.00	4-18	extra fast / fast	106	2	9	125
11126-215	2.10	7-32	extra fast / fast	110	2	9	135
11126-225	2.25	18-64	extra fast / fast	115	2	10	160



- HMC+® carbon fiber blank
- Reliable put-over joint
- Cork grip in premium quality
- Fuji® DPS reel seat
- Seaguide® guides



HIGH MODULUS CARBON PLUS



PRECISION ROD COMPONENTS



EXCELER TRADITIONAL SPIN

NEW

SPINNING ROD | M | MH | H

The Exceler Traditional Spin rods complement the popular and proven Exceler Spin series with additional seven rods all featuring a high-quality full cork handle. Casting weights starting from 10-40g, 20-60g and 30-80g, available in lengths 2.40m and 2.70m, as well as a Sea trout rod with a length of 3.15m, cover the most important areas for local predator fishing. With the Exceler Traditional rods, DAIWA provides the suitable tackle for your trout, pike, perch and zander fishing. These rods are basically all-round spinning rods that can be used both with soft lures, plugs and spoons.

Featuring high-quality components from Fuji and Seaguide, the Exceler Traditional Spin rods are available at a very good price-performance ratio.

Art.-No.	Length m	CW g	Action	Closed L. cm	Sect.	Guides	Weight g
11666-240	2.40	10-40	extra fast / fast	123	2	8	140
11666-241	2.40	20-60	extra fast / fast	124	2	8	145
11666-242	2.40	30-80	extra fast / fast	125	2	8	160
11666-270	2.70	10-40	extra fast / fast	138	2	8	185
11666-271	2.70	20-60	extra fast / fast	138	2	8	200
11666-272	2.70	30-80	extra fast / fast	138	2	8	205
11666-310	3.15	15-40	fast	161	2	8	210



EXCELER



11666-240



11666-272



11666-310





EXCELER SPINNING

- HMC+® carbon fiber blank
- Premium EVA grip
- Ergonomic reel seat
- Seaguide® titanium oxide guides
- Hook keeper



EXCELER SPIN

SPINNING ROD | LM | M | MH | H

The Exceler spinning rod series comprises a comprehensive range of modern rods for actively targeting almost all domestic predator species. The slim HMC+ carbon fiber blanks offer a balanced and fast action with strong backbone. Premium components like lightweight Seaguide guides, an ergonomic reel seat and the modern EVA handle considerable contribute to the great balance and performance of these rods.

Art.-No.	Length m	CW g	Action	Closed L. cm	Sect.	Guides	Weight g
11662-226	2.25	5-20	extra fast / fast	116	2	8	120
11662-240	2.40	10-40	extra fast / fast	124	2	8	140
11662-241	2.40	20-60	extra fast / fast	124	2	8	140
11662-242	2.40	40-80	extra fast / fast	124	2	8	165
11662-270	2.70	10-40	extra fast / fast	139	2	8	165
11662-271	2.70	20-60	extra fast / fast	139	2	8	175
11662-272	2.70	40-80	extra fast / fast	139	2	8	195
11662-300	3.00	15-50	extra fast / fast	155	2	8	180



EXCELER

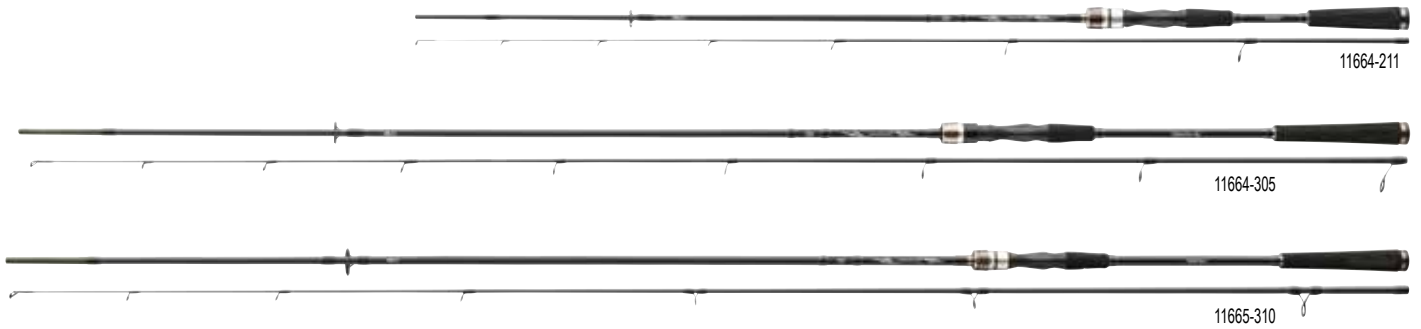

EXCELER SOLIDTIP SPIN

SPINNING ROD | UL | L | SOLID TIP

The two Solid Top rods feature a spliced-in solid carbon fiber tip, paving the way for very long and accurate casts also with very lightweight lures like spoons, mini plugs and shads. The attacks of fishes, the lure action and the bottom contact are perfectly transmitted thanks to the fine tips.

Art.-No.	Length m	CW g	Action	Closed L. cm	Sect.	Guides	Weight g
11664-211	2.10	2-10	extra fast	109	2	8	100
11664-225	2.25	0.5-7	extra fast	116	2	8	110

EXCELER JIGGERSPIN

JIG SPINNING ROD | L | ML

The Jigger and Distance Jig models are characterized by their fast tip action and stiff backbone – perfect features, when softbaits have to be accelerated aggressively even over long distances and softest bites have to be sensed. With the 3.05m models you are capable of reaching enormous casting distances even with small lures, which is especially convenient at gravel pits or canals. Also perfect for overcoming rocky bank reinforcements or presenting the lure straight at the filling edge.

Art.-No.	Length m	CW g	Action	Closed L. cm	Sect.	Guides	Weight g
11664-245	2.40	7-28	extra fast	125	2	8	135
11664-275	2.70	7-28	extra fast	139	2	8	150
11664-305	3.05	3-18	extra fast / fast	155	2	9	165
11664-306	3.05	5-25	extra fast / fast	155	2	9	175

EXCELER SEA TROUT

SEA TROUT ROD | MH

For the ambitious hunt for lake and sea trout, the Exceler Spin series offers a dedicated model, that has been particularly designed for long distance spin fishing. The semi-parabolic blank ideally loads during casting and catapults lures of 15-40g to incredible distances. The soft tip action perfectly buffers sudden flights, headbutts and jumps especially in the close range and therefore reduces the threat of losses. The fine balance of the blank enables fatigue-proof fishing for hours.

Art.-No.	Length m	CW g	Action	Closed L. cm	Sect.	Guides	Weight g
11665-310	3.15	15-40	medium fast	162	2	8	185



LEGALIS

802HFS

LEGALIS

LEGALIS SPINNING HVF

- HVF® carbon fiber blank
- Reliable spigot joint
- Premium EVA grip
- Ergonomic reel seat
- Titanium oxide guides



LEGALIS SPIN

SPINNING ROD | L-H

Great spinning rods with exceptional design.

The Legalis spinning rods display an extraordinary design and come along with outstanding value for money. The slim and well-balanced HVF carbon fiber blank features a pleasant handling, enables long casts and cares for a precise bite detection. During the fight the quick blanks offer enough power reserves to direct also large specimen securely. The V-Joint spigot joint cares for an even bending curve and extra stability under strain.

Equipped with titanium oxide guides and premium Japan-style EVA handle!

Art.-No.	Length m	CW g	Action	Closed L. cm	Sect.	Guides	Weight g
11768-211	2.10	5-20	fast	111	2	8	105
11768-241	2.40	5-20	fast	127	2	8	115
11768-290	2.90	5-35	fast	152	2	9	165
11768-212	2.10	10-30	fast	111	2	8	105
11768-242	2.40	10-30	fast	127	2	8	125
11768-300	3.05	10-40	fast	159	2	9	175
11768-243	2.40	15-50	fast	127	2	8	140
11768-273	2.70	15-50	fast	142	2	8	170
11768-304	3.00	30-60	fast	158	2	9	180
11768-244	2.40	30-70	fast	127	2	8	150
11768-274	2.70	30-70	fast	142	2	8	175
11768-245	2.40	50-100	fast	127	2	8	165
11768-275	2.70	50-100	fast	142	2	8	190



LEGALIS UL SPIN

SPINNING ROD | UL

The Legalis Ultra-Light spinning rods are equipped with a fine tubular tip and thus a fast tip action - ideal for fishing for perch, chub and trout with small shads or hardbaits from 2g on.

During the fight with the fish, the well balanced HVF carbon fiber blanks show a semi-parabolic action and ensure maximum fighting fun!

Art.-No.	Length m	CW g	Action	Closed L. cm	Sect.	Guides	Weight g
11768-190	1.90	2-12	fast	103	2	8	85
11768-210	2.10	3-15	fast	111	2	8	100

LEGALIS JIGGERSPIN

JIG SPINNING ROD | ML | M

The jiggerspin rods of the Legalis series are special rods for fishing for pike, perch and zander with softbaits.

The fast tip action of the HVF blanks enables a perfect jigging of the lure and thus an outstanding lure presentation and controll. The strong backbone transfers contact to the ground, lure or fish directly to the handle section and thus ensures an effective hooking as well as enormous power reserves during the fight with big specimen.

Art.-No.	Length m	CW g	Action	Closed L. cm	Sect.	Guides	Weight g
11768-248	2.40	7-28	fast	127	2	9	120
11768-247	2.40	8-35	fast	127	2	9	130

忍 NINJA 者



NINJA X SPINNING



- HMC+® carbon fiber blank
- DPS reel seat
- Seaguide® guides



NINJA X SPIN

NEW

SPINNING ROD | L-H

Classic spinning rods with tip action.

The Ninja X spinning rods are suitable for almost all common lures and methods for predator fishing – designed as genuine all-round spinning rods! Ideal for fishing with soft baits, plugs, spoons and spinners. The thin handle section offers great power reserves and an outstanding casting and bending performance – so you can always keep control when fighting large fish.

Art.-No.	Length m	CW g	Action	Closed L. cm	Sect.	Guides	Weight g
11204-210	2.10	3-15	fast	109	2	7	120
11204-211	2.10	5-20	fast	109	2	7	125
11204-212	2.10	10-30	fast	109	2	7	135
11204-240	2.40	5-20	fast	124	2	8	140
11204-241	2.40	10-30	fast	124	2	8	155
11204-242	2.40	15-50	fast	124	2	8	160
11204-243	2.40	30-70	fast	124	2	8	185
11204-244	2.40	50-100	fast	124	2	8	195
11204-270	2.70	15-50	fast	139	2	8	195
11204-271	2.70	30-60	fast	139	2	8	205
11204-272	2.70	40-80	fast	139	2	8	215
11204-300	3.00	30-60	fast	154	2	8	225

NINJA X SOLID SPIN

NEW

SPINNING ROD | UL | L

The Solid Spin models in the Ninja X series are featuring very sensitive solid carbon tips that are virtually unbreakable under normal fishing conditions. These tips, in combination with the strong backbone, are ideal to cast light plugs, spoons or spinners to far distance and keep full control over your lure action. The action and bending curve of the blank have been designed to guarantee a maximum of fun and to avoid losing fish during the fight. The well-balanced, thin blanks of the rods transfer every lure movement, fish-, and bottom contact directly up to your hand.

Art.-No.	Length m	CW g	Action	Closed L. cm	Sect.	Guides	Weight g
11204-190	1.90	1-9	fast	99	2	8	105
11204-213	2.10	3-12	fast	109	2	8	115



NINJA X JIGGERSPIN

NEW

JIG SPINNING ROD | L | ML

The very light and particularly fast blanks of these classic jig spinning rods are equipped with slightly smaller guides for better sensitivity and for the use with thin braided lines. The lure action, bottom contact, and even light bites are transferred directly into the handle to the fisherman.

Art.-No.	Length m	CW g	Action	Closed L. cm	Sect.	Guides	Weight g
11203-245	2.40	8-35	extra fast / fast	124	2	8	155
11203-246	2.40	7-28	extra fast / fast	124	2	8	150
11203-275	2.70	8-35	extra fast / fast	139	2	8	170
11203-276	2.70	7-28	extra fast / fast	139	2	8	160

NINJA X LIGHT SPIN

NEW

SPINNING ROD | LM

The two Light Spin versions with tip action have especially been developed to use small soft lures, plugs and jig spinners. Perfectly suitable to target Perch, Zander and Chub.

Art.-No.	Length m	CW g	Action	Closed L. cm	Sect.	Guides	Weight g
11204-220	2.25	4-18	fast	117	2	8	125
11204-255	2.55	4-18	fast	132	2	9	150

NINJA X EXTRA FAST

NEW

SPINNING ROD | M

The Extra Fast model in this series was specially developed for fishing in rough terrain – the particularly strong backbone allows to put heavy pressure on the fish and keep it away from obstacles. Lures such as Chatterbaits, deep-running plugs and heavy soft lures are the lures to go with the Ninja X Extra fast.

Art.-No.	Length m	CW g	Action	Closed L. cm	Sect.	Guides	Weight g
11204-225	2.25	15-40	extra fast	116	2	8	145

忍 NINJA 者



11208-220

- Carbon composite blank
- Premium EVA grip
- Functional screw reel seat
- Seaguide® titanium oxide guides
- Hook keeper



NINJA EXT SPIN

SPINNING ROD | M | MH

The EXT series from the Ninja family is especially made for anglers, who draw attention to a compact closed length but are not into making compromises regarding the rod action. The action of the rods with telescopic handle is hard to distinguish from a 2-sectioned rod. The fast and slim blanks are made of modern composite carbon fiber material and are applicable for fishing with soft- and hardbaits. Thanks to the compact closed length these rods can easily be transported by bike, in the car or local public transport.

Art.-No.	Length m	CW g	Action	Closed L. cm	Sect.	Guides	Weight g
11206-220	2.25	5-30	extra fast / fast	100	3	8	135
11206-221	2.25	15-50	extra fast / fast	100	3	8	150
11206-245	2.45	5-30	extra fast / fast	106	3	8	155
11206-246	2.45	15-50	extra fast / fast	106	3	8	170



EXT SPIN

MOBILE SPIN

X-COMPACT SPIN



11206-220

11207-243

NINJA X MOBILE SPIN

SPINNING ROD | M | MH

The two mobile spinning rods are three-sectioned rods with a special spigot joint concept. The combination of put-in and spigot joint connection allows the design of particularly fast and well-balanced rods with very slim blanks. These rods are characterized by a reduced closed length and offer perfect features for applying soft plastic lures and hardbaits.

Art.-No.	Length m	CW g	Action	Closed L. cm	Sect.	Guides	Weight g
11207-242	2.45	5-30	extra fast / fast	86	3	8	160
11207-243	2.45	15-50	extra fast / fast	86	3	8	170

NINJA X-COMPACT SPIN

TELE SPINNING ROD | M | MH

The two X-Compact rods from the Ninja X series are the most compact spinning rods across the entire DAIWA rod range. The telescopic tip sections with detachable handle feature a closed length of only 50cm – these rods can be easily transported in a backpack or suitcase and are ready-to-fish immediately. The composite carbon fiber blanks with wrapped guides made by Seaguide leave no wish unfulfilled regarding casting and fighting performance and make the Ninja-X-Compact rods a fully adequate companions at every fishing trip.

Art.-No.	Length m	CW g	Action	Closed L. cm	Sect.	Guides	Weight g
11208-220	2.25	5-30	extra fast	50	8+1	8	140
11208-240	2.45	15-50	extra fast	50	9+1	8	170



忍 NINJA 者

KIDS

- HMC+® carbon fiber blank
- Cork / EVA grip
- DPS reel seat
- Titanium oxide double leg guides



NINJA X KIDS

SPINNING ROD | ML | M

With the Ninja X Kids rods DAIWA offers short rods especially designed for being applied by kids and adolescents. The lengths of 1.60m and 1.80m make handling with these rods very easy. The 1.80m long Power Kids model with 20-60g casting weight allows also the use of heavier lures and baits for targeting pike or carp. The action of the HMC+ carbon fiber blanks has been designed to enable good casting distances and make a versatile application possible.

The blanks with robust double leg guides withstand also larger strains!

Art.-No.	Length m	CW g	Action	Closed L. cm	Sect.	Guides	Weight g	Rod Color
11208-160	1.60	10-30	fast	84	2	6	110	blue
11208-161	1.60	10-30	fast	84	2	6	110	pink
11208-180	1.80	20-60	fast	94	2	6	130	green





CROSSFIRE SPINNING

The wide range of the Crossfire Spinning rods covers different casting weight ranges and rod lengths, to provide the matching rod for most types and techniques of modern spin fishing.

Equipped with titanium oxide guide and innovative reel seat, the Crossfire spinning rods perfectly match with our successful Crossfire LT reels.

- Carbon fiber blank
- Separated EVA grip
- Ergonomic reel seat
- Titanium oxide guides



CROSSFIRE SPIN

SPINNING ROD | L-XH

The Crossfire versions above 25g casting weight display a very fast action and are perfectly suited for fishing with shads and plugs. Bite, lure action and bottom structure are perfectly transmitted to the angler.

Art.-No.	Length m	CW g	Action	Closed L. cm	Sect.	Guides	Weight g
11438-210	2.10	5-25	medium fast	109	2	6	120
11438-270	2.70	10-30	medium fast	139	2	8	175
11438-211	2.10	10-40	medium fast	109	2	6	125
11438-300	3.00	10-40	medium fast	155	2	8	210
11438-240	2.40	15-40	medium fast	123	2	8	165
11438-271	2.70	15-40	medium fast	140	2	8	200
11438-241	2.40	20-60	medium fast	123	2	8	180
11438-272	2.70	20-60	medium fast	139	2	8	205
11438-301	3.00	20-60	medium fast	155	2	8	235
11438-242	2.40	40-100	medium fast	123	2	8	190
11438-273	2.70	40-100	medium fast	140	2	8	230
11438-302	3.00	40-100	medium fast	154	2	8	245
11438-243	2.40	50-180	medium fast	123	2	7	195
11438-274	2.70	50-180	medium fast	139	2	8	250



CROSSFIRE



CROSSFIRE JIGGERSPIN

JIG SPINNING ROD | L | ML

The Crossfire Jiggerspin can be recognized by their smaller guides and tip action and are perfectly made for lighter fishing with softbaits and braided lines as well as fishing with Dropshot, Carolina or Texas rig.

Art.-No.	Length m	CW g	Action	Closed L. cm	Sect.	Guides	Weight g
11439-240	2.40	5-25	fast	123	2	8	145
11439-270	2.70	5-25	fast	140	2	8	175
11439-241	2.40	8-35	fast	123	2	8	155
11439-271	2.70	8-35	fast	139	2	8	180

CROSSFIRE UL SPIN

SPINNING ROD | UL

The Crossfire Ultra Light Spin with semi-parabolic action easily casts lightweight lures over great casting distances and guarantees fighting fun.

Equipped with tubular tip.

Art.-No.	Length m	CW g	Action	Closed L. cm	Sect.	Guides	Weight g
11437-150	1.50	2-7	medium fast	77	2	6	90
11437-180	1.80	2-7	medium fast	93	2	6	100
11437-210	2.10	2-7	medium fast	109	2	8	110

CROSSFIRE SEA TROUT

SEA TROUT ROD | ML

The semi-parabolic blank of the Sea Trout model is greatly loading during the cast and reaches enormous distances with spoons and plugs. During the fight, the Crossfire Sea Trout perfectly absorbs escape attempts of sea trouts and lake trouts.

Art.-No.	Length m	CW g	Action	Closed L. cm	Sect.	Guides	Weight g
11438-310	3.00	10-30	medium fast	156	2	8	195



SWEEPFIRE SPINNING

The comprehensive Sweepfire rod range offers the proper rod model for almost every field of application at modern spin fishing. The slim carbon fiber composite blanks are very lightweight and very hard to distinguish from pure carbon fiber rods.

Equipped with aluminum oxide guides, a pleasant cork handle and fresh design, these Sweepfire Spinning rods are available at a familiarly magnificent price-performance ratio.

- Composite blank
- Cork grip
- DPS reel seat
- Aluminum oxide guides



11446-211



11445-150

SWEEPFIRE SPIN

SPINNING ROD | L-XH

Among the models of 5-25g to 50-150g, you will find rods for light to medium spin fishing, as well as for fishing for big pike with heavy XL baits. The blank is made of composite material and very well balanced as well as extremely resilient.

Art.-No.	Length m	CW g	Action	Closed L. cm	Sect.	Guides	Weight g
11446-210	2.10	5-25	medium fast	110	2	7	125
11446-211	2.10	10-40	medium fast	110	2	7	160
11446-240	2.40	10-40	medium fast	125	2	7	165
11446-270	2.70	10-40	medium fast	141	2	8	200
11446-300	3.00	10-40	medium fast	157	2	8	230
11446-241	2.40	15-50	medium fast	126	2	7	190
11446-271	2.70	15-50	medium fast	141	2	8	190
11446-301	3.00	20-60	medium fast	157	2	8	270
11446-242	2.40	30-70	medium fast	126	2	7	195
11446-272	2.70	30-70	medium fast	141	2	8	230
11446-243	2.40	40-100	medium fast	126	2	7	235
11446-273	2.70	40-100	medium fast	141	2	8	240
11446-302	3.00	40-100	medium fast	157	2	8	290
11446-244	2.40	50-150	medium fast	126	2	7	240
11446-274	2.70	50-150	medium fast	141	2	8	260



SWEEPFIRE



SWEEPFIRE UL SPIN

SPINNING ROD | UL

These UL spinning rods are perfectly suited to fish with light spoons, spinners, plastic lures and plugs for salmonids and perch. The slim blank perfectly loads even with light casting weights and is very precise.

Equipped with tubular tip.

Art.-No.	Length m	CW g	Action	Closed L. cm	Sect.	Guides	Weight g
11445-150	1.50	5-10	progressive	79	2	7	95
11445-180	1.80	5-10	progressive	95	2	7	110
11445-210	2.10	5-10	progressive	110	2	7	130

SWEEPFIRE JIGGERSPIN

JIG SPINNING ROD | L | ML

The Sweepfire jig spinning rods are characterized by their distinct tip action with stiff backbone. The small guides at the tip part are made for usage with braided lines and supports the fast action of the blank.

Ideally suited for fishing with softplastic lures, Creature-Baits and twister for perch, zander and pike.

Art.-No.	Length m	CW g	Action	Closed L. cm	Sect.	Guides	Weight g
11447-240	2.40	5-25	fast	125	2	7	160
11447-270	2.70	5-25	fast	141	2	8	180
11447-241	2.40	8-35	fast	125	2	7	170
11447-271	2.70	8-35	fast	141	2	8	185

SWEEPFIRE SEA TROUT

SPINNING ROD | ML

Classic sea trout rod with semi-parabolic action. The Sweepfire Sea Trout enables very long casts and confidently absorbs pounces and escapes of strongly fighting sea trouts and lake trouts.

Art.-No.	Length m	CW g	Action	Closed L. cm	Sect.	Guides	Weight g
11446-310	3.00	10-30	medium fast	157	2	9	235

TRIFORCE TARGET SPINNING

With the Triforce target fish rods you are optimally prepared for most techniques of modern spin fishing! Regardless if you are fishing with small spoons for trout or are using large hardbaits for pike – the Triforce series from DAIWA contains a proper rod for almost every domestic predator species.

The Triforce rods combine ultra-modern design with an exceptional price-performance ratio!



HIGH MODULUS CARBON PLUS

- HMC+® carbon fiber blank
- EVA grip
- Lightweight screw reel seat
- Aluminum oxide guides



11400-190

TRIFORCE TARGET SPOON

TROUT SPINNING ROD | UL | TUBULAR TIP

The Target Spoon rods with parabolic action are perfectly suited for casting light and ultra-light hardbaits to long distances. Fighting fun guaranteed!

Art.-No.	Length m	CW g	Action	Closed L. cm	Sect.	Guides	Weight g
11400-190	1.95	1-8	UL-parabolic	101	2	7	95
11400-210	2.10	2-10	UL-parabolic	109	2	7	105

TRIFORCE TARGET TROUT SPIN

TROUT SPINNING ROD | L

For trout pond and stream you find two light trout rods with semi-parabolic action.

Art.-No.	Length m	CW g	Action	Closed L. cm	Sect.	Guides	Weight g
11400-195	1.95	5-20	semi-parabolic	102	2	7	115
11400-215	2.10	5-20	semi-parabolic	109	2	7	120

TRIFORCE TARGET CASTER SPIN

BAITCASTING ROD | M

When presenting small and medium-sized hardbaits and soft plastic lures using a baitcasting reel, the Triforce Caster with ergonomically shaped trigger reel seat and a casting weight of 7-28g is the rod to choose.

Art.-No.	Length m	CW g	Action	Closed L. cm	Sect.	Guides	Weight g
11405-215	2.10	7-28	medium fast	109	2	9	140

TRIFORCE TARGET PERCH SPIN

PERCH SPINNING ROD | ML

The Triforce Perch rods are wonderfully applicable for small soft plastic lures, spinners or plugs of up to 8cm length.

Art.-No.	Length m	CW g	Action	Closed L. cm	Sect.	Guides	Weight g
11400-216	2.10	10-30	fast	109	2	7	115
11400-245	2.40	10-30	fast	125	2	7	130

TRIFORCE

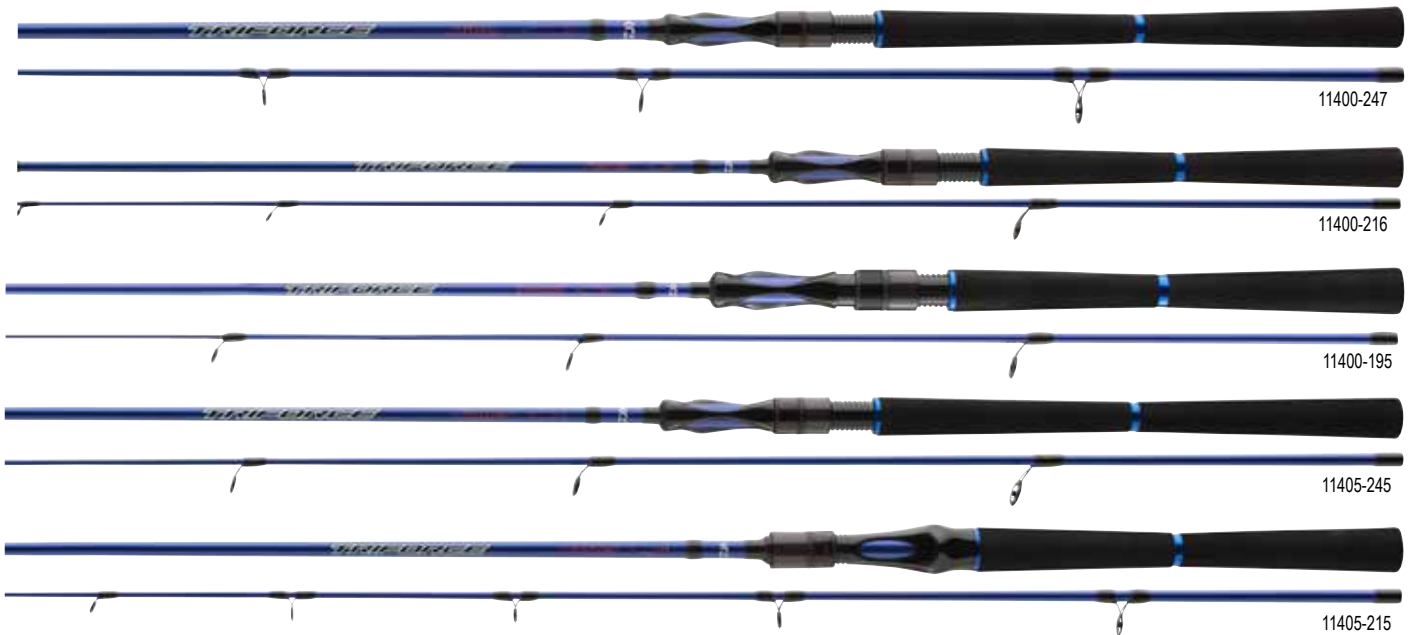

TRIFORCE TARGET JIGGERSPIN

JIG SPINNING ROD | M

The jig spinning rods with markedly fast tip action are especially designed for the use of shads, curly tails and creature baits with the corresponding rigs.

Art.-No.	Length m	CW g	Action	Closed L. cm	Sect.	Guides	Weight g
11405-245	2.40	8-35	fast	124	2	7	140
11405-275	2.70	8-35	fast	139	2	8	185

TRIFORCE TARGET ZANDER SPIN

ZANDER SPINNING ROD | MH

With the Triforce Zander rods you have the fitting tool to present soft und hard lures up to 14cm and 28g.

Art.-No.	Length m	CW g	Action	Closed L. cm	Sect.	Guides	Weight g
11400-246	2.40	15-50	fast	124	2	7	150
11400-276	2.70	15-50	fast	139	2	8	165

TRIFORCE TARGET PIKE SPIN

PIKE SPINNING ROD | H

When you are targeting pike with large and heavy lures up to 70g the pike models are the appropriate choice.

Art.-No.	Length m	CW g	Action	Closed L. cm	Sect.	Guides	Weight g
11400-247	2.40	30-70	medium fast	124	2	7	190
11400-277	2.70	30-70	medium fast	139	2	8	180



MEGAFORCE T R A V E L



HIGH MODULUS CARBON PLUS

- HMC+® carbon fiber blank
- Spigot put over joint
- Brading-X handle section
- Separated EVA grip
- Ergonomic reel seat
- Titanium oxide guides



11253-210



11253-270



11253-300

MEGAFORCE TRAVEL SPIN

TRAVEL SPINNING ROD | L | ML | MH

Travel rods are trendy and offer several advantages not only for travelling anglers. The short division of the Megaforce Travel Spin of only 58cm to 74cm allows the transport of these rods in your travel luggage, avoiding the need for an expensive rod tube. The premium HMC+ blank with spigot joint is very slim, reacts quickly and displays a bending curve, which is hard to distinguish from the actions of two-sectioned rods. These features qualify the Megaforce Travel Spin as full-value fishing rod, which also can be perfectly applied to target predators like pike, zander, perch and trout in domestic waters.

The advantages of the compact closed length especially pay off at fishing trips with the bicycle, storage in the backpack or in public transport.

Equipped with an innovative reel seat and modern EVA handle the Megaforce Travel Spin rods are perfectly balanced and pleasant to handle.

Art.-No.	Length m	CW g	Action	Closed L. cm	Sect.	Guides	Weight g
11253-210	2.10	5-21	medium fast	58	4	7	110
11253-225	2.25	7-25	medium fast	62	4	7	120
11253-240	2.40	10-40	medium fast	66	4	8	155
11253-300	3.00	10-45	medium fast	66	5	9	215
11253-270	2.70	15-50	medium fast	74	4	8	180
11253-241	2.40	30-70	medium fast	66	4	8	175
11253-271	2.70	30-70	medium fast	74	4	8	205



MEGAFORCE S E N S I T I P



HIGH MODULUS CARBON PLUS

- HMC+® carbon fiber blank
- Brading-X handle section
- Separated EVA grip
- Ergonomic reel seat
- Solid tip
- Titanium oxide single leg guides



11251-220



11251-240



11251-260



MEGAFORCE SENSITIP

SPINNING ROD | UL | L

The Megaforce Sensi Tip has been particularly developed for the sensitive fishing at streams rivers and silent waters. The spliced-in solid carbon fiber tip allows a perfect bite detection and accurately transmits lure action and bottom contact. Additionally, this tip enables long casting distances also with very tiny lures.

The strong backbone is the foundation of an alliance, that allows to control also large specimen with light tackle. Perfect for targeting predators like trout and perch with small hard and softbaits. Also a very good choice for targeted finesse fishing for zander.

Equipped with an innovative reel seat and EVA handle the Megaforce Sensi Tip is perfectly balanced and pleasant to handle.

Art.-No.	Length m	CW g	Action	Closed L. cm	Sect.	Guides	Weight g
11251-200	2.00	0.5-6	extra fast / fast	102	2	8	100
11251-220	2.20	1-9	extra fast / fast	115	2	8	110
11251-240	2.40	2-14	extra fast / fast	125	2	9	120
11251-260	2.60	3-18	extra fast / fast	136	2	11	135
11251-241	2.40	4-21	extra fast / fast	125	2	9	125

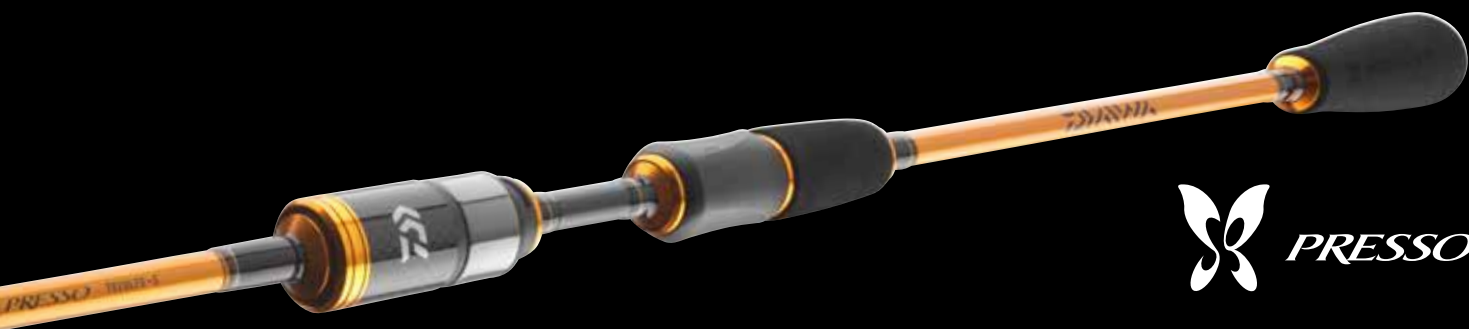

- HVF® carbon fiber blank
- V-Joint® put-over joint
- Premium EVA grip
- Fuji® Skeleton reel seat
- Fuji® Alconite K-guides
- Hook keeper

HVF



V-JOINT



11718-191

11718-210

PRESSO TROUT SPIN

TROUT SPINNING ROD | UL | L

Premium special rods for trout ponds and streams!

The Presso Trout Spin series offers you four valuable special rods for trout fishing and has been particularly matched for the application of all common UL lures at trout ponds. Under load, the lightweight and fast HVF carbon fiber blanks show a harmonic semi-parabolic action. Thanks to the used V-Joint technology the bending curve is especially homogenic. Lightweight Fuji Alconite-K guides support the fast resilience of the rods – allowing extremely accurate casts.

The two models with a spliced-in solid carbon fiber tip and a casting weight of 0.5-5g are especially convenient for applying extremely lightweight spoons – the sensitive tips perfectly load already at low weights and enable good casting distances.

The two models with tubular tip have been developed for the application of somewhat heavier lures of up to 6g that produce more pressure in the water. With these rods you can perfectly present larger spoons, mini plugs and spinners but also shads.

Equipped with Fuji Skeleton reel seat for an instant contact to the blank and premium EVA handle!

Art.-No.	Length m	CW g	Action	Closed L. cm	Sect.	Guides	Weight g
11718-190	1.90	0.5-5	UL-parabolic	102	2	8	85
11718-210	2.10	0.5-5	UL-parabolic	111	2	8	90
11718-191	1.90	1-6	UL-parabolic	102	2	7	85
11718-211	2.10	1-6	UL-parabolic	111	2	7	90

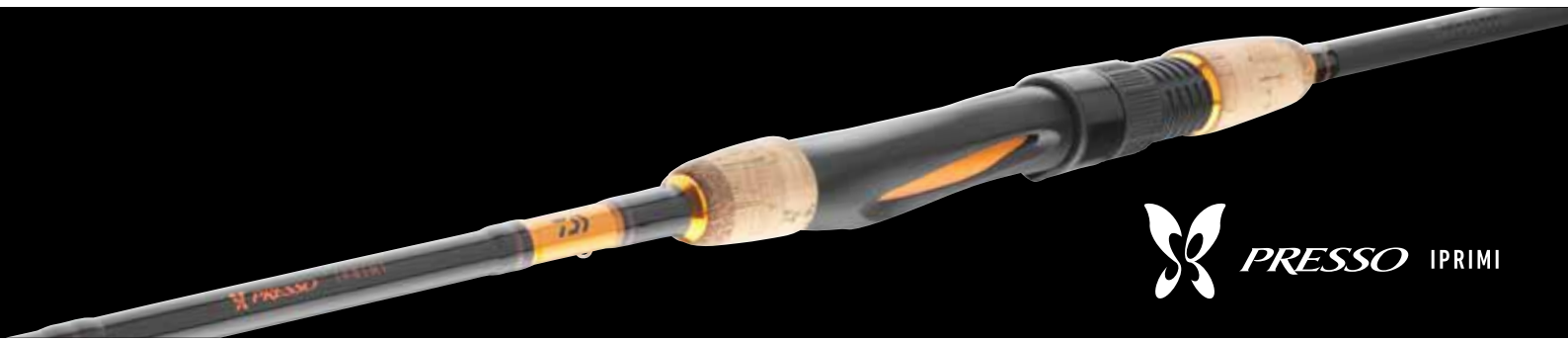

- HVF® carbon fiber blank
- Premium cork grip
- Ergonomic reel seat
- Seaguide® Zirconia guides
- Hook keeper

HVF

Seaguide
PRECISION ROD COMPONENTS



11719-195

11719-216

PRESSO IPRIMI

TROUT SPINNING ROD | UL | L

The Presso Iprimi rods are designed for the application of our small Presso Spoons but of course can also be used with numerous other UL lures like mini plugs or diverse softlures. Due to their special tips, the two Solid-Tip rods with a casting weight of 0.5-6g are especially well-suited for lightweight lures, since the sensitive tips load already at extremely low lure weights and allow great casting distances.

The two rods with tubular tip show their strengths at somewhat heavier lures of up to 7g, that produce more pressure in the water – larger spoons, mini plugs and spinner can be excellently presented with these rods. During the fight the HVF carbon fiber blanks of the Presso Iprimi rods shift to a semi-parabolic action to prevent unhooking – maximum fighting fun guaranteed!

Equipped with premium Seaguide Zirconia guides, ergonomic reel seat and cork handle.

Art.-No.	Length m	CW g	Action	Closed L. cm	Sect.	Guides	Weight g
11719-195	1.95	0.5-6	medium fast	103	2	8	85
11719-215	2.15	0.5-6	medium fast	112	2	8	95
11719-196	1.95	1-7	medium fast	103	2	7	85
11719-216	2.15	1-7	medium fast	112	2	7	90



SILVER CREEK UL / L SPINNING

The Silver Creek spinning rods convince by their modern design as well as premium and innovative rod components and are available at the familiarly outstanding price-performance ratio.

The Silver Creek's reel seat with lateral notches is very handy and supports direct contact to the blank during fishing. The HMC+ carbon fiber blank is very lightweight and especially well-balanced in combination with a spinning reel of sizes 1000-2000.



HIGH MODULUS CARBON PLUS

- HMC+ carbon fiber blank
- Cork / EVA grip
- Ergonomic reel seat
- Titanium oxide guides



11441-180

SILVER CREEK UL SPIN

SPINNING ROD | UL

The Silver Creek Ultra Light Spin offers sensitive and very lightweight spinning rods with spliced-in solid carbon fiber tip. Due to the powerful backbone of the HMC+ carbon fiber blank, also lightweight lures can be securely presented within strong currents at streams.

Art.-No.	Length m	CW g	Action	Closed L. cm	Sect.	Guides	Weight g
11441-180	1.80	3-14	extra fast	95	2	9	100
11441-205	2.05	3-14	extra fast	106	2	9	105
11441-220	2.20	3-14	extra fast	115	2	9	110
11441-235	2.35	3-14	extra fast	122	2	9	115

SILVER CREEK L SPIN

SPINNING ROD | L

The Silver Creek Light spinning rods complete the very popular UL models by four rods with somewhat more powerful spliced-in carbon fiber tip. The tip is almost undestroyable under common fishing conditions and cares – in combination with the powerful backbone of the HMC+ blank – for great casting distances. Ideally suited for softplastic lures of 5-10cm.

Art.-No.	Length m	CW g	Action	Closed L. cm	Sect.	Guides	Weight g
11441-181	1.80	5-21	extra fast	94	2	9	100
11441-206	2.05	5-21	extra fast	106	2	9	105
11441-221	2.20	5-21	extra fast	115	2	9	110
11441-236	2.35	5-21	extra fast	122	2	9	115

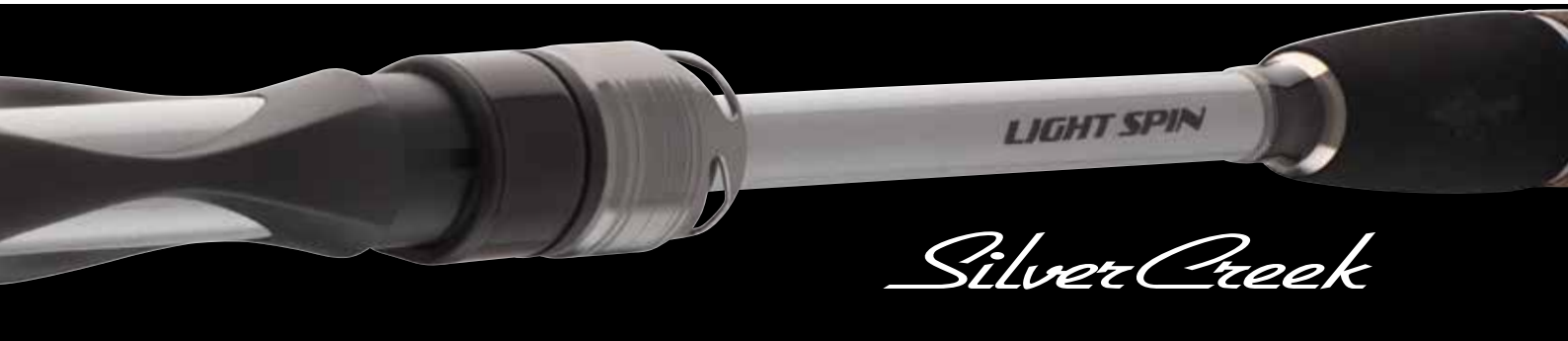

SILVER CREEK UL SPOON

TROUT SPINNING ROD | UL

The Silver Creek Spoon models have especially been developed for fishing with ultra-lightweight spoons for salmonids. The fully parabolic blank perfectly loads even with weights of 1g and reaches remarkable casting distances. These rods guarantee an absolutely spectacular fighting fun!

Equipped with tubular tip.

Art.-No.	Length m	CW g	Action	Closed L. cm	Sect.	Guides	Weight g
11440-170	1.70	0.5-5	semi-parabolic	87	2	7	80
11440-190	1.90	0.5-5	semi-parabolic	98	2	8	85
11440-230	2.30	0.5-5	semi-parabolic	117	2	8	105

SILVER CREEK UL FAST SPOON

TROUT SPINNING ROD | UL

Both Fast Spoon models show a somewhat faster action and are perfectly made for fishing with ultra light plugs and softbaits. The Silver Creek Fast Spoon reaches its target very precisely and offers optimal bite detection and lure control!

Equipped with tubular tip.

Art.-No.	Length m	CW g	Action	Closed L. cm	Sect.	Guides	Weight g
11440-180	1.80	1-6	medium fast	94	2	9	90
11440-210	2.10	1-6	medium fast	109	2	9	95



忍 NINJA 者

- HMC+® carbon fiber blank
- Ergonomic grip design
- Skeleton reel seat
- Seaguide® guides



NINJA X SPOON TROUT

NEW

TROUT SPINNING ROD | UUL | UL

The Trout Spoon models from the well-known and successful Ninja series have been designed to the latest requirements of modern area trout fishing. The very slim and fast HMC+ carbon blanks offer perfect characteristics for using a variety of specialized lure types for area trout. The two models with very sensitive solid carbon tip have been developed for particularly light and delicate lures, weighing 1.5-5g and can also be used to fish the lightest spoons and wobblers on long distances. The two rods with 2-6g casting weight featuring a tubular tip and are designed for use with slightly heavier spoons, small soft lures and small plugs. The Ninja Spoon rods offer excellent value for money!

Art.-No.	Length m	CW g	Action	Closed L. cm	Sect.	Guides	Weight g
11202-195	1.95	1.5-5	fast	105	2	8	95
11202-215	2.15	1.5-5	fast	115	2	9	105
11202-196	1.95	2-6	medium fast	105	2	8	95
11202-216	2.15	2-6	medium fast	115	2	9	100



忍 NINJA 者





LEGALIS



HIGH MODULUS CARBON PLUS

- High modulus carbon fiber blank (HMC)
- Titanium oxide single leg guides with slidable guide
- Hook keeper



11760-425



LEGALIS TELE TROUT

LAKE TROUT ROD | CW 5-25G

Especially developed for fishing for trouts.

The noble Legalis Trout rods have been especially designed for the use in trout ponds. The slim blanks are exceptionally well-balanced and allow very good casting distances with Sbirolinos or Bombardas. The sensitive tip cares for an optimal bite detection and together with the semi-parabolic action leads to a harmonic bending curve. Thus, quick flights are absorbed easily and the rod is protected from overloading. Excellent rods with premium processing and a great price-performance ratio.

Equipped with titanium oxide single leg guides and sliding ring.

Art.-No.	Length m	CW g	Action	Closed L. cm	Sect.	Guides	Weight g
11760-365	3.60	5-25	semi-parabolic	126	4	6	160
11760-395	3.90	5-25	semi-parabolic	126	4	6	160
11760-425	4.20	5-25	semi-parabolic	126	4	6	165



LEGALIS



- HMC+® carbon fiber blank
- Separated cork / EVA grip
- CNC-machined aluminum reel seat
- Seaguide® titanium oxide guides



LEGALIS ALLROUND

ALL-ROUND ROD | CW 10-50G | 30-90G | 40-120G

The Legalis all-round rods from DAIWA are designed for an extra-wide range of applications.

The semi-parabolic blanks of the Legalis Allround show their strengths especially at fishing with delicate natural baits. They are both suited for fishing with the float and with lead sinkers at the bottom.

Very good casting distances can be achieved thanks to these beautiful and slim blanks that perfectly load. With regard to their harmonic action they prevent damaging or even losses of sensitive hook baits.

The models with 10-50g casting weight are designed for light or medium-heavy float fishing.

The ideal target fishes for these rods are trout, tench, bream, zander or middle-sized carps.

When applying the models with 30-90g and 40-120g casting weight, also heavier leads and floats can be used, which is especially convenient at fishing for large carps, pikes or eels.

The Legalis all-round rods feature a CNC-cut aluminum reel seat, titanium oxide guides and a premium HMC+ carbon fiber blank. Due to their light weight and good balance they are also easily applicable for spin fishing.

Art.-No.	Length m	CW g	Action	Closed L. cm	Sect.	Guides	Weight g
11766-305	3.00	10-50	semi-parabolic	155	2	6	175
11766-335	3.30	10-50	semi-parabolic	170	2	7	185
11766-365	3.60	10-50	semi-parabolic	126	3	7	215
11766-306	3.00	30-90	semi-parabolic	154	2	6	180
11766-366	3.60	30-90	semi-parabolic	126	3	7	235
11766-307	3.00	40-120	semi-parabolic	155	2	6	205
11766-367	3.60	40-120	semi-parabolic	125	3	7	260



PROCASTER



- HMC+® carbon fiber blank
- High-quality cork / EVA grip
- DPS reel seat
- Aluminum oxide guides



11642-330

PROCASTER ALLROUND

ALL-ROUND ROD | CW 10-40G | 20-70G | 40-110G

Modern all-round rod for experts.

The comprehensive Procaster Allround rod range from DAIWA comprises fitting models for almost all types of fishing with natural baits in domestic waters.

At the Procaster rods premium components and an unpretentious but valuable design form an enjoyable alliance that comes at an excellent price-performance ratio.

The Procaster models with a casting weight of 10–40g are a great choice for fishing with the float.

When large floats or heavy sinkers are applied at fishing for carps or predators, the rods with 20-70g or 40-100g can be applied. The somewhat softer semi-parabolic backbone of these models allows sensitive casting of delicate baits like dough or baitfish over long distances, which can be crucial for success at fishing for trout, zander, eel or pike.

Art.-No.	Length m	CW g	Action	Closed L. cm	Sect.	Guides	Weight g
11641-300	3.00	10-40	semi-parabolic	107	3	7	200
11641-330	3.30	10-40	semi-parabolic	115	3	8	220
11641-360	3.60	10-40	semi-parabolic	127	3	8	250
11641-390	3.90	10-40	semi-parabolic	137	3	8	275
11642-300	3.00	20-70	semi-parabolic	107	3	7	210
11642-330	3.30	20-70	semi-parabolic	117	3	8	225
11642-360	3.60	20-70	semi-parabolic	127	3	8	280
11643-300	3.00	40-110	semi-parabolic	107	3	7	220
11643-330	3.30	40-110	semi-parabolic	117	3	8	235
11643-360	3.60	40-110	semi-parabolic	127	3	8	280

BLACK WIDOW



- HMC+® carbon fiber blank
- Premium cork grip
- DPS reel seat
- Titanium oxide double leg guides



BLACK WIDOW XT BAIT

ALL-ROUND ROD | M | MH | H

With the Black Widow XT Bait DAIWA offers universally applicable rods for using natural baits for targeting predators like pike, zander and eel but also for coarse fishing for tench, bream or carp.

The semi-parabolic HMC+ carbon fiber blank of this rod series loads in an outstanding fashion and allows long casts without damaging or even losing delicate hook baits during the cast.

The models with 20-60g casting weight are literally made for deadbaiting for zander at low current using small baitfish but also are the right selection for presenting fresh worms on a float at fishing for eel.

The casting weight of 30-90g allows the presentation of natural baits on remote spots and enables the angler to apply also heavier sinkers. With these rods, that feature a casting weight of up to 125g, also the fight with a 1m plus pike or a 15kg carp over long distances is not a problem.

The titanium oxide guides and the pleasant cork handle provide the Black Widow XT rods with a valuable appearance.

Art.-No.	Length m	CW g	Action	Closed L. cm	Sect.	Guides	Weight g
11554-300	3.00	20-60	progressive	156	2	7	270
11554-330	3.30	20-60	progressive	117	3	8	320
11554-360	3.60	20-60	progressive	127	3	8	350
11554-301	3.00	30-90	progressive	156	2	7	275
11554-331	3.30	30-90	progressive	117	3	8	325
11554-361	3.60	30-90	progressive	127	3	8	355
11554-302	3.00	50-125	progressive	156	2	7	285
11554-332	3.30	50-125	progressive	117	3	8	330
11554-362	3.60	50-125	progressive	127	3	8	360



EXCELER CATFISH

The components of the Exceler Catfish rods are dimensioned for extreme load situations and a long lifespan. Premium Seaguide double leg guides, overlapping tip guides, spigot ferrules reinforced with two aluminum guides, premium EVA handles, aluminum reel seat and a solid rounded butt cap – these rods are extremely reliable companions at the rivers Ebro and Po as well as at domestic catfish waters!



EXCELER CATFISH SPIN

CATFISH SPINNING ROD | CW -135G | -185G

The lightweight and well-balanced Exceler Catfish spinning rods from DAIWA are the right choice for almost every lure that is appropriate for catching catfish!

The power backbone enables the angler to control large catfish also in difficult situations and to force the fight uncompromisingly. The spigot joint is reinforced with metal rings, leading to a harmonic bending curve and a durable connection of both rod parts. The distinct tip action combined with the strong backbone allow the use of smaller lures for targeting underwater vegetation and fishing in shallow water areas but also are fully appropriate for fishing with heavy soft plastic lures in strong current and great depth. Controlled and accurate casts are possible every time!

The EVA handle section is pleasant to handle and can be cleaned easily if required.

Art.-No.	Length m	CW g	Action	Closed L. cm	Sect.	Guides	Weight g
11819-242	2.40	-135	medium fast	125	2	8	325
11819-272	2.70	-135	medium fast	140	2	8	395
11819-243	2.40	-185	medium fast	125	2	8	330
11819-273	2.70	-185	medium fast	140	2	8	400



- HMC+® carbon fiber blank
- Reliable spigot put-over joint
- Premium EVA grip
- Heavy-duty reel seat
- Seaguide® double leg guides



11818-336



11819-242



11818-276

EXCELER CATFISH BOJE

CATFISH ROD | CW -600G

The Exceleer Catfish Boje rods are the proper tools to work with heavier sinkers and more sophisticated types of bait presentation. The semi-parabolic composite blanks are stiff enough to smash break lines, control the fish over large distances and force also large specimen securely in strong current. Due to the somewhat softer backbone also the fight with smaller and medium sized fishes is real fun!

For both fixed spool and multiplier reels.

Art.-No.	Length m	CW g	Action	Closed L. cm	Sect.	Guides	Weight g
11818-276	2.70	200-600	semi-parabolic	140	2	10	370
11818-306	3.00	200-600	semi-parabolic	155	2	11	440
11818-336	3.30	200-600	semi-parabolic	169	2	12	470



CATFISH

MEGAFORCE CF

MEGAFORCE CATFISH

By introducing the Megaforce Catfish series, DAIWA offers a very successful, resilient and affordable series for targeting huge catfish fishing. A series you can rely on! The strong blanks and components of the Megaforce Catfish rods made of HMC+ carbon fibre also cope with heavy strains of uncompromising catfish fights and offer easy handling. The carbon X-wrapping on the handle section provides extra stability for the backbone and a high-quality look. Even under very high loads, the strong DPS reel seat firmly holds heavy reels without torque. The ergonomically shaped cork front handle is very comfortable to hold and offers secure grip during cast and fighting a fish. The model up to 400g casting weight was developed for float fishing and features a slightly more sensitive tip with strong backbone. The buoy models with a casting weight of up to 600g are designed for heavy bottom rigs and buoy rigs with huge baits and offer uncompromising power for catching even the biggest fish on distance. With the two spinning rods up to 180g casting weight, you can also safely force and control large catfish and achieve long casting distances.

- Carbon fiber blank
- X-wrapping to reinforce the blank
- Brading-X handle section
- DPS reel seat

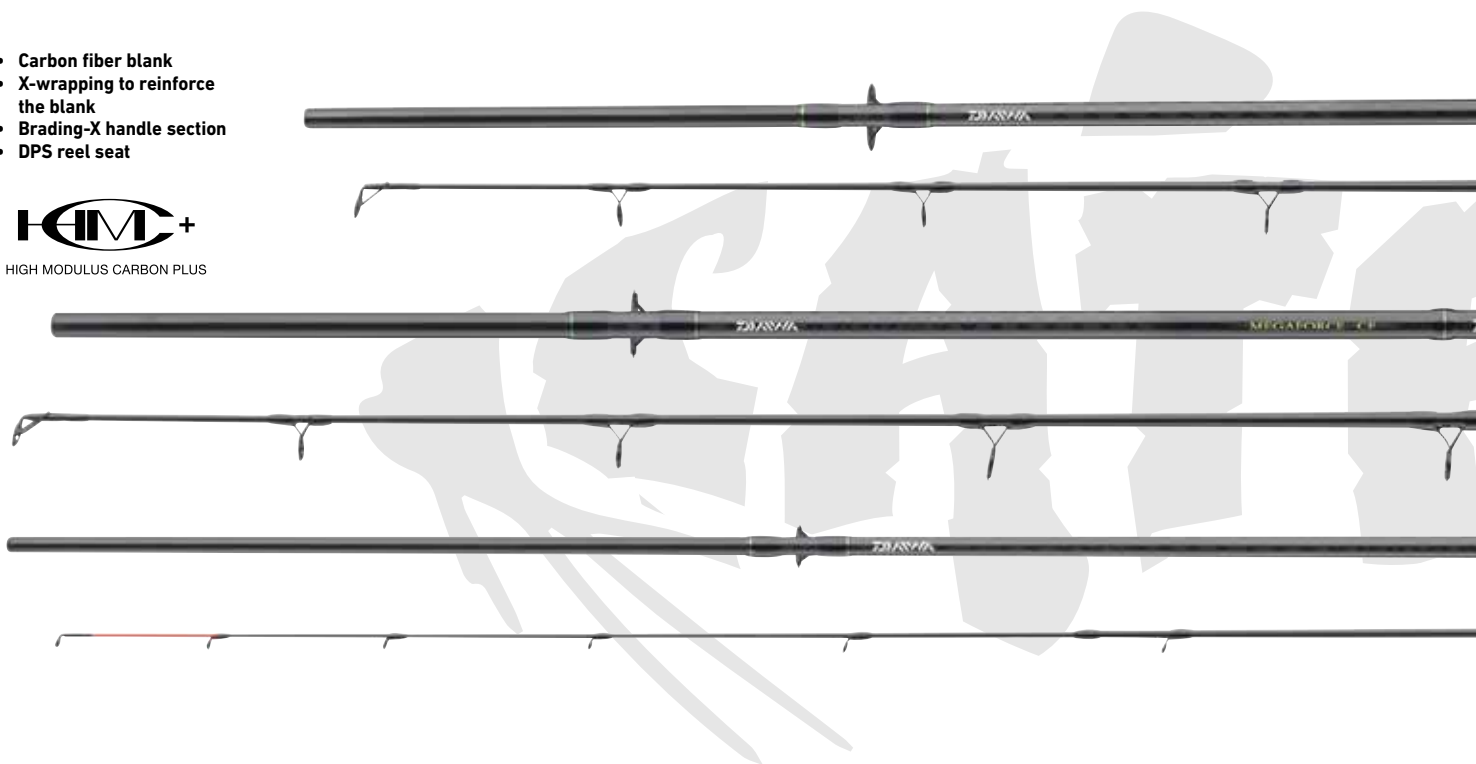

MEGAFORCE CATFISH

NEW

CATFISH ROD | XH | XXH

Art.-No.	Length m	CW g	Action	Closed L. cm	Sect.	Guides	Weight g
11255-270	2.70	100-400	medium fast	141	2	8	390
11255-300	3.00	200-600	medium fast	155	2	9	465
11255-330	3.30	200-600	medium fast	172	2	10	525
11255-245	2.40	up to 180	medium fast	126	2	8	295
11255-275	2.70	up to 180	medium fast	142	2	8	325



MEGAFORCE CF



MEGAFORCE BAITFISH FEEDER

NEW

FEEDER ROD | MH

The Megaforce Catfish lineup also offers a baitfeeder model in 2.7m length for catching baitfish with rigs up to 120g. This versatile rod can be easily used both from the boat and from the bank.

Art.-No.	Length m	CW g	Action	Closed L. cm	Sect.	Guides	Weight g
11255-276	2.70	up to 120	tip action	142	2+2	11	190

QUIVERTIPS FOR MEGAFORCE BAITFISH FEEDER

NEW

Art.-No.	Matching with Rod(s) Art.-No.	Material	Color	Type	TC oz
11255-276Y	11255-276	full carbon fiber	red	HQ	3.00
11255-276R	11255-276	full carbon fiber	yellow	LQ	2.00



忍 NINJA 者

- HMC+® carbon fiber blank



HIGH MODULUS CARBON PLUS



NINJA X BOLO

NEW

BOLOGNESE ROD | CW -25G

The very light and slim carbon blanks of the Ninja Bolognese rods load up over almost the entire length during casting and float rigs up to 25g achieve outstanding casting distances. The fast action in combination with the sensitive tip offer precise casting even with light floats. The lightweight, wrapped guides with Titanium oxide rings additionally support the fast resilience and optimize the balance of the rods. These Bolo rods offer excellent value for money!

Art.-No.	Length m	CW g	Action	Closed L. cm	Sect.	Guides	Weight g
11628-400	4.00	25	progressive	119	4	7	205
11628-500	5.00	25	progressive	122	5	8	275
11628-600	6.00	25	progressive	124	6	9	360



忍 NINJA 者

- HMC+® carbon fiber blank



11628-400



11628-600



11629-500



11629-300



NINJA X POLE

NEW

POLE ROD

Telescopic pole in modern and high quality design. The lightweight HMC+ carbon blank is well balanced and support long term fishing without fatigues. The sensitive tip section prevents overload of thin leaders and provides enjoyable handling.

Art.-No.	Length m	Action	Closed L. cm	Sect.	Weight g
11629-300	3.00	tip action	111	4	90
11629-400	4.00	tip action	111	5	175
11629-500	5.00	tip action	111	6	240
11629-600	6.00	tip action	111	7	315



SWEEPFIRE



11521-300



11521-500

SWEEPFIRE TELEPOLE

POLE ROD

The affordable fiberglass Sweepfire pole rods are ideally suited for fishing for small coarse fish with maggot, corn or dough. This pole should be part of the basic equipment of any predator angler to be all-time ready to catch baitfish.

- Composite blank
- Screwable butt cap

Art.-No.	Length m	Action	Closed L. cm	Sect.	Weight g
11521-300	3.00	progressive	115	3	120
11521-400	4.00	progressive	115	4	215
11521-500	5.00	progressive	115	5	355
11521-600	6.00	progressive	115	6	495

LEGALIS LEGALIS POLE

LEGALIS



11761-400

LEGALIS TELEPOLE

POLE ROD

Lightweight with fast action.

These lightweight and well-processed Legalis Telepole offer an incredible price-performance ratio and convince at first sight. The carbon fiber blanks of these poles are extremely lightweight and well-balanced and offer enough backbone to securely land also larger specimen.

- Carbon fiber blank
- Screwable butt cap

Art.-No.	Length m	Action	Closed L. cm	Sect.	Weight g
11761-400	4.00	semi-parabolic	110	5	160
11761-500	5.00	semi-parabolic	110	6	240
11761-600	6.00	semi-parabolic	110	7	320

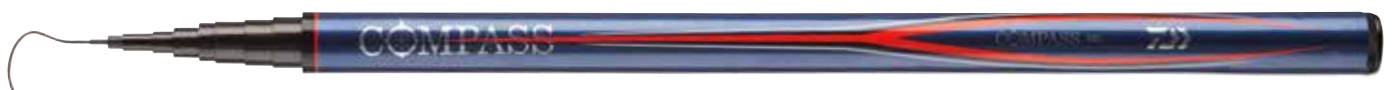

11752-506

COMPASS MOBILE TELEPOLE

POLE ROD

Carbon fiber pole with very short closed length. A closed length of only 42cm allows convenient transportation in almost every fishing bag – perfect for spontaneous fishing trips and catching baitfish!

- Carbon fiber blank
- Screwable butt cap

Art.-No.	Length m	Action	Closed L. cm	Sect.	Weight g
11752-306	3.00	semi-parabolic	42	9	75
11752-406	4.00	semi-parabolic	42	12	135
11752-506	5.00	semi-parabolic	42	15	220
11752-606	6.00	semi-parabolic	42	18	330



BASIA



BASIA X45X CARP

Carp rods from the premium segment!

The Basia X45X carp rod series offers a comprehensive lineup made in the UK. Already at first sight the used components and technologies indicate the extraordinary quality standard – The HVF carbon fiber material is enriched with nano particles according to the Nanoplus technology, leading to the manufacturing of fast, lightweight and at the same time very durable blanks. The X45X technology make these rods extremely distortion-proof and due to the novel processing method leads to a unique surface appearance of the blank.

The exclusive V-Joint Alpha technology at the spigot joint has been further improved by the application of an even more sophisticated BIAS carbon fiber material – the joints are slimmer and the robustness is increased by up to 10%! The reduced material diameter at the joint further improves the bending curve during casting and at the fight with the fish. The premium ALPS ARD reel seat the made of Top-Grade aluminum material and thanks to the double screw secures your reel permanently. Extremely lightweight TDG guides from Seaguide with Adaman coating support the fast resilience of the rods and lead to a prestigious appearance.

The rods are real casting machines, allowing to reach incredible casting distances!

Four models with 12ft und 13ft and a TC of 3.25lbs und 3.75lbs. leave not wishes unfulfilled at long distance fishing. The 12ft Spod and Marker rods complete the lineup of the Basia X45X carp rods.

Equipped with premium Japanese shrinktube handle.

- HVF® Nanoplus carbon fiber blank
- X45X® carbon fiber construction
- V-Joint® Alpha spigot joint
- Premium shrinktube grip
- ALPS® aluminum reel seat with double nut
- Seaguide® TDG guides
- Made in UK

MADE IN THE U.K.



HVF

X45

V-JOINT α

S seaguide
PRECISION ROD COMPONE

ALPS





11995-365



BASIA X45X CARP

CARP ROD | 3.25LB | 3.75LB

Art.-No.	Length ft	TC lb	Closed L. cm	Sect.	Guides	Weight g
11995-365	12.0	3.25	188	2	6	350
11995-366	12.0	3.75	188	2	6	360
11995-395	13.0	3.25	205	2	6	405
11995-396	13.0	3.75	205	2	6	415



INFINITY



HVF



V-JOINT α



ALPS™



- HVF® carbon fiber blank
- X45® carbon fiber construction
- V-Joint® Alpha spigot joint
- Premium EVA / shrinktube grip
- Seaguide® TDG guides
- Made in UK

INFINITY® CARP | 2-SECT.

CARP ROD | 3.25LB | 3.75LB

Art.-No.	Length m	Length ft	TC lb	Action	Closed L. cm	Sect.	Guides	Weight g
11990-365	3.60	12.0	3.25	semi-parabolic	187	2	6	370
11990-395	3.90	13.0	3.25	semi-parabolic	203	2	6	435
11990-366	3.60	12.0	3.75	semi-parabolic	187	2	6	375
11990-396	3.90	13.0	3.75	semi-parabolic	203	2	6	445

INFINITY® STALKER CARP

CARP ROD | 3.00LB | 4.00LB

For carp stalking and boat fishing the Infinity series comprises 10ft. rods, that are especially developed for these purposes. The model with a test curve of 4.0lbs is designed for long distance fishing at large waters. The strong backbone allows you to exert pressure also over long distances during the fight and to control the situation until you get closer to the fish.

The 3.0lbs model features a 40mm starter guide, the 4.0lbs model is equipped with a 50mm starter guide. The Infinity 10ft rods are delivered with Fuji DPS reel seat.

Art.-No.	Length m	Length ft	TC lb	Action	Closed L. cm	Sect.	Guides	Weight g
11990-300	3.00	10.0	3.00	semi-parabolic	156	2	7	290
11990-305	3.00	10.0	4.00	semi-parabolic	156	2	7	295



MADE IN THE U.K. 

INFINITY® CARP

The Infinity Carp rods unite recent DAIWA rod design technology with premium and innovative components.

HVF carbon fiber allows the design of very lightweight, fast and at the same time tough blanks.

The X45 technology significantly improves the twist resistance of the rods. By adding an additional layer in a 45° angle, the carbon fibers which are arranged with a 0° and 90° orientation are perfectly complemented and the blank compression is improved – thanks to this technology, heavier rigs can be casted highly accurate and the rods perform absolutely reliable during casting and the fight with the fish.

The V-Joint Alpha connection improves the bending curve under strain. BIAS carbon fibers, which are arranged in a 45° angle, are combined with a special nano material and allow the design of a spigot joint that is extremely slim but nevertheless highly robust. The V-Joint Alpha connections are up to 10% more durable than our conventional V-Joints and are decreasing the weight at the same time.

These rods are made in the UK and comprise an ALPS reel seat, a Japanese shrinktube handle and TDG guides from Seaguide. TDG guides feature a very hard Adamant coating instead of ceramic inlays. Thus, the inner diameter of the guides is enlarged which leads to an improved casting performance. The black dull blanks are designed as Magnum Taper and load perfectly during the cast. These rods are well-balanced and perfectly suited for long casts!

The Infinity rods show their special quality at first glance and therefore are allocated within the DAIWA premium carp rod range for a very good reason! Made in UK according to highest quality standards!

The 12ft. and 13ft. models feature a 50mm starter guide.

INFINITY® SPOD CARP

CARP ROD | 4.50LB

Art.-No.	Length m	Length ft	TC lb	Action	Closed L. cm	Sect.	Guides	Weight g
11990-368	3.60	12.0	4.50	semi-parabolic	187	2	6	425

INFINITY® MARKER CARP

CARP ROD | 4.25LB

Art.-No.	Length m	Length ft	TC lb	Action	Closed L. cm	Sect.	Guides	Weight g
11990-369	3.60	12.0	4.25	semi-parabolic	187	2	6	420



EMBLEM



EMBLEM XT X45 CARP

With the Emblem XT X45 series DAIWA offers a supremely equipped carp rod series for extreme casting distances!

The application of HVF carbon fiber material together with the Nanoplus technology enabled the manufacturing of very slim, lightweight and fast blanks. The use of the X45 technology optimizes the twist resistance of the blank and cares for accurate casts and optimal fighting characteristics. Compared to the Emblem Carp series the blank diameters could be reduced significantly by improving the casting and fighting characteristics at the same time. The blanks are somewhat more parabolic and are well-balanced. The extra-lightweight TiForged Air guides support the fast action and the resilience of these rods.

The short EVA section at the handle improves the fighting properties under high load and offers safe hold in the Butt Grip.

Beyond a powerful 3.5lbs 10ft Stalker rod the lineup of the Emblem X45 series offers three Long Distance rods with 12ft and 13ft, that are excelled by enormous casting distances.

Equipped with Fuji DPS reel seat, Woven carbon fiber at the handle section, American Tackle TiForged Air Guides and an abbreviated shrinktube handle with EVA finish.

HVF

X45

- HVF® Nanoplus carbon fiber blank
- X45® carbon fiber construction
- 3K Woven carbon fiber blank
- V-Joint® put-over joint
- Separated EVA / shrinktube grip
- Fuji® DPS reel seat



11599-365



EMBLEM XT X45 CARP

CARP ROD | 3.25LB | 3.50LB | 3.75LB

Art.No.	Length m	Length ft	TC lb	Closed L. cm	Sect.	Guides	Weight g
11599-305	3.00	10.0	3.5	157	2	6	260
11599-360	3.60	12.0	3.25	190	2	6	330
11599-365	3.60	12.0	3.75	190	2	6	350
11599-395	3.90	13.0	3.75	205	2	6	385



EMBLEM

- HMC+® carbon fiber blank
- 1K Woven carbon fiber blank
- Premium Hard EVA grip
- Fuji® DPS reel seat
- Seaguide® guides

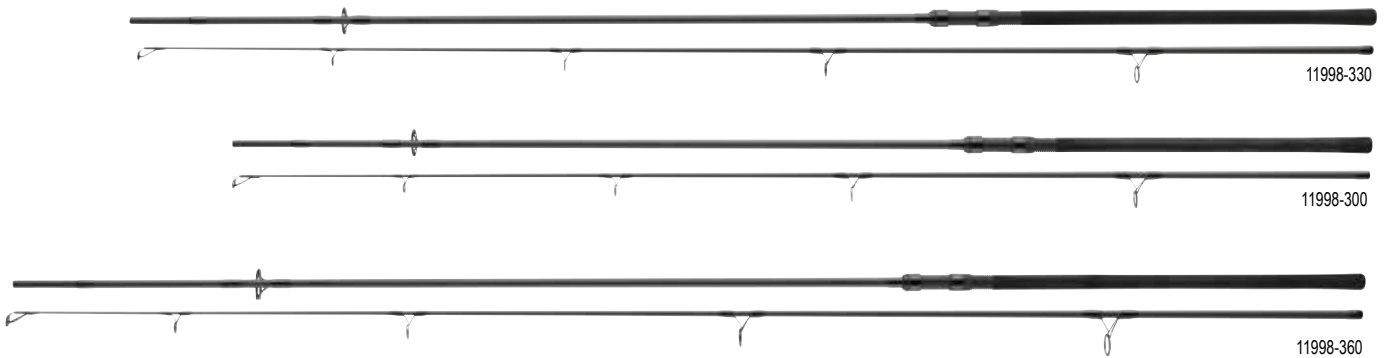

EMBLEM CARP

NEW

CARP ROD | 3.00LB | 3.25LB | 3.50LB

The Emblem Carp rods combine modern rod building technology with high-quality components and an outstanding, elegant design. For the Emblem carp rods, we have developed fast blanks with a progressive but fast tip action paired with outstanding casting and fighting performance. We have paid particular attention to create slim blank diameters and perfect balance. During casting, the 3k woven surface progressively loads up on the entire blank and provides accurate long-distance casts. Sudden runs of big fish can be easily absorbed and controlled. The slim EVA handle section is comfortable to grip when casting and sits firmly on the rod rest.

In addition to the standard range of most popular 10ft. Stalker, 12ft. and 13ft. rods, a 11ft. 3.25lbs test curve model was added. This rod is suitable both from the boat and from the bank and offers extremely precise casting performance and easy handling.

Featuring an original Fuji DPS reel seat and original Seaguide LS guides.

The Emblem Carp offers top features and components at a top price-performance ratio.

Art.-No.	Length m	Length ft	TC lb	Action	Closed L. cm	Sect.	Guides	Weight g
11998-300	3.00	10.0	3.50	progressive	156	2	6	305
11998-330	3.30	11.0	3.25	progressive	172	2	6	340
11998-360	3.60	12.0	3.00	progressive	187	2	6	385
11998-365	3.60	12.0	3.50	progressive	187	2	6	420
11998-390	3.90	13.0	3.50	progressive	203	2	6	455



CROSSCAST XT



CROSSCAST XT CARP

Classic carp rods with noble and timeless design.

The HMC+ carbon fiber blanks offer huge power reserves, a quick resilience and perfect fighting characteristics. During the casts these rods perfectly load and catapult heavy rigs to long distances. The lineup of the Crosscast XT series covers all areas of modern carp fishing.

The 10ft. Stalker rod with a powerful test curve of 3.5lb is the proper selection for fishing over short distances. This rod also allows to control large specimen during the fight from the boat in a safe manner.

The models with 12ft. and 13ft. with 50mm starter guide are exceptional rods for long casts and allow targeting of remote spods.

Equipped with woven carbon fiber at the dull-black blank, titanium oxide guides, premium shrinktube handle and Seaguide DPS reel seat.



- HMC+® carbon fiber blank
- Woven carbon fiber handle section
- Premium shrinktube grip
- Seaguide® DPS reel seat
- Seaguide® titanium oxide guides



CROSSCAST XT CARP | 2-SECT.

CARP ROD | 3.00LB | 3.50LB

Art.-No.	Length m	Length ft	TC lb	Action	Closed L. cm	Sect.	Guides	Weight g
11562-360	3.60	12.0	3.00	semi-parabolic	188	2	6	270
11562-365	3.60	12.0	3.50	semi-parabolic	188	2	6	320
11562-395	3.90	13.0	3.50	semi-parabolic	205	2	6	360

CROSSCAST XT STALKER CARP

CARP ROD | 3.50LB

Art.-No.	Length m	Length ft	TC lb	Action	Closed L. cm	Sect.	Guides	Weight g
11562-305	3.00	10.0	3.50	semi-parabolic	158	2	6	230



CROSSCAST EXTENSION CARP

Powerful carp rods with harmonic bending curve.

The extendable Crosscast version is equipped with telescopic handle section and can thus be transported easily. The rods fit into a holdall of only 130cm length and thus are not too bulky within the car or boat.

The perfect place to be for the Crosscast Extension rods are smaller waters or at fishing from the boat.

The HMC+ carbon fiber blanks convince by their great casting properties and optimal performance during the fight. Seaguide guides with thin titanium oxide LS inlays, a Seaguide DPS reel seat, premium shrinktube at the handle as well as 1K woven carbon fiber at the blank represent an outstanding equipment for rods within this price category.



HIGH MODULUS CARBON PLUS



PRECISION ROD COMPONENTS

- HMC+® carbon fiber blank
- 1K Woven carbon fiber blank
- Premium shrinktube grip
- Seaguide® DPS reel seat
- Seaguide® titanium oxide guides

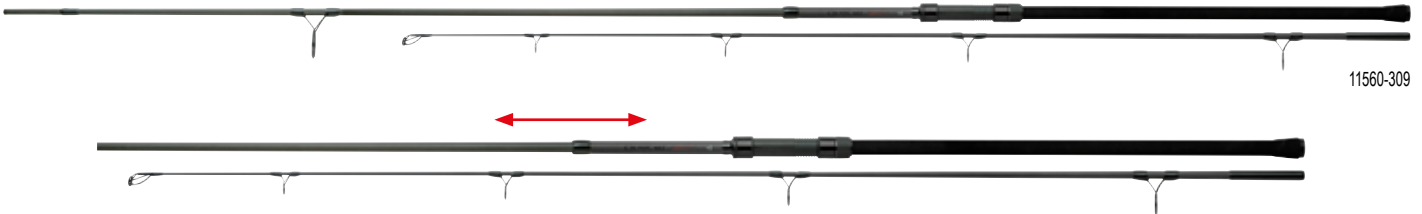

CROSSCAST EXTENSION CARP

CARP ROD | 3.00LB | 3.50LB

Art.-No.	Length m	Length ft	TC lb	Action	Closed L. cm	Sect.	Guides	Weight g
11560-308	3.05	10.0	3.00	semi-parabolic	129	2	6	265
11560-309	3.05	10.0	3.50	semi-parabolic	129	2	6	275

CROSSCAST EXTENSION SPOD CARP

CARP ROD | 4.50LB

Art.-No.	Length m	Length ft	TC lb	Action	Closed L. cm	Sect.	Guides	Weight g
11560-310	3.00	10.0	4.5	semi-parabolic	129	2	6	270



VERTICE

- HMC+® carbon fiber blank
- Carbonized cork grip
- Seaguide® DPS reel seat
- Seaguide® guides



VERTICE CAMO CARP

NEW

CARP ROD | 3.00LB | 3.25LB | 3.50LB | 3.75LB

The Vertice Camo Carp rods are made of the same base blanks as the Vertice Carp rods with shrink tube handle. The thin and slim blank with powerful tip action provides outstanding casting distances and offers enormous power reserves whilst fighting a fish. For the Camo Carp version, our engineers have used a special "Carbonized Cork" material that provides a camouflage like and unique look on the handles. The high-quality blanks made from HMC+ carbon are all featuring original, high-quality Seaguide LS guides and a classic DPS reel seat. Vertice Camo Carp – carp rods with a customized rod building character!

Art.-No.	Length ft	TC lb	Action	Closed L. cm	Sect.	Guides	Weight g
11601-300	10.0	3.25	progressive	157	2	6	280
11601-360	12.0	3.00	progressive	187	2	6	380
11601-365	12.0	3.50	progressive	187	2	6	395
11601-395	13.0	3.75	progressive	203	2	6	480

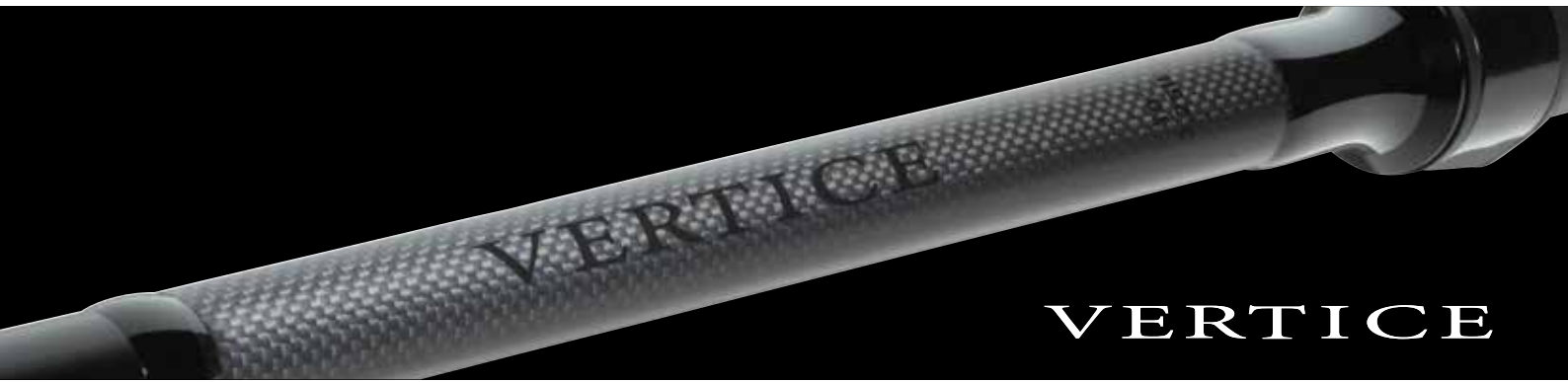

VERTICE

- HMC+® carbon fiber blank
- Premium shrinktube grip
- Seaguide® DPS reel seat
- Seaguide® guides



VERTICE CARP

NEW

CARP ROD | 3.00LB | 3.25LB | 3.50LB | 3.75LB

The very slim HMC+ carbon blanks in the Vertice series have been completely redesigned and improved. The fast and well-balanced blank provides long casting distances with high accuracy and features a distinct tip action with strong power backbone. The elegant design with shrink tube handle, Seaguide DPS reel and 1k woven carbon in the name window creates a timeless appearance.

The original Seaguide guides with thin ceramic rings in premium quality complement the exceptionally high-class features in this price range. The 12ft and 13ft models all featuring a size 50 butt guide. The 10ft Stalker model feature a size 40 butt guide.

Art.-No.	Length ft	TC lb	Action	Closed L. cm	Sect.	Guides	Weight g
11600-300	10.0	3.25	progressive	157	2	6	265
11600-360	12.0	3.00	progressive	187	2	6	345
11600-365	12.0	3.50	progressive	187	2	6	365
11600-395	13.0	3.75	progressive	203	2	6	450



NINJA X CARP

- HMC+® carbon fiber blank
- Reliable put-over joint
- Premium shrinktube grip
- DPS reel seat
- Seaguide® guides



HIGH MODULUS CARBON PLUS



PRECISION ROD COMPONENTS



NINJA X STALKER CARP

NEW

CARP ROD | 2.00LB | 3.00LB

With the two Stalker models in 10ft and test curves of 2.00 and 3.00lb, you are ideally equipped for short range fishing and for boat fishing. The Stalker rods featuring a size 40 butt guide. These rods are also well suited for dead bait fishing for pike or zander.

Art.-No.	Length m	Length ft	TC lb	Action	Closed L. cm	Sect.	Guides	Weight g
11590-300	3.00	10.0	2.00	progressive	157	2	6	255
11590-305	3.00	10.0	3.00	progressive	156	2	6	275

NINJA X CARP | 2-SECT.

NEW

CARP ROD | 3.00LB | 3.50LB

The slim blanks of the Ninja X carp rods made from HMC+ carbon fully load up when casting and can provide enormous casting distances. During the fight, the progressive action of the rods provides the ideal buffer to absorb heavy head shakes and fast runs. Maximum fighting fun is guaranteed. The Ninja X carp rods offer a calm and elegant design and impress with the high-quality components and materials used. The slim shrink tube handle is easy to clean and sits firm and comfortably in the hand and on the bank stick.

Art.-No.	Length m	Length ft	TC lb	Action	Closed L. cm	Sect.	Guides	Weight g
11590-365	3.60	12.0	3.00	progressive	186	2	6	345
11590-366	3.60	12.0	3.00	progressive	186	2	6	360
11590-395	3.90	13.0	3.50	progressive	201	2	6	435



NINJA X CARP | 4-SECT.

NEW

CARP ROD | 3.00LB | 3.50LB

The four-piece Ninja X carp rods can be transported in an extremely space-saving manner and have impressed in numerous field tests despite their multi section construction – the blanks provide excellent casting performance and do not torque. Thanks to those properties, you can hardly feel any difference to usual two-piece constructions. The 12ft model with 3lb test curve is featuring a size 40 butt guide, the 13ft model a size 50 butt guide.

Art.-No.	Length ft	TC lb	Action	Closed L. cm	Sect.	Guides	Weight g
11591-365	12.0	3.00	progressive	95	4	6	320
11591-395	13.0	3.50	progressive	104	4	6	380

NINJA X CARP | 3-SECT.

NEW

CARP ROD | 3.00LB | 3.50LB

The three-section Ninja X carp rods impress with their outstanding casting performance. The slim HMC+ blank of these rods fully loads up during cast and provides perfect balance with a strong backbone. The excellent bending curve is very close to a two-piece carp rod.

Art.-No.	Length ft	TC lb	Action	Closed L. cm	Sect.	Guides	Weight g
11591-366	12.0	3.00	progressive	126	3	6	345
11591-367	12.0	3.50	progressive	126	3	6	360
11591-396	13.0	3.50	progressive	136	3	6	410

BLACK WIDOW XT CARP

Black Widow XT carp rods – a series that really delivers!

The new, super slim and well-balanced blanks made of HMC+ carbon provide a convincing casting and fighting performance and always offer full control. The two Stalker models in 10ft length cover the most important areas of short-range and boat fishing for carp. The lighter 2.00lb version can even be used for float fishing – here, even smaller carp will make great pleasure. With the strong backbone of the 3.50lb 10ft Stalker rod, you can easily fish for large carp, and you will always keep the full control.

The 12ft and 13ft Black Widow XT rods are designed for targeting spots at greater distances. The spod rod with 4.50lb test curve is equipped with a distinctive fast tip action and strong backbone and casts heavy spods precisely on far distances.

The three-piece model in 12ft and 3lbs has been developed for everybody who values a compact transport size and does not want to compromise on casting and retrieving performance.

The two Stalker rods and the 12ft rod with Art. No. 11583-361 featuring a size 40 starter guide. All other Black Widow XT rods feature a #50 starter.

Comes with slim and light titanium oxide guides and slim shrink tube handles. The huge lineup of the Black Widow XT series offers the right rod for almost every application in modern carp fishing.

- HMC+® carbon fiber blank
- Premium EVA / shrinktube grip
- DPS reel seat

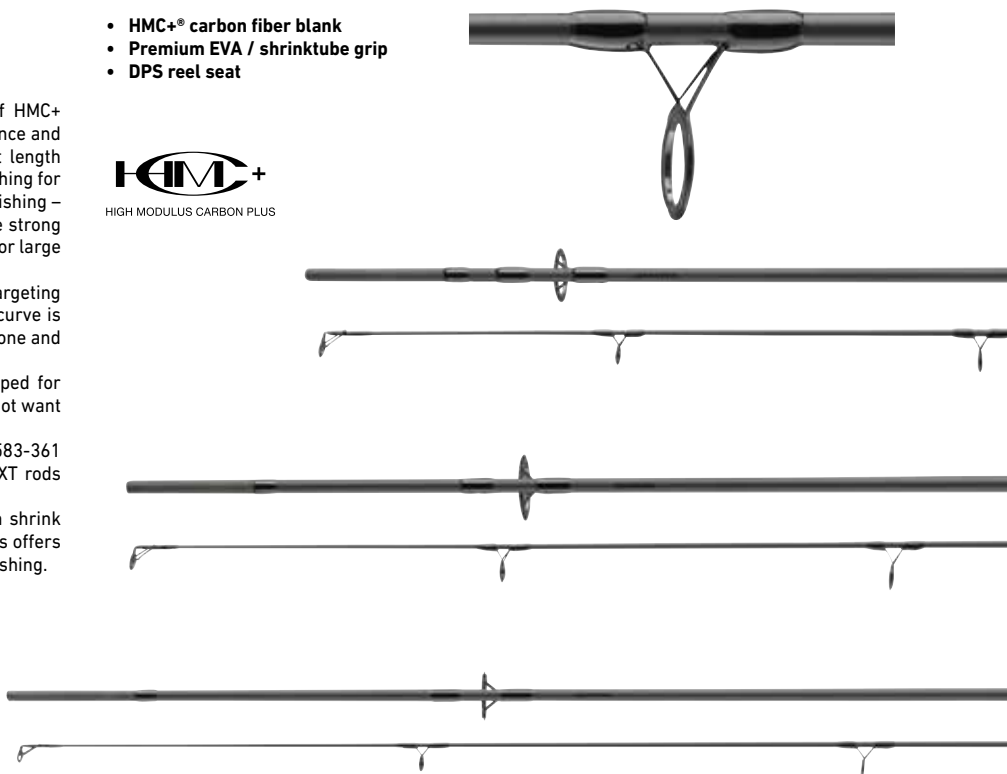

BLACK WIDOW XT STALKER CARP

NEW

CARP ROD | 2.00LB | 3.50LB

Art.-No.	Length ft	TC lb	Action	Closed L. cm	Sect.	Guides	Weight g
11583-305	10.0	2.00	progressive	157	2	6	235
11583-300	10.0	3.50	progressive	157	2	6	255

BLACK WIDOW XT CARP | 2-SECT.

NEW

CARP ROD | 2.75LB | 3.00LB | 3.50LB

Art.-No.	Length ft	TC lb	Action	Closed L. cm	Sect.	Guides	Weight g
11583-360	12.0	2.75	progressive	188	2	6	275
11583-361	12.0	3.00	progressive	188	2	6	295
11583-362	12.0	3.00	progressive	188	2	6	305
11583-365	12.0	3.50	progressive	188	2	6	365
11583-395	13.0	3.50	progressive	200	2	6	375



BLACK WIDOW



BLACK WIDOW XT CARP | 3-SECT.

NEW

CARP ROD | 3.00LB

Art-No.	Length ft	TC lb	Action	Closed L. cm	Sect.	Guides	Weight g
11583-363	12.0	3.00	progressive	128	3	6	325

BLACK WIDOW XT SPOD CARP

NEW

CARP ROD | 4.50LB

Art-No.	Length ft	TC lb	Action	Closed L. cm	Sect.	Guides	Weight g
11583-367	12.0	4.50	progressive	188	2	6	395



CROSSCAST TRADITIONAL CARP

The Crosscast Traditional Carp series comprises rods with classic design and premium equipment. The HMC+ carbon fiber blank with progressive action perfectly loads during the cast and safely absorbs escapes of fishes during the fight. The Seaguide TDG guides with ceramic inlays are especially lightweight and support the quick resilience of the rods, enabling more precise casts. The premium cork handle, woven-carbon fiber and the DPS reel seat from Seaguide complement the pristine appearance of the Crosscast Traditional Carp rods.

- HMC+® carbon fiber blank
- Premium cork grip
- Seaguide® DPS reel seat
- Seaguide® TDG guides



HIGH MODULUS CARBON PLUS



CROSSCAST TRADITIONAL CARP | 2-SECT.

CARP ROD | 3.00LB | 3.50LB

The Crosscast Tradition carp rods with 12ft and 13ft length convince with ideal casting and fighting performance. Due to the lightweight TDG guides the blank instantly resiles and therefore ensures high accuracy at casting. Size 50 starter guides additionally contribute to the casting performance. The long cork handle provides this rods with a perfect balance.

Art.-No.	Length m	Length ft	TC lb	Action	Closed L. cm	Sect.	Guides	Weight g
11912-360	3.60	12.0	3.00	semi-parabolic	190	2	6	325
11912-365	3.60	12.0	3.50	semi-parabolic	190	2	6	355
11912-395	3.90	13.0	3.50	semi-parabolic	205	2	6	365



CROSSCAST



CROSSCAST TRADITIONAL STALKER CARP

CARP ROD | 3.00LB | 3.50LB

Stalker rods are highly popular. The Crosscast Traditional Stalker rods with 10ft. length are designed for application from the boat and for short ranges. The blank features large power reserves at the handle section to control also large specimen during the fight and lead the safely to the net.

Art.-No.	Length m	Length ft	TC lb	Action	Closed L. cm	Sect.	Guides	Weight g
11912-301	3.00	10.0	3.00	semi-parabolic	158	2	6	225
11912-305	3.00	10.0	3.50	semi-parabolic	158	2	6	235



HIGH MODULUS CARBON PLUS

- HMC+® carbon fiber blank
- Premium EVA / shrinktube grip
- DPS reel seat



BLACK WIDOW



11578-305



BLACK WIDOW EXTENSION CARP

CARP ROD | 2.75LB | 3.00LB | 3.50LB | 4.50LB

The extendable version of the Black Widow carp rod series is equipped with a telescopic handle section. The HMC+ carbon fiber rods thus can be transported and stored in a space-saving way. The rod displays a tip action and offers a powerful backbone – ideal for smaller waters, in rough terrain or from the boat, when great pressure is needed for landing heavily fighting fish. Sudden flights are absorbed smoothly.

The Black Widow Extension carp rods are equipped with aluminum oxide guides, fit into a holdall of only 130cm length and offer an outstanding price-performance-ratio!

Art.-No.	Length m	Length ft	TC lb	Action	Closed L. cm	Sect.	Guides	Weight g
11578-270	2.74	9.0	2.75	semi-parabolic	115	2	6	215
11578-300	3.05	10.0	3.00	semi-parabolic	129	2	6	280
11578-305	3.05	10.0	3.50	semi-parabolic	129	2	6	295
11578-307	3.05	10.0	4.50	semi-parabolic	115	2	6	310



SUPER SPOD



HIGH MODULUS CARBON PLUS



- HMC+® carbon fiber blank
- EVA butt grip
- DPS reel seat
- Seaguide® TDG guides



DAIWA SUPER SPOD

CARP ROD | 5.00LB

With the DAIWA Super Spod rods, we offer a range of special rods for usage with heavy bait rockets. The Super Spod's powerful blank resists even largest amounts of bait and thus enables great casting distances. The distortion-proof HMC+ carbon fiber blank casts absolutely precise! The handle section is designed in a way to be handy during the cast but at the same time easy to clean up. Real power-rods!

Art.-No.	Length m	Length ft	TC lb	Action	Closed L. cm	Sect.	Guides	Weight g
11915-305	3.00	10.0	5.00	progressive	158	2	6	315
11915-365	3.60	12.0	5.00	progressive	188	2	6	395
11915-395	3.90	13.0	5.00	progressive	205	2	6	435



忍 NINJA 者

- HMC+® carbon fiber blank
- Cork grip with EVA finish
- DPS reel seat
- Screwable butt cap



11597-305



11597-365

NINJA X TELE CARP

NEW

TELE CARP ROD | 2.00LB | 2.50LB | 3.00LB

The slim and quality made Ninja X Tele Carp rods are made from a slim and lightweight HMC+ carbon blank and satisfy by their outstanding casting performance and good balance. Especially the Ninja X Tele Carp models with 2.0lbs and 2.5lbs test curve are also suitable for heavy float fishing. Perfect to target Eel, Pike and Zander with dead baits as well.

Art.-No.	Length m	Length ft	TC lb	Action	Closed L. cm	Sect.	Guides	Weight g
11597-275	2.70	9.0	2.00	progressive	81	6	5	200
11597-305	3.00	10.0	2.50	progressive	81	6	5	225
11597-365	3.60	12.0	3.00	progressive	86	6	5	300



CROSSCAST



HIGH MODULUS CARBON PLUS

- HMC+® carbon fiber blank
- Shrinktube grip
- DPS reel seat
- Seaguide® titanium oxide guides
- Screwable butt cap



PRECISION ROD COMPONENTS



11586-305



CROSSCAST TELE CARP

TELE CARP ROD | 2.75LB | 3.00LB | 3.50LB

Powerful with harmonic bending curve.

The telescopic models of the successful Crosscast carp rods series are not inferior to detachable rods according design and quality. The woven carbon fiber blank offers enormous power reserves and shows a fast, distinct action, which perfectly absorbs headbutts and flights.

Art.-No.	Length m	Length ft	TC lb	Action	Closed L. cm	Sect.	Guides	Weight g
11586-305	3.00	10.0	2.75	progressive	95	6	6	250
11586-365	3.60	12.0	3.00	progressive	98	7	7	345
11586-395	3.90	13.0	3.50	progressive	102	7	7	380

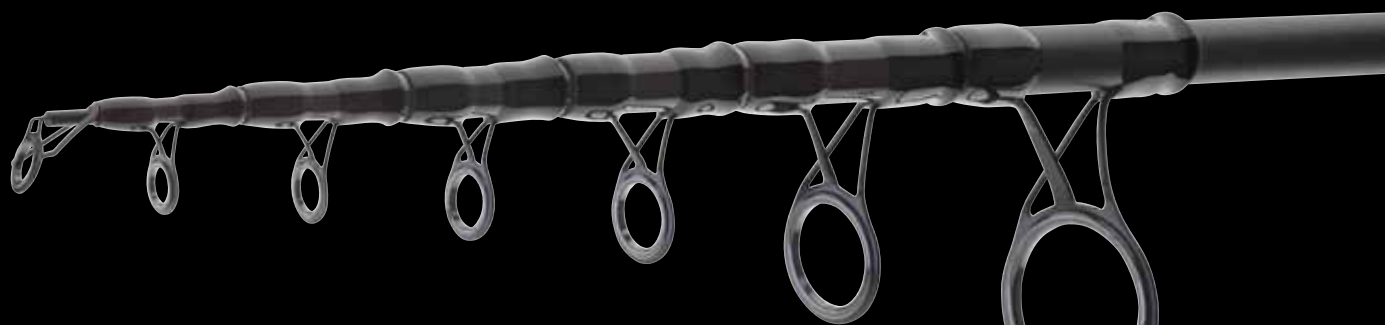

HMC+
HIGH MODULUS CARBON PLUS

BLACK WIDOW



- HMC+® carbon fiber blank
- EVA / shrinktube grip
- DPS reel seat
- Titanium oxide guides



11582-360



11582-390

BLACK WIDOW XT TELE CARP

TELE CARP ROD | 2.50LB | 3.00LB | 3.50LB

The telescopic version of the successful Black Widow XT Carp series convinces by its slim, tight blanks and premium guides. The rod's well-balanced action performs ideally with casting weights of 60g to 100g and reaches great casting distances. During the fight with the fish, the backbone offers enormous power reserves and the possibility to lead even big carps straight into the net without problems. Also catching small to medium catfish up to 1.40m doesn't pose a problem. The rod's compact pack size of little more than one meter enables effortless transportation and quick preparedness at the water.

Art.-No.	Length m	Length ft	TC lb	Action	Closed L. cm	Sect.	Guides	Weight g
11582-360	3.60	12.0	2.50	progressive	102	6	5	215
11582-300	3.00	10.0	3.00	progressive	101	6	5	205
11582-361	3.60	12.0	3.00	progressive	107	7	6	280
11582-390	3.90	13.0	3.50	progressive	115	8	7	345

BLACK WIDOW





AIR Z

MADE IN THE U.K.

- HVF® Nanoplus carbon fiber blank
- X45X® carbon fiber construction
- V-Joint® Alpha spigot joint
- ALPS® reel seat
- AGS® carbon fiber guides
- Exclusive transportation holdall
- Made in UK

HVF
nanoplus

X45X
X45 FULL SHIELD

V-JOINT α

ALPS™



AGS
AIR GUIDE SYSTEM



11186-360



AIR Z AGS FEEDER

NEW

METHOD FEEDER ROD | CW -40G | -50G | -60G | -80G

The DAIWA Feeder Flagship – made in UK!

For these outstanding feeder rods, DAIWA's engineers have used the best, exclusive and most proven material technologies and components. The blanks made of HVF carbon includes Nanoplus technology and are extremely lightweight and perfectly balanced thanks to the exclusive AGS guides. AGS guides from DAIWA are 40% lighter than titanium guides of the same size and enable significant weight savings and improve balance and sensitivity enormously. The X45X Full Shield technology on the blank surface adds tremendous torsional stiffness to the rods and ensures improved power transmission and better casting accuracy. The X45X Full Shield technology improves torsional stiffness by additional 25% compared to conventional X45 technology.

The V-Joint Alpha spigot features an extremely smooth bending curve and thin blanks with simultaneously increased strength. The exclusive ALPS Airpad aluminium reel seat is a lightweight and very robust reel seat that provides a perfect sense of grip in the hand and underlines the exclusivity of the Air Z rods.

The Armlock handle made of high-quality cork and EVA does not twist on the forearm and improves accuracy for casting and fighting. The lineup of the DAIWA Air Z AGS rods is designed for all light feeder and method feeder applications. The rod with 80g casting weight for fishing at very long distances can be fished in dual length of 12ft or 13ft thanks to the additional intermediate section.

The rods are supplied in a high-quality transport holdall with three Megatop quiver tips.

Art.-No.	Length ft	CW g	Action	Closed L. cm	Sect.	Guides	Weight g	Rod Length Length ft
11186-300	10.0	40	progressive	156	2+3	15	170	10.00
11186-330	11.0	50	progressive	171	2+3	16	165	11.00
11186-360	12.0	60	medium fast	127	3+3	16	210	12.00
11186-365	12.0	80	medium fast	136	4+3	16	230	12 13



TOURNAMENT

- HVF® Nanoplus carbon fiber blank
- X45X® carbon fiber construction
- V-Joint® Alpha spigot joint
- Fuji® VSS reel seat
- Seaguide® TDG guides
- Exclusive transportation holdall
- Made in UK



MADE IN THE U.K.



11850-361

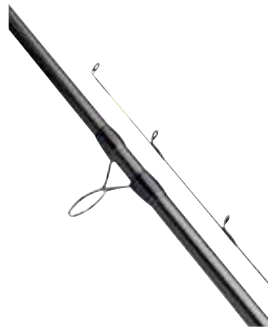

TOURNAMENT SLR FEEDER

NEW

FEEDER ROD | CW -90G | -120G | -150G | -180G

With the UK-made SLR series DAIWA offers a high-end competition series for anglers with the highest demands!

For lighter fishing purpose, the Tournament SLR series includes two 90g rods in 11ft. and 12ft. length – ideal for precise fishing at medium ranges! With the 120g rod in 12ft. DAIWA offers a tool to be fished on long distances in slow-flowing canals or big lakes. The 13ft. 150g rod was designed for use in stronger currents and with large, heavy cages. With the 14ft. 180g casting weight in a length of 14ft, the loaded cage can be cast with accuracy and kept in position at the feeding spot even in strong currents.

The fast blanks made of HVF Nanoplus carbon leave nothing to be desired – extremely light, perfectly balanced and designed for precise casting. The X45X Full Shield technology ensures enormous torsional stiffness of the blank and aids for longer and more accurate casting. The V-Joint Alpha technology supports the construction of outstanding slim blanks. The bending curve is improved, and simultaneously, durability is increased.

The use of very lightweight TDG guides from Seaguide with Adamant coating additionally supports the fast resilience. The high-quality VSS reel seat from Fuji sits comfortably and torque free in the hand. The exclusive Armlock handle design prevents the rod from twisting on the forearm and improves control and accuracy during use.

Art.-No.	Length ft	CW g	Action	Closed L. cm	Sect.	Guides	Weight g
11850-330	11.0	90	medium fast	172	2+3	13	192
11850-360	12.0	120	medium fast	187	2+3	14	199
11850-361	12.0	90	medium fast	127	3+3	14	203
11850-390	13.0	150	medium fast	137	3+3	14	237
11850-420	14.0	180	medium fast	148	3+3	14	281



TOURNAMENT

- HVF® Nanoplus carbon fiber blank
- V-Joint® Alpha spigot joint
- ArmLock® handle section
- High-quality cork / EVA grip
- Original DAIWA® reel seat
- Seaguide® TDG guides
- Made in UK



V-JOINT α



MADE IN THE U.K. 



11185-360



TOURNAMENT S FEEDER

NEW

FEEDERRUTE | WG -40G | -50G | -120G

The Tournament-S feeder rods – made in the UK – the revival of a legendary series! The blanks of the two Method Feeder models with 40g and 50g casting weight have an very even and progressive bending curve and counteract material fatigue during casting and handling fish thanks to the special material combination. Due to the combination of lightweight Seaguide TDG guides and HVF carbon material with Nanoplus technology, the blanks react and recover very quickly after casting. The V-Joint Alpha spigot connection supports the engineering of particularly thin blanks and considerably improves the bending curve and recovery. The lightweight tip sections made of HVF support the excellent rod balance. With the 120g rod in 13.6ft length, you are ideally equipped for distance fishing on large still waters or in light currents. This rod offers excellent resilience, fast action and an exceptional balance.

The exclusive DAIWA Armlock handle improves handling and control during casting and handling fish. The flattened handle section perfectly sits on the forearm, preventing the rod from twisting. The lightweight DAIWA Tournament reel seat is made from a high-quality carbon composite material, is torsion-resistant and is only applied in selected series.

The 11ft and 12ft rods are supplied with three Megatop quivers. The 13.6ft rod is equipped with three carbon quiver tips.

Art.-No.	Length ft	CW g	Action	Closed L. cm	Sect.	Guides	Weight g
11185-330	11.0	40	progressive	171	2+3	15	150
11185-360	12.0	50	progressive	128	3+3	15	185

Art.-No.	Length ft	CW g	Action	Closed L. cm	Sect.	Guides	Weight g
11185-390	13.6	120	medium fast	142	3+3	15	240

The Tournament S Feeder Art.-No.11185-390 is matching to the CT quivers with Art.-No. 11138- inside the N'Zon quiver range.



MEGATOP QUIVER TIPS

NEW

QUIVERTIPS

Art.-No.	Matching with Rod(s) Art.-No.	Material	Color	Type	TC oz
11999-107	11186-300, 11186-330, 11186-360, 11186-365, 11185-330, 11185-360	carbon fiber	white	ULQ	0.75
11999-110	11186-300, 11186-330, 11186-360, 11186-365, 11185-330, 11185-360	carbon fiber	orange	LQ	1.00
11999-115	11186-300, 11186-330, 11186-360, 11186-365, 11185-330, 11185-360	carbon fiber	yellow	MLQ	1.50
11999-116	11186-300, 11186-330, 11186-360, 11186-365, 11185-330, 11185-360	carbon fiber	red	MQ	2.00
11999-120	11186-300, 11186-330, 11186-360, 11186-365	carbon fiber	yellow	MLQ	1.50
11999-121	11186-300, 11186-330, 11186-360, 11186-365	carbon fiber	red	MQ	2.00
11999-130	11186-300, 11186-330, 11186-360, 11186-365	carbon fiber	fluo green	MHQ	3.00

TOURNAMENT SLR QUIVER TIPS

NEW

QUIVERTIPS

Art.-No.	Matching with Rod(s) Art.-No.	Material	Color	Type	TC oz
11999-015	11850-330, 11850-360, 11850-361, 11850-390, 11850-420	carbon fiber	orange	LQ	1.50
11999-020	11850-330, 11850-360, 11850-361, 11850-390, 11850-420	carbon fiber	white	MLQ	2.00
11999-025	11850-330, 11850-360, 11850-361, 11850-390, 11850-420	carbon fiber	green	MQ	2.50
11999-030	11850-330, 11850-360, 11850-361, 11850-390, 11850-420	carbon fiber	yellow	MHQ	3.00
11999-040	11850-330, 11850-360, 11850-361, 11850-390, 11850-420	carbon fiber	yellow white	HQ	4.00
11999-050	11850-330, 11850-360, 11850-361, 11850-390, 11850-420	carbon fiber	red	XHQ	5.00

The Tournament S Feeder Art.-No.11185-390 is matching to the CT quivers with Art.-No. 11138- inside the N'Zon quiver range.



AQUALITE FEEDER

Aqualite feeder rods definitively belong to the circle of most popular coarse fishing rods across the scene.

The cork/EVA handle section has been adopted towards the current requirements of modern feeder fishing and is pleasant to handle and easy to clean if required. The well-balanced blanks and the harmonized actions allow targeted and sensitive casts with tricky groundbait mixes and hookbaits at any time. Premium components like Fuji reel seats, lightweight guides with ceramic inlays and high-modulus carbon fiber at the blanks mark an astonishing configuration within this price segment.

The comprehensive lineup of the Aqualite Feeder series offers the fitting rod version for every field of application at modern feeder fishing.



- HMC+® carbon fiber blank
- High-quality cork / EVA grip
- Fuji® DPS screw-down reel seat
- Titanium oxide guides



11769-362

AQUALITE FEEDER

FEEDER ROD | CW -120G | -150G | -180G

Art.-No.	Length m	CW g	Action	Closed L. cm	Sect.	Guides	Weight g
11769-362	3.60	-120	medium fast	126	3+2	13	270
11769-392	3.90	-120	medium fast	137	3+2	13	295
11769-365	3.60	-150	medium fast	126	3+2	13	265
11769-395	3.90	-150	medium fast	136	3+2	13	300
11769-366	3.60	-180	medium fast	125	3+2	14	270
11769-396	3.90	-180	medium fast	135	3+2	14	285
11769-426	4.20	-180	medium fast	146	3+2	14	360

AQUALITE METHOD FEEDER

METHOD FEEDER ROD | CW -60G | -100G

Art.-No.	Length m	CW g	Action	Closed L. cm	Sect.	Guides	Weight g
11769-330	3.30	-60	semi-parabolic	116	3+2	13	185
11769-331	3.30	-100	semi-parabolic	170	2+2	13	205

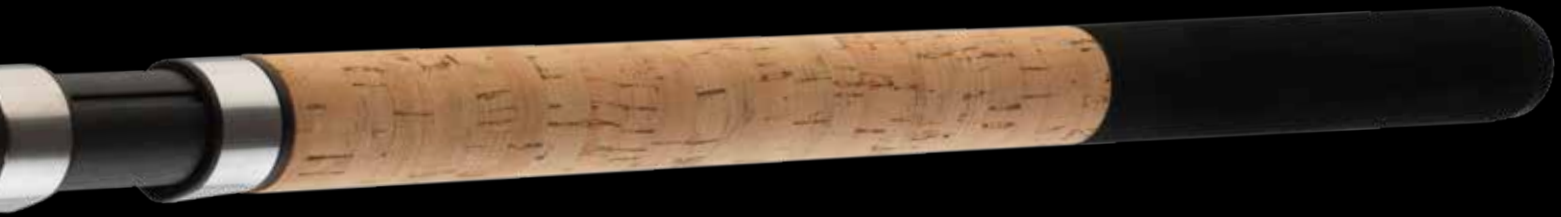

11769-396



11769-330

FEEDERTIPS FOR AQUALITE FEEDER

Art.-No.	Matching with Rod(s) Art.-No.	Matching with Rod(s) CW g	Color	Type	TC oz
11769-362R	11769-362	-120	red	HQ	3.00
11769-362Y	11769-362	-120	yellow	LQ	2.00
11769-392R	11769-392	-120	red	HQ	3.00
11769-392Y	11769-392	-120	yellow	LQ	2.00
11769-365R	11769-365	-150	red	HQ	4.00
11769-365Y	11769-365	-150	yellow	LQ	3.00
11769-395R	11769-395	-150	red	HQ	4.00
11769-395Y	11769-395	-150	yellow	LQ	3.00
11769-366R	11769-366	-180	red	HQ	5.00
11769-366Y	11769-366	-180	yellow	LQ	4.00
11769-396R	11769-396	-180	red	HQ	5.00
11769-396Y	11769-396	-180	yellow	LQ	4.00
11769-426R	11769-426	-180	red	HQ	5.00
11769-426Y	11769-426	-180	yellow	LQ	4.00

FEEDERTIPS FOR AQUALITE METHOD FEEDER

Art.-No.	Matching with Rod(s) Art.-No.	Matching with Rod(s) CW g	Color	Type	TC oz
11769-330R	11769-330	-60	red	HQ	3.00
11769-330Y	11769-330	-60	yellow	LQ	2.00
11769-331R	11769-331	-100	red	HQ	3.00
11769-331Y	11769-331	-100	yellow	LQ	2.00



忍 NINJA 者

- HMC+® carbon fiber blank
- Premium cork grip
- DPS reel seat
- Titanium oxide guides



NINJA X METHOD FEEDER

METHOD FEEDER ROD | CW -80G

The lightweight and slim blanks of the Ninja X Method feeder rods enable very long and targeted casts thanks to the fast resilience. Accurate casts are extremely important at method feeder fishing, since the rig has to be placed precisely at the feeding spot to achieve the perfect bite frequency. During the fight the blanks open up to a semi parabolic action – headbutts and rapid flights of large coarse fish and carps are perfectly absorbed and losses of fish and rigs are prevented reliably. One glass fiber tip and two carbon fiber tips offer the opportunity to quickly adapt to the very recent conditions at the water.

Art.-No.	Length m	CW g	Action	Closed L. cm	Sect.	Guides	Weight g
11610-331	3.30	80	fast	116	3+3	14	205
11610-361	3.60	80	fast	126	3+3	14	225

NINJA X STALKER FEEDER

STALKER FEEDER ROD | CW -100G

The Ninja X Stalker models are the perfect tool, when large feeders have to be applied in rough terrain and at the close range, where Picker rods reach their limits. Also a good choice for catching large baitfish from the boat at catfish and pike angling! The Ninja X Stalker Feeder is delivered with two carbon fiber quiver tips.

Art.-No.	Length m	CW g	Action	Closed L. cm	Sect.	Guides	Weight g
11611-240	2.40	100	fast	124	2+2	12	170
11611-270	2.70	100	fast	140	2+2	12	185

NINJA X FEEDER

FEEDER ROD | CW -120G | -150G | -220G

With the Ninja X feeder rods DAIWA offers a series of premium feeder rods at an outstanding price-performance ratio. Made of a slim and lightweight HMC+ carbon fiber blanks these well-balanced rods display a strong backbone – very long casts and great power reserves during the fight are the consequence. The Heavy and Extra Heavy feeder rods feature extra-large guides at the tips – perfect for using shock leaders. The rods with casting weights of up to 120g are designed for the application in silent water or at slow current and indicate even softest bites over long distances. Equipped with titanium oxide guides, two carbon fiber tips and one glass fiber tip, cork handle and cloth bag.

Art.-No.	Length m	CW g	Action	Closed L. cm	Sect.	Guides	Weight g
11608-330	3.30	120	fast	116	3+3	14	215
11608-360	3.60	120	fast	127	3+3	14	240
11608-390	3.90	120	fast	136	3+3	14	255
11608-365	3.60	150	fast	127	3+3	14	255
11608-395	3.90	150	fast	136	3+3	14	280
11608-366	3.60	220	fast	126	3+3	14	290
11608-396	3.90	220	fast	135	3+3	14	325



X FEEDER



FEEDERTIPS FOR NINJA X METHOD FEEDER

Art.-No.	Matching with Rod(s) Art.-No.	Matching with Rod(s) CW g	Color	Type	TC oz
11603-000R	11610-331, 11610-361	-80	red	HQ	3.00
11603-000G	11610-331, 11610-361	-80	green	MQ	2.00
11603-000Y	11610-331, 11610-361	-80	yellow	LQ	1.00

FEEDERTIPS FOR NINJA X STALKER FEEDER

Art.-No.	Matching with Rod(s) Art.-No.	Matching with Rod(s) CW g	Color	Type	TC oz
11605-240R	11611-240	-100	red	HQ	3.00
11605-240G	11611-240	-100	green	MQ	2.00
11605-270R	11611-270	-100	red	HQ	3.00
11605-270G	11611-270	-100	green	MQ	2.00

FEEDERTIPS FOR NINJA X FEEDER

Art.-No.	Matching with Rod(s) Art.-No.	Matching with Rod(s) CW g	Color	Type	TC oz
11605-001R	11608-330, 11608-360, 11608-390	-120	red	HQ	3.00
11605-001G	11608-330, 11608-360, 11608-390	-120	green	MQ	2.00
11605-001Y	11608-330, 11608-360, 11608-390	-120	yellow	LQ	1.00
11606-001R	11608-365, 11608-395	-150	red	HQ	4.00
11606-001G	11608-365, 11608-395	-150	green	MQ	3.00
11606-001Y	11608-365, 11608-395	-150	yellow	LQ	2.00
11607-365R	11608-366	-220	red	HQ	5.00
11607-365G	11608-366	-220	green	MQ	4.00
11607-365Y	11608-366	-220	yellow	LQ	3.00
11607-395R	11608-396	-220	red	HQ	5.00
11607-395G	11608-396	-220	green	MQ	4.00
11607-395Y	11608-396	-220	yellow	LQ	3.00



BLACK WIDOW FEEDER

The Black Widow Feeder series from DAIWA offers an extensive lineup of modern feeder rods at a sensational price-performance ratio.

The handle sections are covered with premium shrinktube and are extraordinarily pleasant to handle and can be cleaned easily once required. Equipped with titanium oxide guides. The Black Widow Feeder rods are delivered with one red and one yellow feeder tip.

- Carbon fiber blank
- EVA / shrinktube grip
- DPS reel seat
- Titanium oxide guides
- 2 quiver tips



BLACK WIDOW FEEDER

FEEDER ROD | CW -120G | -150G

The heavier rods with 120g and 150g casting weight and strong backbone feature larger guides at the quiver tips and therefore enable the easy-going application of shock leaders. Perfect when larger amounts of groundbait have to be applied at remote spots.

Art.-No.	Length m	CW g	Action	Closed L. cm	Sect.	Guides	Weight g
11789-361	3.60	-120	medium fast	127	3+2	15	295
11789-365	3.60	-150	medium fast	125	3+2	15	300
11789-395	3.90	-150	medium fast	135	3+2	15	330

BLACK WIDOW METHOD FEEDER

METHOD FEEDER ROD | CW -60G | -80G | -100G

The light feeder rods with 60g, 80g and 100g casting weight are tuned for the special requirements of modern feeder fishing.

Art.-No.	Length m	CW g	Action	Closed L. cm	Sect.	Guides	Weight g
11789-335	3.30	-60	semi-parabolic	117	3+2	14	240
11789-275	2.70	-80	semi-parabolic	96	3+2	13	195
11789-305	3.00	-80	semi-parabolic	106	3+2	14	215
11789-336	3.30	-100	semi-parabolic	116	3+2	14	250



BLACK WIDOW



11789-275

FEEDERTIPS FOR BLACK WIDOW FEEDER

Art.-No.	Matching with Rod(s) Art.-No.	Matching with Rod(s) CW g	Color	Type	TC oz
11789-361R	11789-361	-120	red	HQ	3.00
11789-361Y	11789-361	-120	yellow	LQ	2.00
11789-003R	11789-365, 11789-395	-150	red	HQ	4.00
11789-003Y	11789-365, 11789-395	-150	yellow	LQ	3.00

FEEDERTIPS FOR BLACK WIDOW METHOD FEEDER

Art.-No.	Matching with Rod(s) Art.-No.	Matching with Rod(s) CW g	Color	Type	TC oz
11789-002R	11789-275, 11789-305	-80	red	HQ	3.00
11789-002Y	11789-275, 11789-305	-80	yellow	LQ	2.00
11789-335R	11789-335	-60	red	HQ	3.00
11789-335Y	11789-335	-60	yellow	LQ	2.00
11789-336R	11789-336	-100	red	HQ	3.00
11789-336Y	11789-336	-100	yellow	LQ	2.00



- Carbon fiber blank
- Ergonomic grip design
- DPS reel seat
- Aluminum oxide guides

TRIFORCE



TRIFORCE TARGET FEEDER

NEW

FEEDER ROD | ML-XH

With the Triforce Target Feeder series, DAIWA offers a range of well-balanced and economic priced feeder rods in a modern design at an excellent price-performance ratio.

The powerful and slim blanks are well balanced and provide good casting and fighting characteristics. The lineup offers the right rod for almost every type of feeder fishing. The Method Feeder models are designed with a slightly more parabolic action – ideal to cope with the fast runs from carp or large bream on a short leader. The action of the Distance models has been optimized for use on large lakes and slow-flowing canals and also casts precisely to spots on distance. With the two Power Feeder rods with extra-large quiver guides, you can fish successfully in hard currents and with very heavy feeders. The use of coils is no problem. With the powerful 180g blanks of the Carp Feeder rods, catching a fish well over 20 pounds will make no trouble.

The carbon fiber blanks feature high-quality aluminium-oxide guides, DPS reel seats and an easy-to-clean EVA handle section.

Art.-No.	Length m	CW g	Action	Closed L. cm	Sect.	Guides	Weight g
11770-300	3.00	60	progressive	107	3+2	14	190
11770-330	3.30	80	progressive	117	3+2	14	230
11770-360	3.60	120	medium fast	128	3+2	14	265
11770-390	3.90	120	medium fast	138	3+2	14	295
11770-365	3.60	150	medium fast	128	3+2	14	280
11770-395	3.90	150	medium fast	138	3+2	14	310
11770-366	3.60	180	medium fast	128	3+2	14	290
11770-396	3.90	180	medium fast	138	3+2	14	320

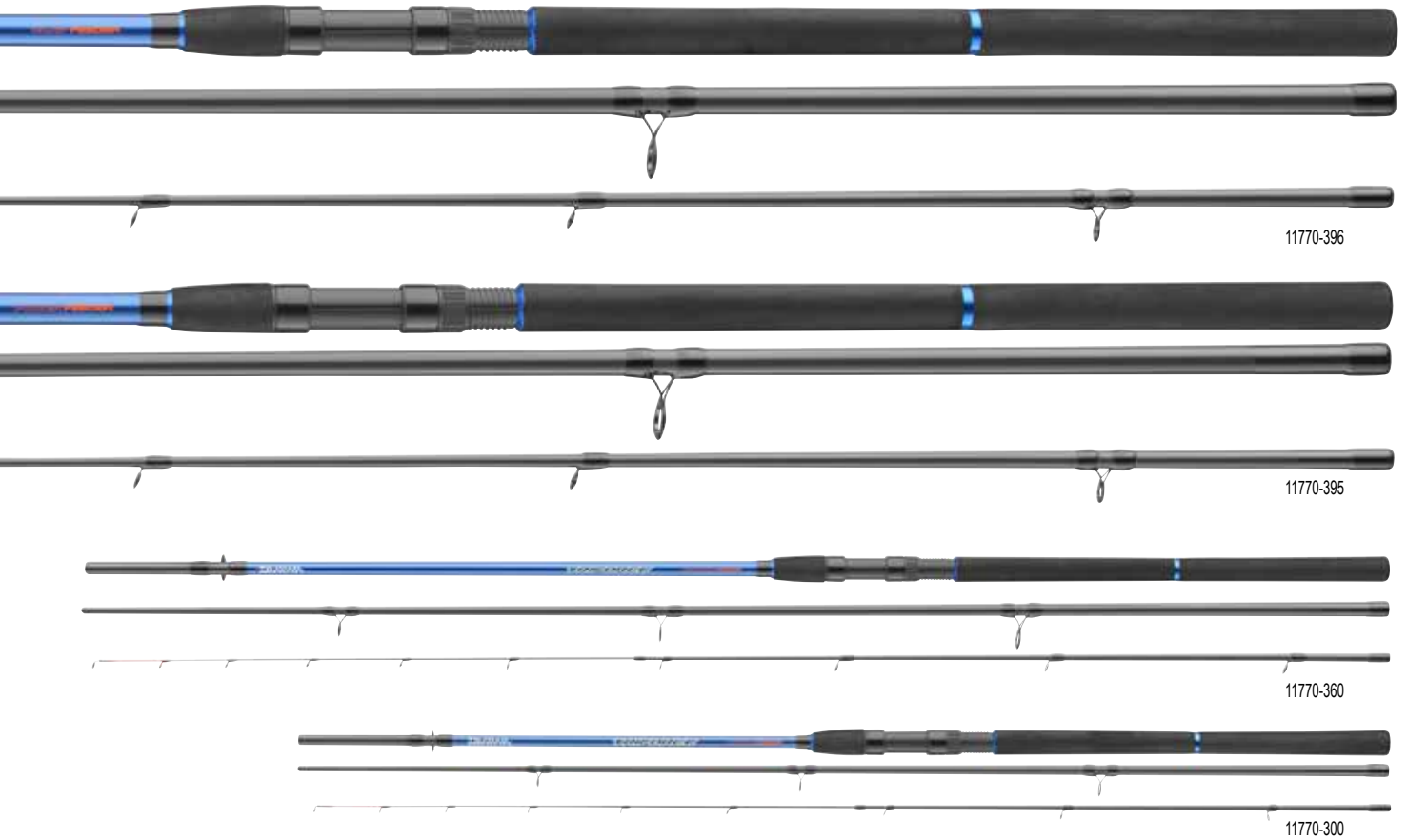

QUIVERTIPS FOR TRIFORCE TARGET FEEDER

NEW

Art.-No.	Matching with Rod(s) Art.-No.	Material	Color	Type	TC Oz
11770-300Y	11770-300	full carbon fiber	yellow	LQ	1.50
11770-300R	11770-300	full carbon fiber	red	MQ	2.00
11770-330Y	11770-330	full carbon fiber	yellow	MQ	2.00
11770-330R	11770-330	full carbon fiber	red	MHQ	3.00
11770-365Y	11770-365, 11770-395	full carbon fiber	yellow	MHQ	2.50
11770-365R	11770-365, 11770-395	full carbon fiber	red	HQ	3.50
11770-360Y	11770-360, 11770-390	full carbon fiber	yellow	MQ	2.00
11770-360R	11770-360, 11770-390	full carbon fiber	red	MHQ	3.00
11770-366Y	11770-366, 11770-396	full carbon fiber	yellow	HQ	3.50
11770-366R	11770-366, 11770-396	full carbon fiber	red	XHQ	4.00





BLACK WIDOW

- Carbon fiber blank
- Premium EVA / shrinktube grip
- DPS reel seat
- Titanium oxide guides
- 2 carbon fiber quiver tips



11574-305



BLACK WIDOW TELE FEEDER

TELE FEEDER ROD | CW -80G | -100G | -120G | -150G

Always the fitting rod!

The range of telescopic Black Widow feeder rods includes fitting rods for light fishing with method feeders as well as models for fishing with heavy feeders over great distances. The Black Widow Tele feeder rods can also be perfectly applied at fishing for eel! Despite their short sections, the blanks feature a smooth action and even bending curve.

Equipped with two carbon fiber feeder tips, EVA handle and titanium oxide double leg guides.

Art.-No.	Length m	CW g	Action	Closed L. cm	Sect.	Guides	Weight g
11574-305	3.00	-80	semi-parabolic	89	6+2	8	265
11574-335	3.30	-100	semi-parabolic	90	6+2	8	285
11574-365	3.60	-120	semi-parabolic	90	6+2	8	320
11574-395	3.90	-150	semi-parabolic	92	7+2	9	395

FEEDERTIPS FOR BLACK WIDOW TELE FEEDER

Art.-No.	Matching with Rod(s) Art.-No.	Matching with Rod(s) CW g	Color	Type	TC oz
11574-001R	11574-305	-80	red	HQ	3.00
11574-001Y	11574-305	-80	yellow	LQ	2.00
11574-002R	11574-335	-100	red	HQ	4.00
11574-002Y	11574-335	-100	yellow	LQ	3.00
11574-003R	11574-365, 11574-395	-120/150	red	HQ	5.00
11574-003Y	11574-365, 11574-395	-120/150	yellow	LQ	4.00

AQUALITE FLOAT & MATCH

AQUALITE

Classic beauties, convincing application.

The DAIWA Aqualite rods convince by a very slim blank diameter, ideal balance and high-quality components. By implementing the adjustable Armlock reel seat at the Sensor Float and Power Float models, the reel position can be perfectly adjusted to the individual requirements, resulting in an improved rod balance. The casting performance and the action of these rods is exquisite and perfectly designed for fishing with natural baits.

- HMC+® carbon fiber blank
- Cork / EVA grip
- Titanium oxide guides



AQUALITE POWER MATCH

MATCH ROD | CW -30G

Classical match rods with narrow guide arrangement and first-class workmanship. Ideally suited when heavy wagglers are used for fishing over great distances. The powerful Aqualite Match rods additionally provide enough backbone to net even big breams and medium-sized carps.

Equipped with classic screw-down reel seat.

Art.-No.	Length m	CW g	Action	Closed L. cm	Sect.	Guides	Weight g
11400-390	3.90	7-30	semi-parabolic	135	3	13	235
11400-420	4.20	7-30	semi-parabolic	145	3	14	265

AQUALITE SENSOR FLOAT

FLOAT ROD | CW -35G

With these light rods for fishing with the float every fight promises pure delight. The lightweight semi-parabolic blank opens up till the handle under strain and absorbs flights easily. Thanks to the soft tip section with spliced-in solid carbon fiber tip and the strong backbone these rods are also very well applicable for fishing for trouts with the sbirolino. The Aqualite Sensor Float is the ideal rod for fishing for tench, bream, trout and smaller carps but also are also well established at fishing for coregones with the float for years.

Equipped with customized Armlock cork handle for highest comfort during fishing.

Art.-No.	Length m	CW g	Action	Closed L. cm	Sect.	Guides	Weight g
11401-360	3.60	10-35	semi-parabolic	125	3	9	235
11401-390	3.90	10-35	semi-parabolic	135	3	9	240
11401-420	4.20	10-35	semi-parabolic	145	3	9	250



AQUALITE



AQUALITE POWER FLOAT

FLOAT ROD | CW -50G

The Aqualite Power Float rods with slim blanks and high resilience feature a strong backbone. Ideal for fishing with heavy pole floats and wagglers. The size of the guides is chosen to let the line stopper slide through the guides without problems. The fast and lightweight blank perfectly loads at casting and thus ensures long casting distances – also perfect for fishing for zander with natural bait.

Equipped with customized Armlock cork handle for highest comfort during fishing.

Art.-No.	Length m	CW g	Action	Closed L. cm	Sect.	Guides	Weight g
11402-360	3.60	15-50	semi-parabolic	126	3	9	225
11402-390	3.90	15-50	semi-parabolic	136	3	9	245
11402-420	4.20	15-50	semi-parabolic	146	3	9	255

AQUALITE TELE SENSOR FLOAT

TELE FLOAT ROD | CW -35G

The semi-parabolic Aqualite Tele Sensor Float rods are ideally suited for fishing for tench, bream and other cyprinid species with the float and additionally can be stowed and transported conveniently.

The soft tip excellently absorbs all flights and is matched with the action of the backbone, leading to a homogenic bending curve and a great casting performance.

Art.-No.	Length m	CW g	Action	Closed L. cm	Sect.	Guides	Weight g
11403-390	3.90	10-35	semi-parabolic	116	4	8	230
11403-450	4.50	10-35	semi-parabolic	131	4	8	245



BALLISTIC X

HVF

X45

AIRSENSOR

- HVF carbon fiber blank
- X45 carbon fiber construction
- Cork / EVA grip
- DAIWA Air Sensor reel seat
- Solid carbon fiber tip
- Seaguide Zirconia guides
- Screwable butt cap



11411-245



11411-270



11411-306



11411-201

BALLISTIC X TELE SPIN

TELE SPINNING ROD | L-XH

HVF carbon fiber, X45 technology at the blank, lightweight Seaguide guides with super-slim ceramic Zirconia inlays and the exclusive DAIWA Air Sensor reel seat are the reasons why the Ballistic X Tele rods are really exceptional within this rod category!

Due to the X45 carbon fiber design the single HVF segments are extremely lightweight, highly distortion-proof and fast – leading to perfectly balanced rods. The feeling with these rods is hard to distinguish from the one of premium detachable rods. The Ballistic X Tele spinning rods allow extraordinarily precise casts and transmit contact to the ground, lure action and softest taps instantly to the fisherman. The exclusive DAIWA Air Sensor reel seat is pleasant to handle, highly twist-resistant and supports the perfect transmission from the blank to the angler. The premium cork handle provides these classically designed rods with a special look.

The comprehensive lineup of the Ballistic X Tele series offers the proper model for almost every domestic predator species and most types or artificial lures.

Also for fishing with natural baits and fishing over very long distances the rods with 3.00m, 3.30m and 3.60m perform flawlessly!

Art.-No.	Length m	CW g	Action	Closed L. cm	Sect.	Guides	Weight g
11411-190	1.90	4-15	fast	57	6	5	100
11411-201	2.10	7-21	fast	59	6	5	110
11411-210	2.10	8-35	fast	59	6	5	115
11411-240	2.40	8-35	fast	66	7	6	145
11411-270	2.70	8-35	fast	68	7	6	155
11411-300	3.00	10-40	medium fast	72	8	7	165
11411-245	2.40	15-50	fast	66	7	6	150
11411-275	2.70	15-50	fast	69	7	6	160
11411-276	2.70	30-70	fast	71	7	6	165
11411-305	3.30	30-70	medium fast	82	8	7	190
11411-306	3.60	40-110	medium fast	87	8	7	200



- Carbon fiber blank
- Premium cork grip
- DPS reel seat
- Full carbon fiber tip
- Seaguide® titanium oxide guides
- Screwable butt cap



NINJA X TELE SPIN

TELE SPINNING ROD | L-H

With the Ninja X Tele rods DAIWA offers a broad range of versatile short-sectioned telescopic rods. With their premium carbon fiber blanks and the wrapped guides, the rods from the Ninja X Tele series display an action close to the one of detachable rods – fast actions with quick resilience allow precise casts and a good lure control at spin fishing. The solid carbon fiber tips are extremely tough and perfectly align with the harmonic action of the blanks.

These telescopic rods enable you to experience a lure control at spin fishing, that is hard to distinguish from a detachable rod.

The strong backbone with tip action reliable absorbs headbutts of large specimen and provides security at the fight. Of course, the Ninja X Tele is also very well suited for coarse angling using float or sinkers for almost all domestic freshwater species.

With the Ninja X Tele rods, you receive well-balanced light and premium telescopic rods for a sensational price.

Art.-No.	Length m	CW g	Action	Closed L. cm	Sect.	Guides	Weight g
11638-210	2.10	5-20	fast	63	6	5	130
11638-240	2.40	10-30	fast	68	7	6	155
11638-241	2.40	15-45	fast	68	7	6	160
11638-242	2.40	20-60	fast	71	7	6	165
11638-270	2.70	10-30	fast	71	7	6	170
11638-271	2.70	15-45	fast	71	7	6	175
11638-272	2.70	20-60	fast	73	7	6	180
11638-273	2.70	50-100	fast	74	7	6	195
11638-300	3.00	15-45	fast	73	7	6	200
11638-301	3.00	20-60	fast	76	7	6	210
11638-302	3.00	50-100	fast	76	7	6	215
11638-330	3.30	50-100	fast	81	8	7	265
11638-360	3.60	20-60	fast	85	8	7	270
11638-361	3.60	50-100	fast	85	8	7	275



HIGH MODULUS CARBON PLUS

- HMC+® carbon fiber blank
- Brading-X handle section
- Cork grip with EVA finish
- DPS reel seat
- Titanium oxide guides
- Screwable butt cap

MEGAFORCE TELE

MEGAFORCE

MEGAFORCE TELE

TELE ALL-ROUND ROD | L-XXXH

The Megaforce Tele rods are the proven choice for the application of long spinning rods with a compact closed length.

The Megaforce tele rods with up to 3.00m lengths display a closed length of only 58cm to 69cm and thus can be transported and stored conveniently. At the water these rods are quickly set-up and ready for action.

The models from 3.30m to 4.20m have been designed with longer sections, to maintain a good bending curve and casting performance also at these long rods.

The premium HMC+ carbon fiber blank of the Megaforce Tele is equipped with lightweight ceramic titanium oxide guides, which are both applicable for braided and monofilament lines. The proven DPS reel seat reliable severs fishing reels of all sizes and together with the cork handle provides these rods with a classic and respectable overall impression.

The lineup of this rod series offers the proper model for almost every purpose at fishing – and comes at a very good price-performance ratio.

Art.-No.	Length m	CW g	Action	Closed L. cm	Sect.	Guides	Weight g
11254-240	2.40	7-25	medium fast	63	6	5	150
11254-210	2.10	10-40	medium fast	58	5	4	135
11254-241	2.40	10-40	medium fast	63	6	5	160
11254-270	2.70	10-40	medium fast	67	6	5	195
11254-300	3.00	10-40	medium fast	68	7	6	210
11254-330	3.30	10-40	medium fast	103	6	6	255
11254-360	3.60	10-40	medium fast	103	6	6	265
11254-390	3.90	10-40	medium fast	105	7	7	350
11254-420	4.20	10-40	medium fast	105	7	7	360
11254-242	2.40	20-60	medium fast	65	6	5	195
11254-271	2.70	20-60	medium fast	67	6	5	205
11254-301	3.00	20-60	medium fast	68	7	6	260
11254-331	3.30	20-60	medium fast	104	6	6	270
11254-361	3.60	20-60	medium fast	114	6	6	280
11254-243	2.40	40-90	medium fast	65	6	5	200
11254-272	2.70	40-90	medium fast	67	6	5	225
11254-302	3.00	40-90	medium fast	69	7	6	260
11254-332	3.30	40-90	medium fast	104	6	6	275
11254-362	3.60	40-90	medium fast	114	6	6	285
11254-391	3.90	40-90	medium fast	115	7	7	355
11254-303	3.00	70-150	medium fast	69	7	6	290
11254-363	3.60	70-150	medium fast	106	6	6	340
11254-392	3.90	70-150	medium fast	107	7	7	405
11254-364	3.60	100-300	medium fast	106	6	6	360



MEGAFORCE T E L E



11254-241



11254-302



11254-361



11254-392



SWEEPFIRE TELE

The range of Sweepfire telescopic rods offers a perfect rod for nearly all kind of fishing for predators and coarse fishing.

- Composite blank
- Cork grip
- DPS reel seat
- Titanium oxide guides



11421-211



11421-241



11421-302

SWEEPFIRE TELE SPIN

TELE SPINNING ROD | UL-H

The Sweepfire Tele Spin series offers fitting rods for fishing at the stream, river, pond and lake. Due to the range from 1.90m to 3.00m, you will always find the perfect rod to fish successfully for trout, perch, pike and zander as well as bream, carp and eel. Ideal for beginners but also experienced anglers, who value compact pack sizes.

Art.-No.	Length m	CW g	Action	Closed L. cm	Sect.	Guides	Weight g
11421-190	1.90	3-15	medium fast	50	5	4	110
11421-210	2.10	5-20	medium fast	54	6	5	130
11421-240	2.40	5-20	medium fast	60	6	5	140
11421-211	2.10	10-30	medium fast	54	6	5	135
11421-241	2.40	10-30	medium fast	60	6	5	150
11421-270	2.70	10-30	medium fast	63	7	6	175
11421-300	3.00	10-30	medium fast	65	7	6	190
11421-242	2.40	15-50	medium fast	60	6	5	160
11421-271	2.70	20-60	medium fast	63	7	6	180
11421-301	3.00	30-60	medium fast	65	7	6	205
11421-243	2.40	30-70	medium fast	60	6	5	180
11421-244	2.40	40-90	medium fast	60	6	5	190
11421-272	2.70	40-90	medium fast	63	7	6	210
11421-302	3.00	40-90	medium fast	65	7	6	225



SWEEPFIRE



11421-211



11421-390

SWEEPFIRE TELE FLOAT

TELE FLOAT ROD | ML

Both Tele Float models within the Sweepfire series are marked by a distinct tip action and cast float rigs over great distances.

Art.-No.	Length m	CW g	Action	Closed L. cm	Sect.	Guides	Weight g
11421-360	3.60	10-45	progressive	74	8	7	250
11421-390	3.90	10-45	progressive	74	8	7	265



LEGALIS



HIGH MODULUS CARBON PLUS

- HMC+® carbon fiber blank
- Cork / EVA grip
- CNC-machined aluminum reel seat
- Titanium oxide double leg guides
- Screwable butt cap



11761-277



11761-308

LEGALIS TELE ALLROUND

TELE ALL-ROUND ROD | ML-H

The Legalis Tele series comprises a great selection of short-sectioned tele rods. With a closed length of only 75 to 87cm these rods can easily be stored in a fishing bag or be transported in a car or by bike.

The comprehensive lineup of this series contains rods, that can be applied for both spin fishing for trout, perch and pike as well as for coarse fishing for almost every domestic coarse fish species.

The semi-parabolic HMC+ carbon fiber blank of the Legalis Tele rods perfectly loads during the cast and allows enormous casting distances with rigs and lures. During the fight with the fish the harmonic bending curve prevents losses.

Equipped with titanium oxide tele guides, CNC-cut aluminum reel seat and ergonomically designed cork/EVA handle.

Art.-No.	Length m	CW g	Action	Closed L. cm	Sect.	Guides	Weight g
11761-246	2.40	10-50	medium fast	75	5	5	170
11761-276	2.70	10-50	medium fast	79	6	5	195
11761-306	3.00	10-50	medium fast	82	6	5	215
11761-336	3.30	10-50	medium fast	83	6	5	240
11761-366	3.60	10-50	medium fast	87	6	5	275
11761-277	2.70	30-90	medium fast	79	6	5	215
11761-307	3.00	30-90	medium fast	82	6	5	225
11761-337	3.30	30-90	medium fast	83	6	5	250
11761-367	3.60	30-90	medium fast	87	6	5	280
11761-308	3.00	40-120	medium fast	82	6	5	235
11761-368	3.60	40-120	medium fast	87	6	5	295





SALTIGA

MADE IN FIELD

- HVF® carbon fiber blank
- X45® carbon fiber construction
- V-Joint® put-over joint
- Hard EVA grip
- Fuji® DPS reel seat with double nut
- Fuji® SiC K-double leg guides
- Double wrapped guides
- Pacbay buttcap
- Semi-hard transportation holdall



11500-225

HVF



11500-255



SALTIGA AIR PORTABLE

TRAVEL SEA SPINNING ROD | HXH | XH | XXH

The multi-sectioned DAIWA Saltiga AP rods are designed for uncompromising application under harshest conditions in tropical destinations. Closed lengths of 67cm to 78cm allow a straightforward transport in the luggage – expensive rod transportation tubes from now on belong to the past.

The lineup of the Saltiga Air Portable series offers a small assortment for the uncompromising application in the tropics and other big fish destinations.

To ensure safe fishing for strong fighting target fishes like GT, Tuna, Cubera, Amberjack, Rooster & Co., the rod blank, reel seat, guides and spigot joints have to be of utmost high quality. HVF carbon fiber blanks with X45 technology are extremely durable and twist resistant – accurate casts and controlled lure presentation are possible every time.

The backbone of the Saltiga rods offers huge power reserves to control large specimen during the fight and to lead them away from hazardous areas and reefs with completely closed drag. The tip action accelerates hardbaits to very good casting distances. Underwrapped Fuji SiC double leg K-guides resist even toughest strains. The V-Joint spigot joint connections are reinforced with a special BIAS carbon fiber material which leads to incredibly robust joints with a perfectly harmonic bending curve. The difference to a two-sectioned rod is hard to detect!

Original Fuji reel seats with double screw secure heavy spinning reels permanently and prevent a loosening of the reel during the fight. Ergonomically shaped Hard-EVA handles are pleasant to grab, offer an optimal power transmission and prevent too quick exhaustion during fishing. The three-sectioned model with a length of 1.70m has been developed for speed jigging in medium to large depths. The extremely stiff blank with a casting weight of 180-400g is perfectly balanced and offers huge power reserves for the fight.

Depending on the model these rods are also very well suited for fishing in Norway for cod, coalfish and halibut!

Art.-No.	Length m	CW g	Action	Closed L. cm	Sect.	Guides	Weight g
11500-245	2.40	50-120	extra fast / fast	72	4	7	380
11500-255	2.55	50-160	extra fast / fast	74	4	7	415
11500-225	2.25	60-165	extra fast / fast	67	4	7	395
11500-175	1.70	180-400	extra fast / fast	78	3	6	365



Sevally
Fish Fighters



11500-175



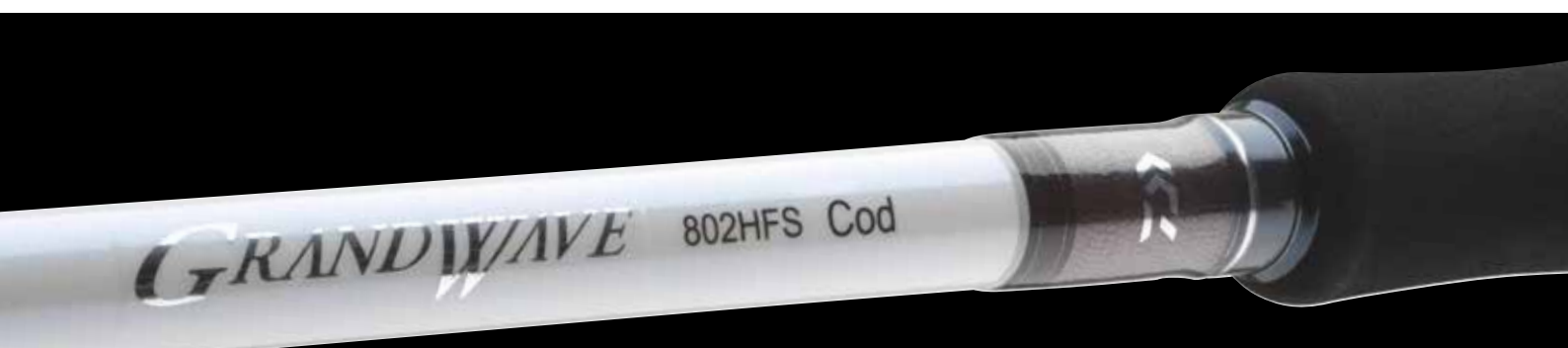

GRANDWAVE SEA

- HVF® carbon fiber blank
- Premium EVA grip
- Fuji® reel seat
- Fuji® Alconite K-guides

With the rods from the Grandwave series DAIWA offers perfect special rods for the experienced sea fisherman to target the most popular target fish in the Baltic and North Sea as well as in Norway. Together with our team angler and cameraman Arne Seiberlich, an extraordinary series of premium special rods has been created that has already been intensely tested. Exclusive DAIWA technology at the blanks and premium components and processing quality guarantee highest reliability and performance.

HVF



GRANDWAVE POLLOCK

JIGGER ROD | M

The Grandwave Pollock with a casting weight of 40-100g offers ultimate fighting fun with coalfish and pollack with both pirks and shads. The blank perfectly absorbs flights and reduces losses during the fight with the fish.

Art.-No.	Length m	CW g	Action	Closed L. cm	Sect.	Guides	Weight g
11882-245	2.40	40-100	extra fast / fast	126	2	8	230

GRANDWAVE COD

JIGGER ROD | H

The Grandwave Cod allows the application of large shads, heavy pirks and natural bait rigs. This rod is easily capable of fighting cods beyond 20kg or taming halibuts at the D-Wolf. With a length of 2.40m fishing over distance is not a problem and also the handling at the boat is conveniently possible.

Art.-No.	Length m	CW g	Action	Closed L. cm	Sect.	Guides	Weight g
11882-246	2.40	150-300	extra fast / fast	126	2	8	245



GRANDWAVE



GRANDWAVE HALIBUT

BOAT ROD | H

The Halibut and Power Halibut rods have been developed for the supreme discipline at the Norwegian Sea. The halibut doubtlessly belongs to the most powerful opponents, requiring everything from the angler and the gear during the fight. Good to have reliable and tough tackle in your hands at this moment.

The two Grandwave Halibut rods have been exactly tailored for this uncompromising fishing and display optimal characteristics at lure presentation and during the fight. The model with 25lb is also a perfect choice for targeting large cods with the multiplier reel. The light parabolic action perfectly absorbs flights and reduces the threat of losses. The strong backbone at both models offers enough reserves to force even heavy specimen to the surface.

Art.-No.	Length m	TC lb	Action	Closed L. cm	Sect.	Guides	Weight g
11882-221	2.25	15-25	fast	119	2	8	275

GRANDWAVE POWER HALIBUT

BOAT ROD | XH

Art.-No.	Length m	TC lb	Action	Closed L. cm	Sect.	Guides	Weight g
11882-222	2.25	30-40	fast	119	2	8	290

GRANDWAVE TRAVEL

TRAVEL JIGGER ROD | M | H | XH

With the Travel models we offer short-sectioned travel rods that easily can be transported in your luggage. The 2.25m model is perfectly suited for casting large soft plastic shads for cod and halibut as well as for classic jigging. The 2.40m version can be both applied from the boat and the shore and offers highest fighting fun with cod, coalfish and pollack.

The 2.10m rod with a casting weight of up to 400g is the proper choice when heavy lures have to be applied at strong current or at great depths and very large specimen and halibut are the target.

Art.-No.	Length m	CW g	Action	Closed L. cm	Sect.	Guides	Weight g
11882-215	2.10	150-400	fast	58	4	8	225
11882-220	2.25	150-300	fast	63	4	8	230
11882-247	2.40	50-125	fast	66	4	8	215



DEEPDROP

LEOBRITZ

- Glatech® Construction Blank
- X45X® carbon fiber construction
- V-Joint® put-in joint
- Solid EVA grip
- ALPS® aluminum reel seat with double nut
- Fuji® Alconite K-guides
- Wrapped guides
- Fuji® gimbal butt cap

GLATECH
Construction

ALPS™



X45X
X45 FULL SHIELD



11807-215

LEOBRITZ DEEPDROP

NEW

BOAT ROD | CW 200-600G

The Leobritz Deepdrop made by DAIWA is the perfect combination with the small and powerful Leobritz 300 electric reel. The Deepdrop rod is specially designed for medium-heavy deep-sea fishing with up to 600g leads for redfish, lump and ling – but is also perfectly suitable for jiggging in the pelagic zone for large coalfish and cod.

The thin, very lightweight but powerful HVF carbon blank in the handle section in combination with the exclusive DAIWA Glatech technology in the tip section provides the perfect alliance of power and sensitivity. The blank is virtually unbreakable even under extreme fishing conditions and heavy loads from depth.

The sensitive tip indicates even fine and sensitive bites at great depths and thanks to the progressive, semi-parabolic action prevents losing fish once retrieving from great depths.

By the X45X technology, a layer of special carbon fibre has been applied to the blank surface at a 45-degree angle – this considerably improves compression and torque with heavy loads.

The original V-joint put-in connection allows the construction of outstanding thin and light weight tip sections that improve the balance and ensure a perfect bending curve. The use of Glatech material in the tip section ensures high elasticity and maximum resilience.

The original Fuji Alconite K guides reduce the risk of tangles and are another quality feature of this Deepdrop rod. Features an original ALPS aluminium reel seat with double screw-nut that firmly holds your reel.

The Leobritz Deepdrop is our recommendation when targeting redfish at depths of around 180m.

Art.-No.	Length m	CW g	Action	Closed L. cm	Sect.	Guides	Weight g
11807-215	2.15	200-600	medium fast	111	2	9	355



Tanacom

- HVF® carbon fiber blank
- V-Joint® put-in joint
- Solid EVA grip
- ALPS® aluminum reel seat with double nut
- ALPS® guides
- Wrapped guides
- Fuji® gimbal butt cap

HVF
ALPS™



11806-216



TANACOM ULTRA DEEP

NEW

DEEP SEA BOAT ROD | CW -1000G

The special rod for usage with electric reels – the name says it all!

With the Tanacom Ultra Deep you have the perfect tool for fishing at great depths between 150m and over 250m. The powerful HVF carbon fibre blank is suitable for weights up to 1000g. The sensitive, coloured tip also indicates fine bites at depth and reduces the risk of unhooking fish when retrieving. The ALPS guides, are specially designed for tough use on boats, have no inner rings and are therefore particularly suitable for this tough and uncompromising fishing. The high-quality, machined aluminium reel seat made by ALPS, firmly holds your heavy electric reel in place thanks to the additional double screw nut.

Art.-No.	Length m	CW g	Action	Closed L. cm	Sect.	Guides	Weight g
11806-216	2.10	400-1000	medium fast	110	2	9	470



SEALINE X'TREME INTERLINE

Numerous caught large specimens like halibuts over 300lbs and cods over 60lbs are the reason why the Sealine X'treme Interline series has become a legend among sea fishing rods.

Highest standards regarding workmanship and proven technologies like HVF carbon fiber, X45 technology and V-Joint spigot joints are the pillars of reliability and longevity even under harshest offshore fishing conditions.

- HVF® carbon fiber blank
- X45® carbon fiber construction
- V-Joint® put-in joint
- Shrinktube grip
- Original DAIWA® reel seat
- Screwable tip guide
- Gimbal butt cap

HVF

V-JOINT

X45

SEALINE

INTERLINE



11845-226



11845-225



SEALINE X'TREME INTERLINE LIGHT

INLINE JIGGER ROD | MH

With the Light models from the Sealine X'treme series DAIWA offers the proven Interline technology at blanks with modified actions that are designed for light jiggering and using shads. The Light Pilk models are especially suited for targeting cod and coalfish in shallow and medium depths with lures of up to 250g. The equally divided model can be transported in a convenient way and the four-sectioned Travel version with only 65cm closed length can be perfectly stowed when travelling by plane. Just like the established heavy models, also the Sealine Interline Light Pilk rods are perfectly reliable companions at sea fishing!

Art.-No.	Length m	CW g	Action	Closed L. cm	Sect.	Guides	Weight g
11845-225	2.25	100-250	medium fast	119	2	2	335
11845-226	2.25	100-250	medium fast	65	4	2	330



SEALINE



HVF



- HVF® carbon fiber blank
- X45® carbon fiber construction
- V-Joint® put-in joint
- Shrinktube grip
- Screwable tip guide
- Gimbal butt cap



SEALINE

— INTERLINE —

X'TREME | TRAVEL



11846-215



11846-235

SEALINE X'TREME INTERLINE

INLINE BOAT ROD | 15-30LB | 30-50LB

The Sealine Interline rod with 15-30lbs is the perfect choice for fishing for coalfish, cod and halibut with lighter tackle. Quick escapes are absorbed in a smooth manner and accidental unhooking is prevented effectively.

The 30-50lbs model covers the full range of heavy sea fishing with lures and natural bait for halibut, cod, ling and wolffisch. The sensitive tip indicates even softest bites reliably and the strong backbone allows to master also fights with 100kg giants!

In case of damage the tip sleeve can be replaced within seconds thanks to the special screw-in system.

Art.-No.	Length m	LC lb	Action	Closed L. cm	Sect.	Guides	Weight g
11845-235	2.35	15-30	medium fast	158	2	2	480
11845-236	2.35	30-50	medium fast	162	2	2	505



X'TREME



11845-236



11846-236



SEALINE X'TREME TRAVEL INTERLINE

TRAVEL INLINE BOAT ROD | 15-30LB | 30-40LB

The Sealine X'treme Interline Travel rods from DAIWA are especially popular among fishermen who seek their adventure in northern Norway. Due to the extraordinary action, which can hardly be distinguished from two-sectioned rods, these rods also have a huge fanbase among anglers who travel to more nearby fishing destinations by car or plane.

The lineup of these exclusively equipped travel rods features matching rods for most common fishing techniques for cod, coalfish and halibut as well as for deep sea fishing for redfish and ling.

The three-sectioned model with 30-40lbs is designed for using pirks between 100g and 300g as well as for XL shads up to 30cm and heavy jigheads. The soft tip buffers flights perfectly while the strong backbone offers enormous power reserves – large halibuts and cods can be directed without compromises!

The four-sectioned models fit in almost every suitcase and are ideally suited for fishing trips way up north by plane. The harmonic tip action reliably indicates bites and prevents unhooking during the fight. With the help of the powerful backbone also large sea predators like cod, coalfish and halibut can be controlled in a safe and determinate way. Fishing fun guaranteed at any time!

These rods are available with either an DAIWA screw-in reel seat or with an Fuji trigger reel seat (art.-no. 11846-236). The tip sleeves are screwed-in and can be replaced within seconds in the case of damage.

Art.-No.	Length m	LC lb	Action	Closed L. cm	Sect.	Guides	Weight g
11846-235	2.35	15-30	medium fast	65	4	2	355
11846-236	2.35	15-30	medium fast	65	4	2	325
11846-215	2.13	30-40	medium fast	77	3	2	410

SEALINE



SEALINE PILK

With the Sealine Pilk rods DAIWA offers a large range of modern sea fishing rods for fishing in the Baltic Sea and the North Sea as well as in Norway.

- HMC+® carbon fiber blank
- EVA / shrinktube grip
- Seaguide® XSS reel seat
- Seaguide® double leg guides
- Gimbal butt cap



SEALINE PILK

JIGGER ROD | MH | H | XH | XXH

Made of high-modulus carbon fiber these rods are equipped with innovative components and feature a great handling experience. The X-pattern shrinktube handle section cares for a perfect grip and can be easily cleaned if required. The EVA upper handle section has been chosen somewhat shorter and is directly mounted to the blank via a shrinktube. This arrangement allows optimal control during the fight with large sea predators. The tip action of the Sealine rods absorb headbutts and flights of hooked fishes perfectly while the stiff backbone offers enough power to control also large specimen during the fight. The reel seat from the Seaguide Alien concept is especially pleasant to grab due to its broad and closed shape and allows fatigue-free fishing for a long time. The saltwater-resistant Seaguide guides with Zirconia inlays easily withstand the extreme conditions at sea fishing and allow the use of both fixed spool and multiplier reels.

Equipped with rubber gimbal butt cap for a safe storage in the boat rod holder.

Art.-No.	Length m	CW g	Action	Closed L. cm	Sect.	Guides	Weight g
11350-210	2.10	40-100	medium fast	111	2	7	250
11350-270	2.70	40-100	medium fast	141	2	7	315
11350-240	2.40	80-200	medium fast	125	2	7	305
11350-275	2.70	80-200	medium fast	141	2	7	370
11350-245	2.40	150-300	medium fast	125	2	7	320
11350-215	2.10	150-300	medium fast	111	2	7	270
11350-225	2.25	200-500	medium fast	118	2	8	315



11350-215



11350-270



11351-245

SEALINE TRAVEL PILK

TRAVEL JIGGER ROD | H | XH

With a closed length of only 66cm the four-sectioned models of the Sealine Pilk series perfectly fit into the luggage. Thanks to the use of spigot ferrules the HMC+ blanks are very slim and especially lightweight at the same time. Additionally, the Sealine Travel Pilk rods display a bending curve, that is hard to distinguish from a two-sectioned rod. With a total length of 2.40m and castings weights of 200g or 300g these rods cover the most important fields of application for fishing with pirks or with large shads for cod, coalfish, pollack or light fishing for halibuts.

Equipped with rubber gimbal butt cap for a safe storage in the boat rod holder.

Art.-No.	Length m	CW g	Action	Closed L. cm	Sect.	Guides	Weight g
11351-240	2.40	80-200	medium fast	66	4	7	300
11351-245	2.40	150-300	medium fast	66	4	7	315

BG OFFSHORE

Matching with the BG reel series, DAIWA offers a comprehensive series of sea fishing rods for fishing in Norway, the Baltic Sea and the tropics.

The lineup of the BG series features rods for fishing for cod, coalfish and halibut with natural baits but comprises also models for surface fishing for Mahi Mahi and GT with stickbait and poppers. Also rods for jigging for Amberjack or deep sea fishing for Redfish belong to the BG range.

Of course, this range also offers travel rods with short sections for the most common sea fishing methods, especially for Norway.

The robust HMC+ blank is equipped with saltwater-proof titanium oxide guides, DPS-H or DPS reel seat with safety screw and a durable EVA handle. These features make the BG rods a reliable companion during uncompromising fishing trips to the oceans of the globe.



- HMC+® carbon fiber blank
- Thread wrapping
- Separated EVA grip
- Saltwater-proof titanium oxide guides

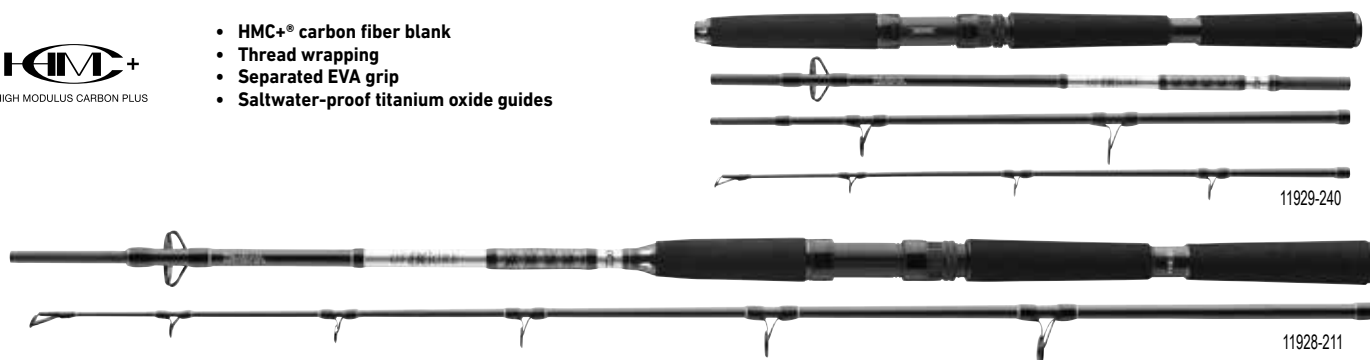

BG OFFSHORE PILK

JIGGER ROD | H | XH

Universally applicable jigging and shad rods, that can be applied from both the boat and from the shore.

The lighter models of the BG Offshore Pilk have been designed for inshore fishing for cod and coalfish in the Baltic and North Sea as well as in Norwegian Fjords.

Art.-No.	Length m	CW g	Action	Closed L. cm	Sect.	Guides	Weight g
11928-210	2.10	40-125	fast	109	2	7	235
11928-240	2.40	40-125	fast	124	2	7	265
11928-270	2.70	40-125	fast	141	2	7	300
11928-241	2.40	50-165	fast	126	2	7	255
11928-271	2.70	50-165	fast	141	2	7	270
11928-300	3.00	50-165	fast	156	2	7	285

BG OFFSHORE BOAT

BOAT ROD | XXH

The two BG Offshore Boat rods are ideally suited for active fishing for large cods, coalfish and halibut. Perfect, when large shads, baitfish or pirks should be used.

Art.-No.	Length m	CW g	Action	Closed L. cm	Sect.	Guides	Weight g
11928-211	2.10	150-400	medium fast	110	2	7	220
11928-242	2.40	150-400	medium fast	126	2	7	250

BG OFFSHORE TRAVEL

TRAVEL JIGGER ROD | H | XH | XXXH

Travel rods wit short sections, solid spigot joint and even bending curve. Made for most important target fish and fishing methods in Norway, North and Baltic Sea.

Art.-No.	Length m	CW g	Action	Closed L. cm	Sect.	Guides	Weight g
11929-225	2.25	150-500	fast	62	4	7	245
11929-240	2.40	40-125	fast	65	4	7	235
11929-241	2.40	50-200	fast	65	4	7	240
11929-270	2.70	50-200	fast	73	4	7	275



BG SEA JIGGER

SEA SPINNING ROD | XXH

For successful speed jigging with heavy metal jigs, rods with special characteristics and qualities are needed. This kind of fishing requires everything from your tackle – the used HMC+ blank in combination with the premium titanium oxide guides easily resists even toughest strains during powerful jigging and fast retrieving of heavy jigs. The very robust blank exactly provides the necessary characteristics to speed up the jig and to force powerful fish during the fight. Perfect companion for Amberjack!

Art.-No.	Length m	CW g	Action	Closed L. cm	Sect.	Guides	Weight g
11928-170	1.70	150-400	fast	108	1+1	6	265

BG POPPER

SEA SPINNING ROD | XH

The BG Popper has been developed for fishing with surface lures like big stickbaits and poppers. The somewhat softer tip in combination with the strong backbone, easily casts surface lures of 70-120g to great distances. The extra-large, saltwater-proof guides enable the usage of thick shock leaders and long leaders without any problems.

The BG Popper is also perfectly suited for heavy fishing for halibut with big softplastic lures in Norway!

Art.-No.	Length m	CW g	Action	Closed L. cm	Sect.	Guides	Weight g
11928-230	2.30	40-150	fast	120	2	7	330

BG DEEP SEA

BOAT ROD | XH | XXH

With the Deep Sea versions of the BG series, DAIWA offers outstanding reels for deep sea fishing for cod, halibut or redfish.

The guides and action of these extremely robust blanks, have been perfectly adjusted to the needs of different deep sea fishing techniques with natural bait and lures. Thanks to the long front handle section, you can optimally force the fight with the fish. The BG Deep Sea rod 11928-175 has a somewhat stiffer blank and thus perfectly matches with fishing in great depth with lures and pinks – ideal for cod, pollack and halibut.

To mount also very heavy multiplier reels securely, the Deep Sea versions have been equipped with a DPS-H reel seat and safety screw.

Art.-No.	Length m	CW g	LC lb	Action	Closed L. cm	Sect.	Guides	Weight g
11928-175	1.75	100-300	30	medium fast	114	1+1	7	305
11928-221	2.20	150-300	30	medium fast	116	2	9	350
11928-220	2.20	150-400	30-40	medium fast	115	2	9	380

BG



- Carbon composite blank
- Reliable put-in joint
- Solid EVA grip
- Heavy-duty reel seat
- Saltwater-proof titanium oxide guides
- Wrapped guides
- Aluminum gimbal butt cap



11929-165



11929-166



BG BIG GAME

NEW

BOAT ROD | 20-30LB | 30-50LB

The three-piece blanks of the 30lbs and 50lbs rods are the perfect choice for trips to the Caribbean and other tropical areas, the Mediterranean and the Adriatic sea. The powerful, extremely resilient blanks made of composite material have enough power to mess with those strong warm water fighters and specially designed to cope with smaller tuna and skipjacks, amberjack, mahi mahi, etc. The compact transport size of just 69cm allows easy transport and stowage in your normal luggage. No need for an expensive transport tube!

The 30-50lbs model features a roller tip guide. The softer 20-30lbs rod features a normal tip guide with ceramic ring. Both rods are featuring a high-quality, extremely durable and torque-resistant aluminium reel seat and a gimbal butt cap. With these BG Big Game Rods you are ready to fight the strongest saltwater predators.

Art.-No.	Length m	TC lb	Action	Closed L. cm	Sect.	Guides	Weight g
11929-165	1.68	20-30	progressive	69	3	7	520
11929-166	1.68	30-50	progressive	68	3	7	560



SEAHUNTER X

The diverse target fish rods of the Seahunter X series have been optimized for the respective field of application and the individual fishing methods. Superbly equipped with saltwater-proof Seaguide guides, HMC+ carbon fiber blanks, robust spigot joints and non-slip EVA handles the Seahunter X rods are available at an excellent price-performance ratio.

- HMC+® carbon fiber blank
- Spigot put over joint
- Premium EVA grip
- DPS reel seat
- Full carbon fiber tip, color-contrasted
- Seaguide® titanium oxide guides



SEAHUNTER X PILK HERRING

JIGGER ROD | M

The Herring model from the Seahunter X series features a somewhat softer tip and a heavy backbone. It reliably indicates bites and allows long casts with Herring rigs as well as lifting the catch easily to the boat or the bank.

Art.-No.	Length m	CW g	Action	Closed L. cm	Sect.	Guides	Weight g
11533-270	2.70	30-60	extra fast / fast	142	2	8	185

SEAHUNTER X PILK MACKEREL

JIGGER ROD | H

With the Mackerel rod even the fight with several fishes at the same time do not represent a problem. The blank offers enough power reserves to tame those powerful fishes and lift them on board easily.

Art.-No.	Length m	CW g	Action	Closed L. cm	Sect.	Guides	Weight g
11533-260	2.60	60-180	fast	134	2	8	235

SEAHUNTER X PILK COALFISH

JIGGER ROD | H

The two coalfish rods are ideally suited for the use of shads or smaller pirks and offer huge fighting fun. The harmonic action of the rods reliably prevents unhooking during the fight and allows good casting distances at fishing from the boat and the shore.

Art.-No.	Length m	CW g	Action	Closed L. cm	Sect.	Guides	Weight g
11533-245	2.40	40-120	fast	127	2	6	200
11533-275	2.70	40-120	fast	140	2	6	230



SEAHUNTER X PILK COD

JIGGER ROD | XH

The two cod models with strong tip action and power-backbone seductively accelerate shads and pirks and don't give in even when fighting extra-large opponents! The Seahunter X Pilk Cod are reliable companions on the German seas as well as at the Scandinavian inshore waters.

Art.-No.	Length m	CW g	Action	Closed L. cm	Sect.	Guides	Weight g
11533-246	2.40	100-200	fast	124	2	6	215
11533-276	2.70	100-200	fast	140	2	6	250

SEAHUNTER X SEA TROUT

SEA TROUT ROD | ML

The Seahunter X Sea Trout is the perfect rod for targeting sea trouts at the German Baltic Sea and the Scandinavian inshore territories. The slim lightweight blank features a pleasant handling and offers enough power reserves to net also large specimen. Thanks to the semi-parabolic action of the HMC+ blank the rod fully loads at casting and catapults spoons and plugs reliably to long distances. Rapid flights are absorbed perfectly. Equipped with a genuine spigot joint.

Art.-No.	Length m	CW g	Action	Closed L. cm	Sect.	Guides	Weight g
11533-312	3.10	10-40	medium fast	160	2	9	185

SEAHUNTER X TELE SURF

SURF ROD | MH

The Seahunter X Tele Surf is ready-to-use within seconds and reliably catapults sinkers of up to 180g to long distances. The slim HMC+ carbon fiber blank fully loads during the cast and indicates also soft bites highly accurate. Equipped with premium saltwater-proof Seaguide guides and X-pattern shrinktube handle.

Art.-No.	Length m	CW g	Action	Closed L. cm	Sect.	Guides	Weight g
11535-395	3.90	60-180	medium fast	146	6	6	420



SEA HUNTER

- HMC+® carbon fiber blank
- Reliable put-in joint
- Shrinktube grip
- DPS reel seat
- Saltwater-proof titanium oxide guides

SURF CASTING
POWER CASTING PERFORMANCE



HIGH MODULUS CARBON PLUS



SEAHUNTER X SURF

NEW

SURF ROD | H

The Seahunter X Surf rods please with their fast and powerful blanks with thin diameters. The lightweight HMC+ carbon blanks perfectly load up during the cast and easily cope with heavy surf rigs and provide outstanding casting distances. A high-quality shrink tube at the end of the handle ensures a firm grip and comfortable handling during casting. The night-glow tip is slightly softer and even indicates sensitive bites in poor weather conditions and in the darkness. Features Titanium oxide guides and a robust DPS reel seat.

Art.-No.	Length m	CW g	Action	Closed L. cm	Sect.	Guides	Weight g
11535-390	3.90	100-250	progressive	136	3	7	455
11535-420	4.20	100-250	progressive	147	3	7	525
11535-450	4.50	100-250	progressive	157	3	7	610



HIGH MODULUS CARBON PLUS

- HMC+® carbon fiber blank
- Reliable put-in joint
- Ergonomic grip design
- Screw-down reel seat
- Saltwater-proof titanium oxide guides



WINDCAST SURF

SURF ROD | CW -200G

Slim blank and strong backbone – made for long casts!

The Windcast Surf has especially been developed for fishing in the Baltic or Northern Sea and combines a thin blank with a powerful backbone for maximum casting distances – the somewhat softer tip ensures an optimal bite indication.

The rod loads optimally over the whole blank with casting weights from 150g to 180g and enables you to reach great casting distances.

Art.-No.	Length m	CW g	Action	Closed L. cm	Sect.	Guides	Weight g
11808-420	4.20	100-200	medium fast	147	3	8	535



LINE PROGRAM 2025





BRAIDES LINES



- 12-Braid, round-braided
- Silicone surface coating
- 10m color marker
- Extremely high linear strength
- Extremely high wet knot strength
- Extremely high abrasion resistance
- Extremely low frictional resistance
- Made in Japan

12 BRAID

The DAIWA 12 Braids very likely belong to the most pristine braided lines currently available worldwide. These high-performance lines offer a hitherto unexperienced sensation at casting and fishing.

Thanks to the tight braid and the silicone coating at the surface, this line resembles a mono fishing line and easily glides through the guides with ultimate silence. The smooth surface reduces friction by up to 18% and ensures long casting distances.

By optimized manufacturing procedures and applying highest standards Japanese lines surpass the linear strength of other lines by up to 20% at the same diameter. Compared to conventional braids, the abrasion resistance is elevated by up to 72%.

MORETHAN 12 BRAID EX+SI

BRAIDED LINE | LIME GREEN

The 12 Morethan in lime green is available with 10m marker, allowing you to track your casting distance or fishing depth with ease.

Art.-No.	Color	Capacity m	Ø mm	Strength kg	Strength lb
12695-008	lime green	135	0.08	5.80	13.0
12695-010	lime green	135	0.10	7.30	16.0
12695-012	lime green	135	0.12	10.20	22.0
12695-014	lime green	135	0.14	12.20	27.0
12695-016	lime green	135	0.16	14.00	31.0
12695-018	lime green	135	0.18	16.20	36.0

Art.-No.	Color	Capacity m	Ø mm	Strength kg	Strength lb
12695-308	lime green	300	0.08	5.80	13.0
12695-310	lime green	300	0.10	7.30	16.0
12695-312	lime green	300	0.12	10.20	22.0
12695-314	lime green	300	0.14	12.20	27.0
12695-316	lime green	300	0.16	14.00	31.0
12695-318	lime green	300	0.18	16.20	36.0



SALTIGA 12 BRAID EX+SI

BRAIDED LINE | MULTI-COLOR

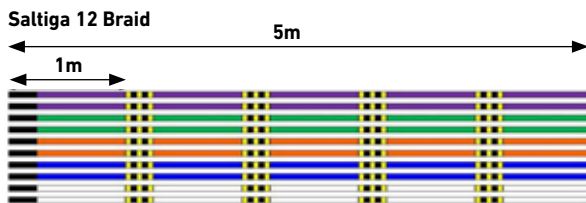

4-Braid

8-Braid

12-Braid

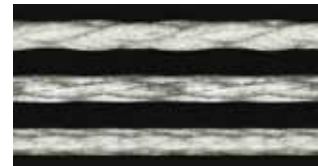

The Saltiga 12 Braid in multi-color is available with 10m marker, allowing you to track your casting distance or fishing depth with ease.

Art.-No.	Color	Capacity m	Ø mm	Strength kg	Strength lb
12696-314	multi-color	300	0.14	12.20	27.0
12696-316	multi-color	300	0.16	14.00	31.0
12696-318	multi-color	300	0.18	16.20	36.0
12696-326	multi-color	300	0.26	24.80	55.0
12696-330	multi-color	300	0.30	30.70	68.0
12696-333	multi-color	300	0.33	39.70	88.0
12696-335	multi-color	300	0.35	45.30	100.0
12696-345	multi-color	300	0.45	53.40	118.0

Art.-No.	Color	Capacity m	Ø mm	Strength kg	Strength lb
12696-614	multi-color	600	0.14	12.20	27.0
12696-616	multi-color	600	0.16	14.00	31.0
12696-618	multi-color	600	0.18	16.20	36.0
12696-626	multi-color	600	0.26	24.80	55.0
12696-630	multi-color	600	0.30	30.70	68.0
12696-633	multi-color	600	0.33	39.70	88.0
12696-635	multi-color	600	0.35	45.30	100.0
12696-645	multi-color	600	0.45	53.40	118.0



- 12-Braid, round-braided
- Silicone surface coating
- Color change every 10m with meter marking
- Extremely high linear strength
- Extremely high wet knot strength
- Extremely high abrasion resistance
- Extremely low frictional resistance
- Made in Japan





TOURNAMENT X8 BRAID EVO+

TOURNAMENT EVO+



The well-known Tournament 8 Braid has been further optimized for the Evo+ version.

Especially the surface coating has been improved by a greater amount of silicone – thus the line produces even less friction during the cast and thereby optimizes casting distances. Additionally, noise generation within the guides is reduced further.

Like this the Tournament 8 Braid Evo+ is technically one of the world's best braided lines at the market. The surface of the Evo+ doesn't split up even at frequent use and maintains its round diameter.

For the new packaging, we additionally reduced the usage of plastic material over 50%.

- 8-Braid, absolutely round-braided
- Silicone surface coating
- High linear strength
- High wet knot strength
- No stretch
- Made in Japan



TOURNAMENT X8 BRAID EVO+

Available colors: dark green, chartreuse, multi-color and white

BRAIDED LINE | MULTI-COLOR

TOURNAMENT X8 BRAID EVO+

BRAIDED LINE | WHITE



A white line is ideally suited for spin fishing during the night and at difficult light conditions, thus we newly included a proper model in the Tournament X8 Braid Evo+ range – the white line doesn't contrast with the sky and thus is nearly invisible for the targeted fish. For the angler, the white color is easy to recognize.

Art.-No.	Color	Capacity m	Ø mm	Strength kg	Strength lb
12763-010	white	135	0.10	6.70	14.7
12763-012	white	135	0.12	8.60	18.8
12763-014	white	135	0.14	10.20	22.4
12763-016	white	135	0.16	12.20	26.8

Art.-No.	Color	Capacity m	Ø mm	Strength kg	Strength lb
12763-310	white	2700	0.10	6.70	14.7
12763-312	white	2700	0.12	8.60	18.8
12763-314	white	2700	0.14	10.20	22.4
12763-316	white	2700	0.16	12.20	26.8

Art.-No.	Color	Capacity m	Ø mm	Strength kg	Strength lb
12762-112	multi-color	300	0.12	8.60	18.8
12762-116	multi-color	300	0.16	12.20	26.8
12762-120	multi-color	300	0.20	18.00	39.7
12762-126	multi-color	300	0.26	19.80	43.7
12762-130	multi-color	300	0.30	23.40	51.6
12762-135	multi-color	300	0.35	35.10	77.4

Art.-No.	Color	Capacity m	Ø mm	Strength kg	Strength lb
12762-216	multi-color	1000	0.16	12.20	26.8
12762-220	multi-color	1000	0.20	18.00	39.7
12762-226	multi-color	1000	0.26	19.80	43.7

Art.-No.	Color	Capacity m	Ø mm	Strength kg	Strength lb
12762-316	multi-color	3000	0.16	12.20	26.8
12762-320	multi-color	3000	0.20	18.00	39.7
12762-326	multi-color	3000	0.26	19.80	43.7
12762-335	multi-color	3000	0.35	35.10	77.4

TOURNAMENT X8 BRAID EVO+

BRAIDED LINE | DARK GREEN



TOURNAMENT X8 BRAID EVO+

BRAIDED LINE | CHARTREUSE



Art.-No.	Color	Capacity m	Ø mm	Strength kg	Strength lb
12760-008	dark green	135	0.08	4.90	10.7
12760-010	dark green	135	0.10	6.70	14.7
12760-012	dark green	135	0.12	8.60	18.8
12760-014	dark green	135	0.14	10.20	22.4
12760-016	dark green	135	0.16	12.20	26.8
12760-018	dark green	135	0.18	15.80	34.7
12760-020	dark green	135	0.20	18.00	39.7

Art.-No.	Color	Capacity m	Ø mm	Strength kg	Strength lb
12761-008	chartreuse	135	0.08	4.90	10.7
12761-010	chartreuse	135	0.10	6.70	14.7
12761-012	chartreuse	135	0.12	8.60	18.8
12761-014	chartreuse	135	0.14	10.20	22.4
12761-016	chartreuse	135	0.16	12.20	26.8
12761-018	chartreuse	135	0.18	15.80	34.7
12761-020	chartreuse	135	0.20	18.00	39.7

Art.-No.	Color	Capacity m	Ø mm	Strength kg	Strength lb
12760-108	dark green	270	0.08	4.90	10.7
12760-110	dark green	270	0.10	6.70	14.7
12760-112	dark green	270	0.12	8.60	18.8
12760-114	dark green	270	0.14	10.20	22.4
12760-116	dark green	270	0.16	12.20	26.8
12760-118	dark green	270	0.18	15.80	34.7
12760-120	dark green	270	0.20	18.00	39.7

Art.-No.	Color	Capacity m	Ø mm	Strength kg	Strength lb
12761-108	chartreuse	270	0.08	4.90	10.7
12761-110	chartreuse	270	0.10	6.70	14.7
12761-112	chartreuse	270	0.12	8.60	18.8
12761-114	chartreuse	270	0.14	10.20	22.4
12761-116	chartreuse	270	0.16	12.20	26.8
12761-118	chartreuse	270	0.18	15.80	34.7
12761-120	chartreuse	270	0.20	18.00	39.7

Art.-No.	Color	Capacity m	Ø mm	Strength kg	Strength lb
12760-208	dark green	900	0.08	4.90	10.7
12760-210	dark green	900	0.10	6.70	14.7
12760-212	dark green	900	0.12	8.60	18.8
12760-214	dark green	900	0.14	10.20	22.4
12760-216	dark green	900	0.16	12.20	26.8
12760-218	dark green	900	0.18	15.80	34.7
12760-220	dark green	900	0.20	18.00	39.7

Art.-No.	Color	Capacity m	Ø mm	Strength kg	Strength lb
12761-208	chartreuse	900	0.08	4.90	10.7
12761-210	chartreuse	900	0.10	6.70	14.7
12761-212	chartreuse	900	0.12	8.60	18.8
12761-214	chartreuse	900	0.14	10.20	22.4
12761-216	chartreuse	900	0.16	12.20	26.8
12761-218	chartreuse	900	0.18	15.80	34.7
12761-220	chartreuse	900	0.20	18.00	39.7

Art.-No.	Color	Capacity m	Ø mm	Strength kg	Strength lb
12760-308	dark green	2700	0.08	4.90	10.7
12760-310	dark green	2700	0.10	6.70	14.7
12760-312	dark green	2700	0.12	8.60	18.8
12760-314	dark green	2700	0.14	10.20	22.4
12760-316	dark green	2700	0.16	12.20	26.8
12760-318	dark green	2700	0.18	15.80	34.7
12760-320	dark green	2700	0.20	18.00	39.7

Art.-No.	Color	Capacity m	Ø mm	Strength kg	Strength lb
12761-308	chartreuse	2700	0.08	4.90	10.7
12761-310	chartreuse	2700	0.10	6.70	14.7
12761-312	chartreuse	2700	0.12	8.60	18.8
12761-314	chartreuse	2700	0.14	10.20	22.4
12761-316	chartreuse	2700	0.16	12.20	26.8
12761-318	chartreuse	2700	0.18	15.80	34.7
12761-320	chartreuse	2700	0.20	18.00	39.7



J-BRAID EXPEDITION X8

NEW

The new J-Braid Expedition is latest addition in the popular J-Braid family.

Featuring the same IZANAS fibre construction that has made J-Braid so popular, but now featuring DAIWA's Silicon „Coating PE“ technology to create a slicker, smoother braid with hydrophobic properties that increases durability & enhances feel.

J-Braid Expedition's silicon coating means the braid does not absorb any water, importantly this means the braid also does not absorb the silt & sediment present in that water which is the #1 cause of braided line wear over time. By shedding the water thanks to its hydrophobic properties, J-Braid Expedition will last longer than traditional braided lines, providing more value & greater performance.

The benefits don't stop there either, with an incredibly high weave count, J-Braid Expedition is braided tighter than almost any other line on the market, providing an incredibly round profile braid which will not separate and fray when in use. DAIWA's history of producing the finest braids on the market is only strengthened with the introduction of J-Braid Expedition. Made in Japan.

- Silicone surface coating
- High linear strength
- High wet knot strength
- No stretch
- Made in Japan



Available in three colour options a smash orange, dark green and multi-color in 150m, 300m and 3000m bulk spools.

J-BRAID EXPEDITION X8

NEW

BRAIDED LINE | SMASH ORANGE



Art.-No.	Color	Capacity m	Ø mm	Strength kg	Strength lb
12550-006	smash orange	150	0.06	5.20	11.5
12550-010	smash orange	150	0.10	6.90	15.2
12550-013	smash orange	150	0.13	8.40	18.5
12550-016	smash orange	150	0.16	9.80	21.6
12550-018	smash orange	150	0.18	12.30	27.2
12550-020	smash orange	150	0.20	16.00	35.3
12550-022	smash orange	150	0.22	19.50	43.1

Art.-No.	Color	Capacity m	Ø mm	Strength kg	Strength lb
12550-106	smash orange	300	0.06	5.20	11.5
12550-110	smash orange	300	0.10	6.90	15.2
12550-113	smash orange	300	0.13	8.40	18.5
12550-116	smash orange	300	0.16	9.80	21.6
12550-118	smash orange	300	0.18	12.30	27.2
12550-120	smash orange	300	0.20	16.00	35.3
12550-122	smash orange	300	0.22	19.50	43.1
12550-124	smash orange	300	0.24	22.20	49.0
12550-128	smash orange	300	0.28	26.40	58.3
12550-132	smash orange	300	0.32	31.00	68.4
12550-135	smash orange	300	0.35	36.00	79.5

Art.-No.	Color	Capacity m	Ø mm	Strength kg	Strength lb
12550-310	smash orange	3000	0.10	6.90	15.2
12550-313	smash orange	3000	0.13	8.40	18.5
12550-316	smash orange	3000	0.16	9.80	21.6
12550-318	smash orange	3000	0.18	12.30	27.2
12550-320	smash orange	3000	0.20	16.00	35.3
12550-322	smash orange	3000	0.22	19.50	43.1
12550-324	smash orange	3000	0.24	22.20	49.0
12550-328	smash orange	3000	0.28	26.40	58.3
12550-332	smash orange	3000	0.32	31.00	68.4
12550-335	smash orange	3000	0.35	36.00	79.5

J-BRAID EXPEDITION X8

NEW

BRAIDED LINE | DARK GREEN



Art.-No.	Color	Capacity m	Ø mm	Strength kg	Strength lb
12551-006	dark green	150	0.06	5.20	11.5
12551-010	dark green	150	0.10	6.90	15.2
12551-013	dark green	150	0.13	8.40	18.5
12551-016	dark green	150	0.16	9.80	21.6
12551-018	dark green	150	0.18	12.30	27.2
12551-020	dark green	150	0.20	16.00	35.3
12551-022	dark green	150	0.22	19.50	43.1

Art.-No.	Color	Capacity m	Ø mm	Strength kg	Strength lb
12551-106	dark green	300	0.06	5.20	11.5
12551-110	dark green	300	0.10	6.90	15.2
12551-113	dark green	300	0.13	8.40	18.5
12551-116	dark green	300	0.16	9.80	21.6
12551-118	dark green	300	0.18	12.30	27.2
12551-120	dark green	300	0.20	16.00	35.3
12551-122	dark green	300	0.22	19.50	43.1
12551-124	dark green	300	0.24	22.20	49.0
12551-128	dark green	300	0.28	26.40	58.3
12551-132	dark green	300	0.32	31.00	68.4
12551-135	dark green	300	0.35	36.00	79.5

Art.-No.	Color	Capacity m	Ø mm	Strength kg	Strength lb
12551-310	dark green	3000	0.10	6.90	15.2
12551-313	dark green	3000	0.13	8.40	18.5
12551-316	dark green	3000	0.16	9.80	21.6
12551-318	dark green	3000	0.18	12.30	27.2
12551-320	dark green	3000	0.20	16.00	35.3
12551-322	dark green	3000	0.22	19.50	43.1
12551-324	dark green	3000	0.24	22.20	49.0
12551-328	dark green	3000	0.28	26.40	58.3
12551-332	dark green	3000	0.32	31.00	68.4
12551-335	dark green	3000	0.35	36.00	79.5

J-BRAID EXPEDITION X8

NEW

BRAIDED LINE | MULTI-COLOR



Art.-No.	Color	Capacity m	Ø mm	Strength kg	Strength lb
12552-110	multi-color	300	0.10	6.90	15.2
12552-113	multi-color	300	0.13	8.40	18.5
12552-116	multi-color	300	0.16	9.80	21.6
12552-118	multi-color	300	0.19	12.30	27.2
12552-120	multi-color	300	0.20	16.00	35.3
12552-122	multi-color	300	0.22	19.50	43.1
12552-124	multi-color	300	0.24	22.20	49.0
12552-128	multi-color	300	0.28	26.40	58.3
12552-132	multi-color	300	0.32	31.00	68.4

Art.-No.	Color	Capacity m	Ø mm	Strength kg	Strength lb
12552-310	multi-color	3000	0.10	6.90	15.2
12552-313	multi-color	3000	0.13	8.40	18.5
12552-316	multi-color	3000	0.16	9.80	21.6
12552-318	multi-color	3000	0.18	12.30	27.2
12552-320	multi-color	3000	0.20	16.00	35.3
12552-322	multi-color	3000	0.22	19.50	43.1
12552-324	multi-color	3000	0.24	22.20	49.0
12552-328	multi-color	3000	0.28	26.40	58.3
12552-332	multi-color	3000	0.32	31.00	68.4
12552-335	multi-color	3000	0.35	36.00	79.5
12552-342	multi-color	3000	0.42	46.40	102.4





J-BRAID GRAND X8

The J-Braid Grand X8 is the advanced version of the world-famous J-Braid X8. To offer even more safety at fishing and at the fight with the fish, the Grand X8 has been optimized regarding important details. The J-Braid Grand X8 fully convinces both at fishing in fresh water for perch, zander or pike and at sea fishing for cod, halibut & co. Compared to the established J-Braid X8 the Grand X8 features a somewhat tighter braid, which results in higher abrasion resistance as well as improved knot strength. By a special manufacturing process, where the J-Braid Grand X8 is stretched, the abrasion resistance and linear strength are furtherly increased. The J-Braid Grand X8 is very supple and somewhat more silent. Since this line is slightly stiffer than the J-Braid X8, it is especially well applicable at windy and difficult casting conditions.

Available colors: light grey, chartreuse, multi-color and blue

- IZANAS® PE fiber
- 8-Braid, round-braided
- Very high knot strength
- Very high abrasion resistance
- No stretch
- Made in Japan



J-BRAID GRAND X8

BRAIDED LINE | LIGHT GREY



Art.-No.	Color	Capacity m	Ø mm	Strength kg	Strength lb
12793-006	light grey	135	0.06	5.00	11.0
12793-010	light grey	135	0.10	7.00	15.0
12793-013	light grey	135	0.13	8.50	19.0
12793-016	light grey	135	0.16	10.00	22.0
12793-018	light grey	135	0.18	12.50	28.0
12793-020	light grey	135	0.20	16.00	35.0
12793-022	light grey	135	0.22	19.50	43.0
12793-024	light grey	135	0.24	22.00	49.0
12793-028	light grey	135	0.28	26.50	58.0

J-BRAID GRAND X8

BRAIDED LINE | CHARTREUSE



Art.-No.	Color	Capacity m	Ø mm	Strength kg	Strength lb
12797-006	chartreuse	135	0.06	5.00	11.0
12797-010	chartreuse	135	0.10	7.00	15.0
12797-013	chartreuse	135	0.13	8.50	19.0
12797-016	chartreuse	135	0.16	10.00	22.0
12797-018	chartreuse	135	0.18	12.50	28.0
12797-020	chartreuse	135	0.20	16.00	35.0
12797-022	chartreuse	135	0.22	19.50	43.0
12797-024	chartreuse	135	0.24	22.00	49.0
12797-028	chartreuse	135	0.28	26.50	58.0

Art.-No.	Color	Capacity m	Ø mm	Strength kg	Strength lb
12797-106	chartreuse	270	0.06	5.00	11.0
12797-110	chartreuse	270	0.10	7.00	15.0
12797-113	chartreuse	270	0.13	8.50	19.0
12797-116	chartreuse	270	0.16	10.00	22.0
12797-118	chartreuse	270	0.18	12.50	28.0
12797-120	chartreuse	270	0.20	16.00	35.0
12797-122	chartreuse	270	0.22	19.50	43.0
12797-124	chartreuse	270	0.24	22.00	49.0

Art.-No.	Color	Capacity m	Ø mm	Strength kg	Strength lb
12797-306	chartreuse	2700	0.06	5.00	11.0
12797-310	chartreuse	2700	0.10	7.00	15.0
12797-313	chartreuse	2700	0.13	8.50	19.0
12797-316	chartreuse	2700	0.16	10.00	22.0
12797-318	chartreuse	2700	0.18	12.50	28.0
12797-320	chartreuse	2700	0.20	16.00	35.0
12797-322	chartreuse	2700	0.22	19.50	43.0
12797-324	chartreuse	2700	0.24	22.00	49.0
12797-328	chartreuse	2700	0.28	26.50	58.0



J-BRAID GRAND X8

BRAIDED LINE | MULTI-COLOR



Art.-No.	Color	Capacity m	Ø mm	Strength kg	Strength lb
12795-006	multi-color	150	0.06	5.00	11.0
12795-010	multi-color	150	0.10	7.00	15.0
12795-013	multi-color	150	0.13	8.50	19.0
12795-016	multi-color	150	0.16	10.00	22.0
12795-018	multi-color	150	0.18	12.50	28.0
12795-020	multi-color	150	0.20	16.00	35.0
12795-022	multi-color	150	0.22	19.50	43.0

Art.-No.	Color	Capacity m	Ø mm	Strength kg	Strength lb
12795-106	multi-color	300	0.06	5.00	11.0
12795-110	multi-color	300	0.10	7.00	15.0
12795-113	multi-color	300	0.13	8.50	19.0
12795-116	multi-color	300	0.16	10.00	22.0
12795-118	multi-color	300	0.18	12.50	28.0
12795-120	multi-color	300	0.20	16.00	35.0
12795-122	multi-color	300	0.22	19.50	43.0
12795-124	multi-color	300	0.24	22.00	49.0
12795-128	multi-color	300	0.26	26.50	58.0

Art.-No.	Color	Capacity m	Ø mm	Strength kg	Strength lb
12795-210	multi-color	1500	0.10	7.00	15.0
12795-213	multi-color	1500	0.13	8.50	19.0
12795-216	multi-color	1500	0.16	10.00	22.0
12795-218	multi-color	1500	0.18	12.50	28.0
12795-220	multi-color	1500	0.20	16.00	35.0
12795-222	multi-color	1500	0.22	19.50	43.0
12795-224	multi-color	1500	0.24	22.00	49.0
12795-228	multi-color	1500	0.28	26.50	58.0

Art.-No.	Color	Capacity m	Ø mm	Strength kg	Strength lb
12795-313	multi-color	3000	0.13	8.50	19.0
12795-316	multi-color	3000	0.16	10.00	22.0
12795-318	multi-color	3000	0.18	12.50	28.0
12795-320	multi-color	3000	0.20	16.00	35.0
12795-322	multi-color	3000	0.22	19.50	43.0
12795-324	multi-color	3000	0.24	22.00	49.0
12795-328	multi-color	3000	0.28	26.50	58.0
12795-335	multi-color	3000	0.35	36.00	79.0

J-BRAID GRAND X8

BRAIDED LINE | BLUE



Art.-No.	Color	Capacity m	Ø mm	Strength kg	Strength lb
12796-006	blue	135	0.06	5.00	11.0
12796-010	blue	135	0.10	7.00	15.0
12796-013	blue	135	0.13	8.50	19.0
12796-016	blue	135	0.16	10.00	22.0
12796-018	blue	135	0.18	12.50	28.0
12796-020	blue	135	0.20	16.00	35.0
12796-022	blue	135	0.22	19.50	43.0
12796-024	blue	135	0.24	22.00	49.0



J-BRAID X8

The J-Braid X8 from DAIWA is an exceptional fishing line, which is braided of 8 single strands and completely fulfills all requirements expected of a high-quality fishing line. Regardless if you want to fish for saltwater predators like halibut, cod and coalfish or aim to target perch or zander – with the new J-Braid you always ensure the proper contact to the fish.

The J-Braid offers the matching diameter for every fishing technique, regardless if sea, river or lake – uncompromising strong and reliable. The J-Braid glides through the guides smoothly and silently, enabling long distances also with lightweight lures. Perfect for spinning and baitcasting reels! Unbelievable price-performance ratio!

Available colors: dark green, chartreuse and multi-color

- 8-Braid, round-braided
- High linear strength
- High abrasion resistance
- No stretch
- Made in Japan



J-BRAID X8

BRAIDED LINE | DARK GREEN



Art.-No.	Color	Capacity m	Ø mm	Strength kg	Strength lb
12751-006	dark green	150	0.06	4.00	9.0
12751-010	dark green	150	0.10	6.00	13.0
12751-013	dark green	150	0.13	8.00	18.0
12751-016	dark green	150	0.16	9.00	20.0
12751-018	dark green	150	0.18	12.00	26.5
12751-020	dark green	150	0.20	13.00	29.0
12751-022	dark green	150	0.22	17.00	37.5
12751-024	dark green	150	0.24	18.00	40.0

Art.-No.	Color	Capacity m	Ø mm	Strength kg	Strength lb
12751-106	dark green	300	0.06	4.00	9.0
12751-110	dark green	300	0.10	6.00	13.0
12751-113	dark green	300	0.13	8.00	18.0
12751-116	dark green	300	0.16	9.00	20.0
12751-118	dark green	300	0.18	12.00	26.5
12751-120	dark green	300	0.20	13.00	29.0
12751-122	dark green	300	0.22	17.00	37.5
12751-124	dark green	300	0.24	18.00	40.0
12751-128	dark green	300	0.28	26.50	58.0
12751-135	dark green	300	0.35	36.00	79.0
12751-142	dark green	300	0.42	46.50	103.0

Art.-No.	Color	Capacity m	Ø mm	Strength kg	Strength lb
12751-206	dark green	1500	0.06	4.00	9.0
12751-210	dark green	1500	0.10	6.00	13.0
12751-213	dark green	1500	0.13	8.00	18.0
12751-216	dark green	1500	0.16	9.00	20.0
12751-218	dark green	1500	0.18	12.00	26.5
12751-220	dark green	1500	0.20	13.00	29.0
12751-222	dark green	1500	0.22	17.00	37.5
12751-224	dark green	1500	0.24	18.00	40.0
12751-228	dark green	1500	0.28	26.50	58.0
12751-235	dark green	1500	0.35	36.00	79.0
12751-242	dark green	1500	0.42	46.50	103.0

Art.-No.	Color	Capacity m	Ø mm	Strength kg	Strength lb
12751-306	dark green	3000	0.06	4.00	9.0
12751-310	dark green	3000	0.10	6.00	13.0
12751-313	dark green	3000	0.13	8.00	18.0
12751-316	dark green	3000	0.16	9.00	20.0
12751-318	dark green	3000	0.18	12.00	26.5
12751-320	dark green	3000	0.20	13.00	29.0
12751-322	dark green	3000	0.22	17.00	37.5
12751-324	dark green	3000	0.24	18.00	40.0
12751-328	dark green	3000	0.28	26.50	58.0
12751-335	dark green	3000	0.35	36.00	79.0
12751-342	dark green	3000	0.42	46.50	103.0
12751-351	dark green	3000	0.51	56.00	123.0
12751-356	dark green	3000	0.56	65.00	143.0



J-BRAID X8

BRAIDED LINE | MULTI-COLOR

Art.-No.	Color	Capacity m	Ø mm	Strength kg	Strength lb
12755-006	multi-color	150	0.06	4.00	9.0
12755-010	multi-color	150	0.10	6.00	13.0
12755-013	multi-color	150	0.13	8.00	18.0
12755-016	multi-color	150	0.16	9.00	20.0
12755-018	multi-color	150	0.18	12.00	26.5
12755-020	multi-color	150	0.20	13.00	29.0
12755-022	multi-color	150	0.22	17.00	37.5

Art.-No.	Color	Capacity m	Ø mm	Strength kg	Strength lb
12755-110	multi-color	300	0.10	6.00	13.0
12755-113	multi-color	300	0.13	8.00	18.0
12755-116	multi-color	300	0.16	9.00	20.0
12755-118	multi-color	300	0.18	12.00	26.5
12755-120	multi-color	300	0.20	13.00	29.0
12755-122	multi-color	300	0.22	17.00	37.5
12755-124	multi-color	300	0.24	18.00	40.0
12755-128	multi-color	300	0.28	26.50	58.0
12755-135	multi-color	300	0.35	36.00	79.0
12755-142	multi-color	300	0.42	46.50	103.0
12755-151	multi-color	300	0.51	56.00	123.0

Art.-No.	Color	Capacity m	Ø mm	Strength kg	Strength lb
12755-213	multi-color	1500	0.13	8.00	18.0
12755-216	multi-color	1500	0.16	9.00	20.0
12755-218	multi-color	1500	0.18	12.00	26.5
12755-220	multi-color	1500	0.20	13.00	29.0
12755-222	multi-color	1500	0.22	17.00	37.5
12755-224	multi-color	1500	0.24	18.00	40.0
12755-228	multi-color	1500	0.28	26.50	58.0
12755-235	multi-color	1500	0.35	36.00	79.0
12755-242	multi-color	1500	0.42	46.50	103.0





J-BRAID X8

BRAIDED LINE | CHARTREUSE



Art.-No.	Color	Capacity m	Ø mm	Strength kg	Strength lb
12750-006	chartreuse	150	0.06	4.00	9.0
12750-010	chartreuse	150	0.10	6.00	13.0
12750-013	chartreuse	150	0.13	8.00	18.0
12750-016	chartreuse	150	0.16	9.00	20.0
12750-018	chartreuse	150	0.18	12.00	26.5
12750-020	chartreuse	150	0.20	13.00	29.0
12750-022	chartreuse	150	0.22	17.00	37.5
12750-024	chartreuse	150	0.24	18.00	40.0
12750-028	chartreuse	150	0.28	26.50	58.0

Art.-No.	Color	Capacity m	Ø mm	Strength kg	Strength lb
12750-106	chartreuse	300	0.06	4.00	9.0
12750-110	chartreuse	300	0.10	6.00	13.0
12750-113	chartreuse	300	0.13	8.00	18.0
12750-116	chartreuse	300	0.16	9.00	20.0
12750-118	chartreuse	300	0.18	12.00	26.5
12750-120	chartreuse	300	0.20	13.00	29.0
12750-122	chartreuse	300	0.22	17.00	37.5
12750-124	chartreuse	300	0.24	18.00	40.0
12750-128	chartreuse	300	0.28	26.50	58.0
12750-135	chartreuse	300	0.35	36.00	79.0
12750-142	chartreuse	300	0.42	46.50	103.0

Art.-No.	Color	Capacity m	Ø mm	Strength kg	Strength lb
12750-206	chartreuse	1500	0.06	4.00	9.0
12750-210	chartreuse	1500	0.10	6.00	13.0
12750-213	chartreuse	1500	0.13	8.00	18.0
12750-216	chartreuse	1500	0.16	9.00	20.0
12750-218	chartreuse	1500	0.18	12.00	26.5
12750-220	chartreuse	1500	0.20	13.00	29.0
12750-222	chartreuse	1500	0.22	17.00	37.5
12750-224	chartreuse	1500	0.24	18.00	40.0
12750-228	chartreuse	1500	0.28	26.50	58.0
12750-235	chartreuse	1500	0.35	36.00	79.0

Art.-No.	Color	Capacity m	Ø mm	Strength kg	Strength lb
12750-306	chartreuse	3000	0.06	4.00	9.0
12750-310	chartreuse	3000	0.10	6.00	13.0
12750-313	chartreuse	3000	0.13	8.00	18.0
12750-316	chartreuse	3000	0.16	9.00	20.0
12750-318	chartreuse	3000	0.18	12.00	26.5
12750-320	chartreuse	3000	0.20	13.00	29.0
12750-322	chartreuse	3000	0.22	17.00	37.5
12750-324	chartreuse	3000	0.24	18.00	40.0
12750-328	chartreuse	3000	0.28	26.50	58.0
12750-335	chartreuse	3000	0.35	36.00	79.0
12750-342	chartreuse	3000	0.42	46.50	103.0
12750-351	chartreuse	3000	0.51	56.00	123.0
12750-356	chartreuse	3000	0.56	65.00	143.0

TOURNAMENT X8 BRAID EVO+ SUPERSLIM UL

BRAIDED LINE | CHARTREUSE

With this line we can offer you the probably most supreme UL line from Japan.

The special micro fiber is woven extremely tight and even thanks to a comprehensive roving procedure and offers a very smooth and round surface, that crosses the rod guides almost completely silent. By the complex roving procedure in combination with the premium raw fiber an extremely high linear strength and abrasion resistance has become possible. With this line you can optimally present even tiniest lures and have enough power reserves also for large specimen.

- 8-Braid, round-braided
- Extremely high linear strength
- Silky smooth suppleness
- Made in Japan



Art.-No.	Color	Capacity m	PE PE No.	Strength kg	Strength lb
12125-003	chartreuse	135	0.3	4.10	9.0
12125-004	chartreuse	135	0.4	5.40	12.0
12125-005	chartreuse	135	0.5	6.40	14.0



SUPERSPOD BRAID

BRAIDED LINE | HI-VIS YELLOW

Premium 4-strand braided line with high abrasion resistance. The Hi-Vis Yellow color allows easy detection at night and over long distances and deters water birds. Made in Japan.

- 4-Braid
- High abrasion resistance
- Made in Japan



Art.-No.	Color	Capacity m	Ø mm	Strength kg	Strength lb
12742-325	hi-vis yellow	300	0.25	14.40	30.0





J-BRAID X4

With the 4-braid line J-Braid, DAIWA offers a real high-performance braided line at an outstanding price-performance ratio. The braiding of the line fulfills highest Japanese quality standards and convinces at all points. The available diameters cover nearly all kinds of fishing techniques from ultra-light fishing for perch to heavy sea fishing for halibut, cod and Co.

Available colors: dark green and yellow

- 4-Braid
- High linear strength
- High knot strength
- High abrasion resistance
- No stretch
- Made in Japan



J-BRAID X4

BRAIDED LINE | DARK GREEN



Art.-No.	Color	Capacity m	Ø mm	Strength kg	Strength lb
12741-007	dark green	135	0.07	2.60	5.5
12741-010	dark green	135	0.10	3.80	9.0
12741-013	dark green	135	0.13	5.90	13.0
12741-015	dark green	135	0.15	6.90	15.0
12741-017	dark green	135	0.17	8.40	19.0
12741-019	dark green	135	0.19	10.20	23.0
12741-021	dark green	135	0.21	12.40	27.0
12741-025	dark green	135	0.25	14.40	32.0

J-BRAID X4

BRAIDED LINE | YELLOW



Art.-No.	Color	Capacity m	Ø mm	Strength kg	Strength lb
12740-007	yellow	135	0.07	2.60	5.5
12740-010	yellow	135	0.10	3.80	9.0
12740-013	yellow	135	0.13	5.90	13.0
12740-015	yellow	135	0.15	6.90	15.0
12740-017	yellow	135	0.17	8.40	19.0
12740-019	yellow	135	0.19	10.20	23.0
12740-021	yellow	135	0.21	12.40	27.0
12740-025	yellow	135	0.25	14.40	32.0

TOURNAMENT SINKING FEEDER BRAID

NEW

BRAIDED LINE | STEEL GREY

- Fast sinking
- High linear strength
- High knot strength
- High abrasion resistance
- No stretch
- Made in Japan

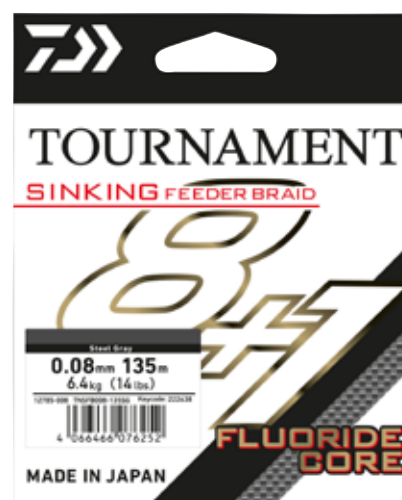

This true sinking feeder braid with special 8+1 construction features a high density Fluoride core to let it sink. The tight woven Japanese material provides a silky surface and smooth release from the spool.

Thanks to the tight 8 braid structure with silicone coating, great reduction of noise throughout the guides is provided during cast. A real outstanding braided line specially designed for feederfishing! Made in Japan.

Art.-No.	Color	Capacity m	Ø mm
12785-008	steel grey	135	0.08
12785-010	steel grey	135	0.10
12785-012	steel grey	135	0.12
12785-014	steel grey	135	0.14



INFINITY® DOUBLE TAPERED MONO

SHOCK LEADER | OLIVE GREEN

The high-quality shock leader from Japan features a double taper and can easily be reversed if required, to regain the full taper. Perfect for mussel banks and rocky ground – the highly abrasion resistant surface offers optimal protection for the line. With 5m in 0.50mm length and 7m tapering down.

- Tapered line construction
- Very high abrasion resistance
- Made in Japan



Art.-No.	Color	Capacity m	Ø mm	Strength lb
12958-014	olive green	320	0.30	14.0
12958-016	olive green	320	0.33	16.0





MONOFIL LINES

TOURNAMENT SF

The Tournament SF combines nearly all preferred technical advantages and benefits in one line. This line has only little stretch – you can thus set the hook instantaneously. The Tournament SF also offers a high wet knot strength and a high abrasion resistance at the same time. The soft and smooth surface glides silently through the guides and optimizes the casting distances.

The Tournament SF thus is one of the world's best lines at the market and one of the most successful mono lines in Japan.

Available colors: grey-clear and green-clear

- High linear strength
- High knot strength
- Excellent wet knot strength
- High abrasion resistance
- Little stretch
- Made in Japan



TOURNAMENT SF

MONOFILAMENT | GREEN TRANSPARENT

Art.-No.	Color	Capacity m	Ø mm	Strength kg	Strength lb
12200-116	green transparent	150	0.16	2.30	5.1
12200-118	green transparent	150	0.18	2.90	6.4
12200-120	green transparent	150	0.20	3.50	7.7
12200-123	green transparent	150	0.23	4.50	9.9
12200-126	green transparent	150	0.26	5.70	12.6
12200-130	green transparent	150	0.30	7.90	17.4

Art.-No.	Color	Capacity m	Ø mm	Strength kg	Strength lb
12200-316	green transparent	300	0.16	2.30	5.1
12200-318	green transparent	300	0.18	2.90	6.4
12200-320	green transparent	300	0.20	3.50	7.7
12200-323	green transparent	300	0.23	4.50	9.9
12200-326	green transparent	300	0.26	5.70	12.6
12200-330	green transparent	300	0.30	7.90	17.4
12200-333	green transparent	300	0.33	9.00	19.8
12200-336	green transparent	300	0.36	11.10	24.5

Art.-No.	Color	Capacity m	Ø mm	Strength kg	Strength lb
12200-616	green transparent	3000	0.16	2.30	5.1
12200-618	green transparent	3000	0.18	2.90	6.4
12200-620	green transparent	3000	0.20	3.50	7.7
12200-623	green transparent	3000	0.23	4.50	9.9
12200-626	green transparent	3000	0.26	5.70	12.6
12200-630	green transparent	3000	0.30	7.90	17.4
12200-633	green transparent	3000	0.33	9.00	19.8
12200-636	green transparent	3000	0.36	11.10	24.5





TOURNAMENT SF

MONOFILAMENT | GREY TRANSPARENT



Art.-No.	Color	Capacity m	Ø mm	Strength kg	Strength lb
12205-116	grey transparent	150	0.16	2.30	5.1
12205-118	grey transparent	150	0.18	2.90	6.4
12205-120	grey transparent	150	0.20	3.50	7.7
12205-123	grey transparent	150	0.23	4.50	9.9
12205-126	grey transparent	150	0.26	5.70	12.6
12205-130	grey transparent	150	0.30	7.90	17.4

Art.-No.	Color	Capacity m	Ø mm	Strength kg	Strength lb
12205-316	grey transparent	300	0.16	2.30	5.1
12205-318	grey transparent	300	0.18	2.90	6.4
12205-320	grey transparent	300	0.20	3.50	7.7
12205-323	grey transparent	300	0.23	4.50	9.9
12205-326	grey transparent	300	0.26	5.70	12.6
12205-330	grey transparent	300	0.30	7.90	17.4
12205-333	grey transparent	300	0.33	9.00	19.8
12205-336	grey transparent	300	0.36	11.10	24.5

Art.-No.	Color	Capacity m	Ø mm	Strength kg	Strength lb
12205-616	grey transparent	3000	0.16	2.30	5.1
12205-618	grey transparent	3000	0.18	2.90	6.4
12205-620	grey transparent	3000	0.20	3.50	7.7
12205-623	grey transparent	3000	0.23	4.50	9.9
12205-626	grey transparent	3000	0.26	5.70	12.6
12205-630	grey transparent	3000	0.30	7.90	17.4
12205-633	grey transparent	3000	0.33	9.00	19.8
12205-636	grey transparent	3000	0.36	11.10	24.5



J-THREADS DPLS NEW

Supple and smooth Japanese quality monofilament with high knot strength featuring the DAIWA Parallel Line-Lay System (DPLS). The parallel line lay keeps the round diameter on the 600m bulk spool during storage period and reduces risk of twist during spooling. Made in Japan.

Available in 3 colors.



- High linear strength
- High knot strength
- High abrasion resistance
- Little stretch
- Made in Japan

J-THREADS DPLS NEW

MONOFILAMENT | KHAKI GOLD

Art.-No.	Color	Capacity m	Ø mm	Strength kg
12225-021	khaki gold	600	0.205	3.10
12225-024	khaki gold	600	0.235	4.10
12225-026	khaki gold	600	0.26	5.10
12225-029	khaki gold	600	0.285	6.10
12225-033	khaki gold	600	0.33	8.10
12225-037	khaki gold	600	0.37	10.10
12225-041	khaki gold	600	0.405	12.50



J-THREADS DPLS NEW

MONOFILAMENT | PINK

Art.-No.	Color	Capacity m	Ø mm	Strength kg
12225-121	pink	600	0.205	3.10
12225-124	pink	600	0.235	4.10
12225-126	pink	600	0.26	5.10
12225-129	pink	600	0.285	6.10
12225-133	pink	600	0.33	8.10
12225-137	pink	600	0.37	10.10
12225-141	pink	600	0.405	12.50



J-THREADS DPLS NEW

MONOFILAMENT | GREY

Art.-No.	Color	Capacity m	Ø mm	Strength kg
12225-221	grey	600	0.205	3.10
12225-224	grey	600	0.235	4.10
12225-226	grey	600	0.26	5.10
12225-229	grey	600	0.285	6.10
12225-233	grey	600	0.33	8.10
12225-237	grey	600	0.37	10.10
12225-241	grey	600	0.405	12.50



MONOFIL LINES

INFINITY® CAMO

With this novel sinking Infinity carp line DAIWA offers a real innovation – thanks to its density of 1.2 this line is considerably heavier than water (approx. 0.99) and thus perfectly drops down right to the bottom. The color unsteadily changes throughout the whole length and inconspicuously adapts to the bottom. The dull surface does not produce any reflections – perfect at heavily frequented waters and cautious fishes.

The new Material has been developed over a long period in our headquarter in Tokyo and is really unique regarding its features. Compared to sinking, stiff fluorocarbon material the new Infinity Sinking is supple and soft and offers a favorable stress-strain-behavior – perfect, to prevent losses during the fight and archive a good knot strength under load.

- Sinking
- High knot strength
- High abrasion resistance
- Made in Japan



green camo



brown camo



MONOFILAMENT | SINKING | 500M | GREEN CAMO

Art.-No.	Color	Capacity m	Ø mm	Strength kg	Strength lb
12767-030	green camo	500	0.30	6.90	16.0
12767-034	green camo	500	0.34	9.20	20.0
12767-037	green camo	500	0.37	10.10	22.0
12767-041	green camo	500	0.41	11.60	24.0

MONOFILAMENT | SINKING | 500M | BROWN CAMO

Art.-No.	Color	Capacity m	Ø mm	Strength kg	Strength lb
12768-030	brown camo	500	0.30	6.90	16.0
12768-034	brown camo	500	0.34	9.20	20.0
12768-037	brown camo	500	0.37	10.10	22.0
12768-041	brown camo	500	0.41	11.60	24.0

MONOFILAMENT | SINKING | MIX | GREEN CAMO

Art.-No.	Color	Capacity m	Ø mm	Strength kg	Strength lb
12767-130	green camo	1210	0.30	6.90	16.0
12767-134	green camo	940	0.34	9.20	20.0
12767-137	green camo	810	0.37	10.10	22.0
12767-141	green camo	710	0.41	11.60	24.0

MONOFILAMENT | SINKING | MIX | BROWN CAMO

Art.-No.	Color	Capacity m	Ø mm	Strength kg	Strength lb
12768-130	brown camo	1210	0.30	6.90	16.0
12768-134	brown camo	940	0.34	9.20	20.0
12768-137	brown camo	810	0.37	10.10	22.0
12768-141	brown camo	710	0.41	11.60	24.0

MONOFILAMENT | SINKING | 3000M | GREEN CAMO

Art.-No.	Color	Capacity m	Ø mm	Strength kg	Strength lb
12767-330	green camo	3000	0.30	6.90	16.0
12767-334	green camo	3000	0.34	9.20	20.0
12767-337	green camo	3000	0.37	10.10	22.0
12767-341	green camo	3000	0.41	11.60	24.0

MONOFILAMENT | SINKING | 3000M | BROWN CAMO

Art.-No.	Color	Capacity m	Ø mm	Strength kg	Strength lb
12768-330	brown camo	3000	0.30	6.90	16.0
12768-334	brown camo	3000	0.34	9.20	20.0
12768-337	brown camo	3000	0.37	10.10	22.0
12768-341	brown camo	3000	0.41	11.60	24.0



MONOFIL LINES

INFINITY® SINKING MONO

With this novel sinking Infinity carp line DAIWA offers a real innovation – thanks to its density of 1.2 this line is considerably heavier than water (approx. 0.99) and thus perfectly drops down right to the bottom.

The new Material has been developed over a long period in our headquarter in Tokyo and is really unique regarding its features. Compared to sinking, stiff fluorocarbon material the new Infinity Sinking is supple and soft and offers a favorable stress-strain-behavior – perfect, to prevent losses during the fight and archive a good knot strength under load.

- Sinking
- High knot strength
- High abrasion resistance
- Made in Japan



MONOFILAMENT | 500M | BROWN

Art.-No.	Color	Capacity m	Ø mm	Strength kg	Strength lb
12765-028	brown	500	0.28	6.30	14.0
12765-030	brown	500	0.30	6.90	16.0
12765-034	brown	500	0.34	9.20	20.0
12765-037	brown	500	0.37	10.10	22.0

MONOFILAMENT | 500M | DARK OLIVE

Art.-No.	Color	Capacity m	Ø mm	Strength kg	Strength lb
12766-028	dark olive	500	0.28	6.30	14.0
12766-030	dark olive	500	0.30	6.90	16.0
12766-034	dark olive	500	0.34	9.20	20.0
12766-037	dark olive	500	0.37	10.10	22.0

MONOFILAMENT | MIX | BROWN

Art.-No.	Color	Capacity m	Ø mm	Strength kg	Strength lb
12765-128	brown	1410	0.28	6.30	14.0
12765-130	brown	1210	0.30	6.90	16.0
12765-134	brown	940	0.34	9.20	20.0
12765-137	brown	810	0.37	10.10	22.0

MONOFILAMENT | MIX | DARK OLIVE

Art.-No.	Color	Capacity m	Ø mm	Strength kg	Strength lb
12766-128	dark olive	1410	0.28	6.30	14.0
12766-130	dark olive	1210	0.30	6.90	16.0
12766-134	dark olive	940	0.34	9.20	20.0
12766-137	dark olive	810	0.37	10.10	22.0

MONOFILAMENT | 3000M | BROWN

Art.-No.	Color	Capacity m	Ø mm	Strength kg	Strength lb
12765-328	brown	3000	0.28	6.30	14.0
12765-330	brown	3000	0.30	6.90	16.0
12765-334	brown	3000	0.34	9.20	20.0
12765-337	brown	3000	0.37	10.10	22.0

MONOFILAMENT | 3000M | DARK OLIVE

Art.-No.	Color	Capacity m	Ø mm	Strength kg	Strength lb
12766-328	dark olive	3000	0.28	6.30	14.0
12766-330	dark olive	3000	0.30	6.90	16.0
12766-334	dark olive	3000	0.34	9.20	20.0
12766-337	dark olive	3000	0.37	10.10	22.0



TOURNAMENT FLUOROCARBON

LEADER LINE | CLEAR

With the Tournament FC leader, which is made of fluorocarbon material to 100%, DAIWA presents one of the most sophisticated Japanese fluorocarbon materials within the Tournament series, which is extremely abrasion resistant and supple. Ideally suited as leader material for fishing in freshwater and at the sea.

By redesigning the packaging, we could reduce the use of plastic material over 50% compared to the previous version.

- Fast sinking
- High linear strength
- Excellent knot strength
- Very high abrasion resistance
- Made in Japan



Art.-No.	Color	Capacity m	Ø mm	Strength kg	Strength lb
12940-014	clear	50	0.14	1.30	3.0
12940-016	clear	50	0.16	1.90	4.0
12940-018	clear	50	0.18	2.30	5.0
12940-020	clear	50	0.20	2.90	6.0
12940-023	clear	50	0.23	4.30	8.0
12940-026	clear	50	0.26	5.20	10.0
12940-030	clear	50	0.30	6.30	12.0
12940-033	clear	50	0.33	7.40	14.0
12940-035	clear	50	0.35	8.10	16.0
12940-040	clear	40	0.40	11.40	20.0
12940-045	clear	28	0.45	12.60	25.0
12940-050	clear	21	0.50	14.40	30.0

J-FLUOROCARBON

LEADER LINE | CLEAR

Thanks to a sophisticated material selection, our Japanese engineers succeeded in developing a very abrasion resistant fluorocarbon leader material with high linear strength, that nevertheless is supple enough to use it also as mainline on your spool. The J-Fluorocarbon offers an outstanding price-performance ratio.

Equipped with spool band.

- Sinking
- High linear strength
- High knot strength
- Very high abrasion resistance
- Made in Japan



Art.-No.	Color	Capacity m	Ø mm	Strength kg	Strength lb
12220-045	clear	50	0.455	11.78	25.0
12220-050	clear	50	0.505	14.47	30.0
12220-065	clear	50	0.645	22.43	40.0
12220-070	clear	50	0.685	24.67	50.0
12220-080	clear	50	0.816	30.56	60.0
12220-090	clear	50	0.887	37.60	80.0

Art.-No.	Color	Capacity m	Ø mm	Strength kg	Strength lb
12220-018	clear	100	0.178	2.31	4.0
12220-020	clear	100	0.20	2.86	5.0
12220-022	clear	100	0.218	3.41	6.0
12220-026	clear	100	0.254	4.48	8.0
12220-028	clear	100	0.278	5.25	10.0
12220-030	clear	100	0.298	5.83	12.0
12220-033	clear	100	0.326	6.84	14.0
12220-035	clear	100	0.352	7.74	16.0
12220-040	clear	100	0.393	9.21	20.0



SALTIGA X'LINK FLUOROCARBON LEADER

LEADER LINE | CLEAR

The utmost premium Saltiga fluorocarbon leader material offers extreme abrasion resistance and highest knot strength. Together with chemical engineers, In cooperation with chemical engineers DAIWA Japan changed the molecular structure of the material, leading to a considerably stronger structure based on nano technology. Thus, the leader not only features a higher knot strength but also the memory effect is considerably reduced – the leader can be smoothed easily. The neoprene spool band can also be used as rod strap. Parallel winding, no memory effect.

- Sinking
- Extremely high knot strength
- Very high abrasion resistance
- Extremely low frictional resistance
- Very high tear strength
- Little stretch
- No memory effect
- Made in Japan



Art.-No.	Color	Capacity m	Ø mm	Strength kg	Strength lb	Content pc.
12956-526	clear	30	0.26	4.50	10.0	1
12956-528	clear	30	0.285	5.40	12.0	1
12956-523	clear	30	0.235	3.60	8.0	1
12956-533	clear	30	0.33	7.30	16.0	1
12956-537	clear	30	0.37	9.10	20.0	1
12956-543	clear	30	0.435	11.30	25.0	1
12956-547	clear	30	0.47	13.60	30.0	1
12956-557	clear	30	0.57	18.10	40.0	1
12956-564	clear	30	0.64	22.70	50.0	1
12956-570	clear	30	0.70	27.20	60.0	1
12956-578	clear	30	0.78	31.80	70.0	1
12956-583	clear	30	0.83	36.30	80.0	1
12956-598	clear	30	0.98	45.40	100.0	1



SALTIGA NYLON LEADER

LEADER LINE | CLEAR

High-class nylon leader material. Very high knot strength but nevertheless supple and easy to apply. By the special material structure, the memory effect is considerably decreased – the leader can be smoothed easily. The neoprene spool band can also be used as rod strap. Parallel winding, no memory effect.

- High linear strength
- Excellent knot strength
- Optimal stretch behaviour
- Very high suppleness
- No memory effect
- Made in Japan



Art.-No.	Color	Capacity m	Ø mm	Strength kg	Strength lb	Content pc.
12957-547	clear	50	0.47	13.60	30.0	1
12957-557	clear	50	0.57	18.10	40.0	1
12957-564	clear	50	0.64	22.70	50.0	1
12957-570	clear	50	0.70	27.20	60.0	1
12957-574	clear	50	0.74	31.80	70.0	1
12957-578	clear	50	0.78	36.30	80.0	1
12957-591	clear	50	0.91	45.40	100.0	1
12957-598	clear	50	0.98	59.00	130.0	1
12957-511	clear	50	1.17	77.10	170.0	1





LURE PROGRAM 2025







PLUGS

The exclusive Japan plugs of our DAIWA Tournament series offer unique masterpieces with highest quality concerning processing and varnish and are made in Japan to 100%. The trend towards premium plugs is going on – which is reasonable because of the significant difference regarding their action – even within the same model series. With the DAIWA Tournament plugs you can rely on optimal action and proven success in many tests and hours of fishing.

The Tournament plugs additionally are designed completely without lead and are equipped with original DAIWA SagSas hooks made in Japan (exception: Model XL Shiner is equipped with Owner hooks).

With the Tournament plugs you can look forward to many successful days of fishing.

TOURNAMENT MEGA SCOUTER | 1064FG

PLUG | FLOATING | DEEP RUNNER

The 68mm Mega Scouter is a very active floating lure with big diving lip, which gains depth very fast, due to its short, bustling movements.

The rattles emit strong vibrations and frequencies you can feel during the retrieve up to the rod during retrieving. Usually the sound even activates lethargic predators and enhances the bite's frequency.

The inside weight system is perfectly balanced to let the main tungsten weight role to the front during a short and strong push of the rod to enable an even steeper diving angle in order to reach depth faster.

- **Category:** plug
- **Lure body:** one-sectioned
- **Type:** with rattles
- **Hooks:** 2 SaqSas treble hooks
- **Type:** floating
- **Diving type:** deep runner
- **Diving depth:** ca. 3.5-5.0m, trolled more than 5.0m
- **Waters:** silent waters
- **Target fishes:** perch, zander, pike
- **Made in Japan**

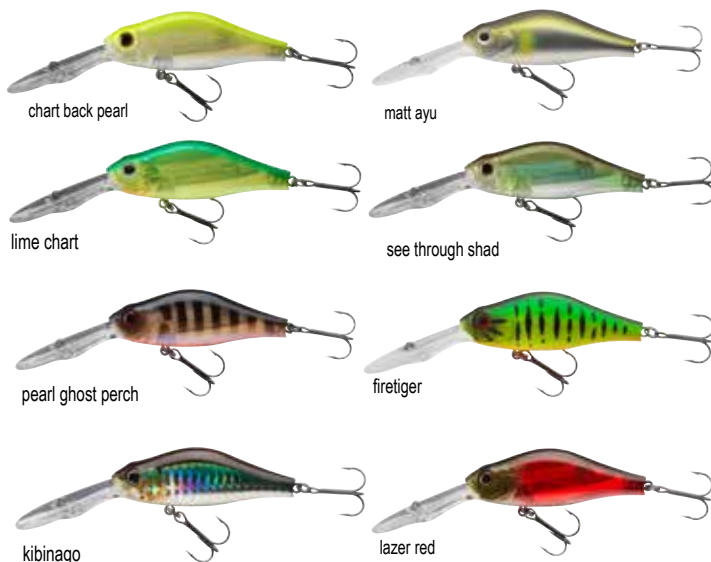

Art.-No.	Color	Length cm	Treble Size	Weight g	Content pc.
16710-001	chart back pearl	6.8	4	14.0	1
16710-002	matt ayu	6.8	4	14.0	1
16710-003	lime chart	6.8	4	14.0	1
16710-004	see through shad	6.8	4	14.0	1
16710-005	pearl ghost perch	6.8	4	14.0	1
16710-006	firetiger	6.8	4	14.0	1
16710-007	kibinago	6.8	4	14.0	1
16710-008	lazer red	6.8	4	14.0	1

TOURNAMENT XL SHINER | 130F-MR

TWITCHBAIT | FLOATING | MEDIUM DEEP RUNNER

The Tournament XL Shiner 130F is an exceptional plug for targeting pike and zander. The 13cm version is ideal to fish mid-water as it dives to about 1.2-2.0m. Simply perfect in the summer when the fish are holding near the surface. Thanks to the patented G.O.S silent weight transfer system, this lure casts like a rocket. Being silent, it is perfect for pressured venues where, more and more, rattles tend to have a counterproductive effect.

Its high buoyancy means that it is perfect to be fished "bottom-bouncing" style, where the lure dives into the bottom and is then left to float back up a bit before diving back down, just deadly. The shape of the XL Shiner's bill takes twitching to another level. Of course, this Tournament plug is 100% made in Japan.

- **Category:** twitchbait
- **Lure body:** one-sectioned
- **Type:** Silent G.O.S. Gravity Oscillation System
- **Hooks:** 2 Owner treble hooks
- **Type:** floating
- **Diving type:** medium deep runner
- **Diving depth:** ca. 1.2-2.0m
- **Waters:** silent & current waters
- **Presentation technique:** twitching
- **Target fishes:** zander, pike
- **Made in Japan**

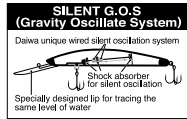

TOURNAMENT BABY MINNOW | 60SP

MINI TWITCHBAIT | SUSPENDING | SHALLOW RUNNER

This classic suspending minnow is perfectly suited for targeting perch, trout and asp. Thanks to the fixed inner weight and the solid center of gravity it is also very well applicable for fishing in currents. Thanks to the missing rattles the proper choice for heavily frequented waters, where usual lures with rattles provoke a rather scaring effect.

A real winner for trouts!

- **Category:** mini twitchbait
- **Lure body:** one-sectioned
- **Type:** silent (without rattles)
- **Hooks:** 2 SaqSas treble hooks
- **Type:** suspending
- **Diving depth:** ca. 0.3-0.8m
- **Waters:** silent & current waters
- **Presentation techniques:** steady retrieve, twitching, stop & go
- **Target fishes:** perch, trout, asp
- **Made in Japan**

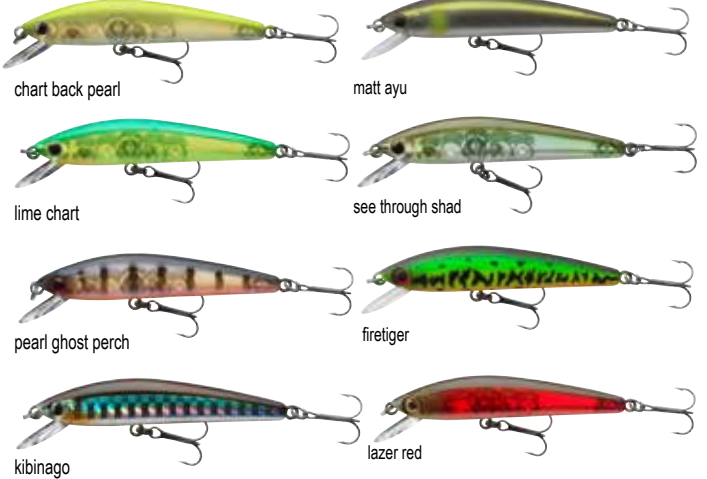
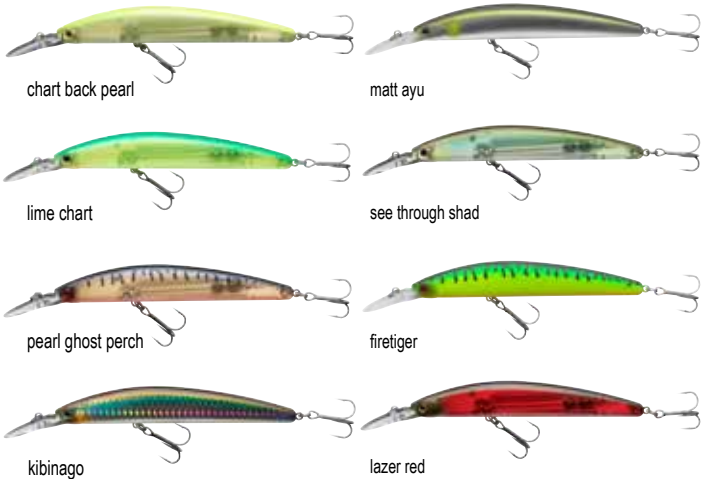

Art.-No.	Color	Length cm	Treble Size	Weight g	Content pc.
16710-101	chart back pearl	13.0	2	22.5	1
16710-102	matt ayu	13.0	2	22.5	1
16710-103	lime chart	13.0	2	22.5	1
16710-104	see through shad	13.0	2	22.5	1
16710-105	pearl ghost perch	13.0	2	22.5	1
16710-106	firetiger	13.0	2	22.5	1
16710-107	kibinago	13.0	2	22.5	1
16710-108	lazer red	13.0	2	22.5	1

Art.-No.	Color	Length cm	Treble Size	Weight g	Content pc.
16710-501	chart back pearl	6.0	10	3.5	1
16710-502	matt ayu	6.0	10	3.5	1
16710-503	lime chart	6.0	10	3.5	1
16710-504	see through shad	6.0	10	3.5	1
16710-505	pearl ghost perch	6.0	10	3.5	1
16710-506	firetiger	6.0	10	3.5	1
16710-507	kibinago	6.0	10	3.5	1
16710-508	lazer red	6.0	10	3.5	1

TOURNAMENT DOUBLE CLUTCH | 60SP-G

MINI TWITCHBAIT | SUSPENDING | SHALLOW RUNNER

With only 60mm, this is the smallest one within the Double Clutch series. The suspending 60SP moves flanking and wobbling, which qualifies this lure for modern presentation techniques like twitching and jerkbaiting as well as for steady retrieving or trolling. Thanks to the patented Silent G.O.S. Balancer System, this lure displays excellent casting characteristics regardless its low own weight. The Double Clutch 60SP is a real insider tip for overfished waters and did fully convince at out tests, where it performed ultimately successful at catching perch and trout.

- **Category:** mini twitchbait
- **Lure body:** one-sectioned
- **Type:** Silent G.O.S. Gravity Oscillation System
- **Hooks:** 2 SaqSas treble hooks
- **Type:** suspending
- **Diving depth:** ca. 0.5-1.3m, trolled up to ca. 1.8m
- **Presentation techniques:** twitching, jerkbaiting, trolling
- **Target fishes:** perch, trout
- **Made in Japan**

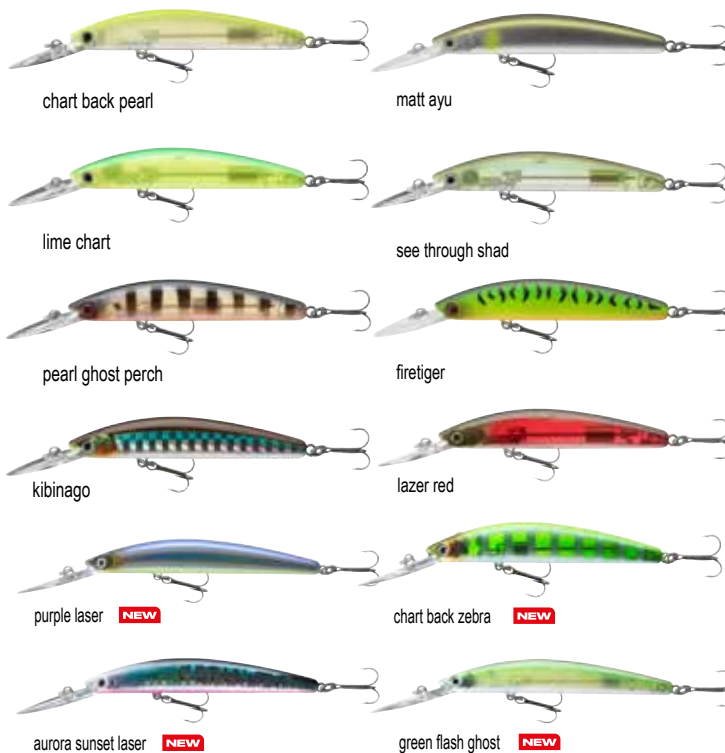
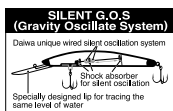

Art.-No.	Color	Length cm	Treble Size	Weight g	Content pc.
16710-201	chart back pearl	6.0	12	3.6	1
16710-202	matt ayu	6.0	12	3.6	1
16710-203	lime chart	6.0	12	3.6	1
16710-204	see through shad	6.0	12	3.6	1
16710-205	pearl ghost perch	6.0	12	3.6	1
16710-206	firetiger	6.0	12	3.6	1
16710-207	kibinago	6.0	12	3.6	1
16710-208	lazer red	6.0	12	3.6	1
NEW 16710-209	purple laser	6.0	12	3.6	1
NEW 16710-210	chart back zebra	6.0	12	3.6	1
NEW 16710-211	aurora sunset laser	6.0	12	3.6	1
NEW 16710-212	green flash ghost	6.0	12	3.6	1

TOURNAMENT DOUBLE CLUTCH | 75SP-G

TWITCHBAIT | SUSPENDING | SHALLOW RUNNER

The Tournament Double Clutch 75 is one of the most successful lures in Japan and already proved many times to achieve exceptional catches. During test fishing in Germany we could entrap pike and perch even with simple retrieving techniques. With it's slim shape of the body it imitates perfectly small prey fish like e.g. a bleak. The Double Clutch is a suspender and can be fished almost on place as soon as it is brought down to depth. The action of the Double Clutch is a mixture between flanking and wobbling movements that are well suited for twitching- and jerking- techniques.

- **Category:** twitchbait
- **Lure body:** one-sectioned
- **Type:** Silent G.O.S. Gravity Oscillation System
- **Hooks:** 2 SaqSas treble hooks
- **Type:** suspending
- **Diving depth:** ca. 0.5-1.5m, trolled up to ca. 2.0m
- **Presentation techniques:** steady retrieve, twitching, stop & go
- **Target fishes:** perch, pike
- **Made in Japan**

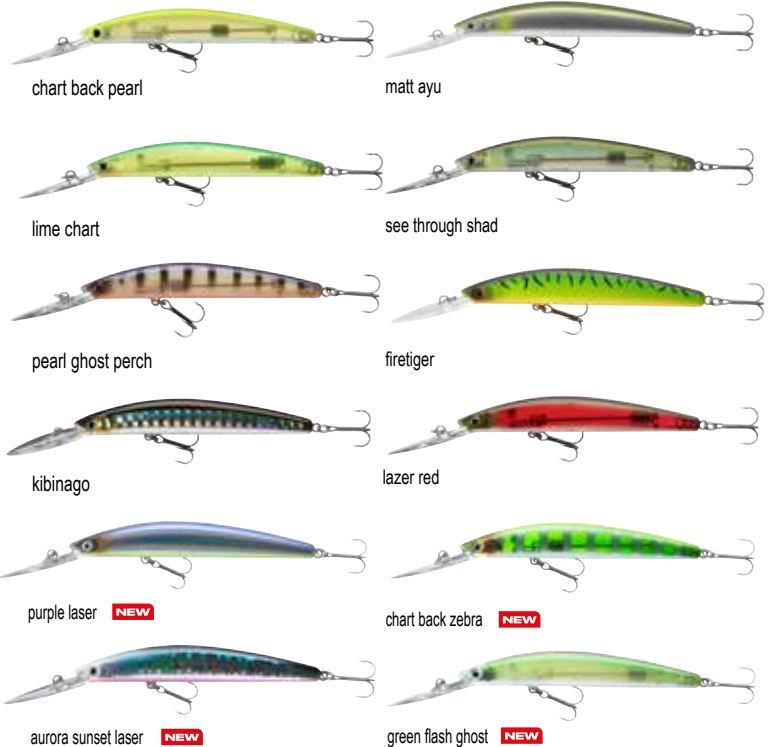
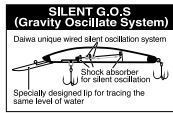

Art.-No.	Color	Length cm	Treble Size	Weight g	Content pc.
16710-301	chart back pearl	7.5	10	5.0	1
16710-302	matt ayu	7.5	10	5.0	1
16710-303	lime chart	7.5	10	5.0	1
16710-304	see through shad	7.5	10	5.0	1
16710-305	pearl ghost perch	7.5	10	5.0	1
16710-306	firetiger	7.5	10	5.0	1
16710-307	kibinago	7.5	10	5.0	1
16710-308	lazer red	7.5	10	5.0	1
NEW 16710-309	purple laser	7.5	10	5.0	1
NEW 16710-310	chart back zebra	7.5	10	5.0	1
NEW 16710-311	aurora sunset laser	7.5	10	5.0	1
NEW 16710-312	green flash ghost	7.5	10	5.0	1

TOURNAMENT DOUBLE CLUTCH | 95SP-G

TWITCHBAIT | SUSPENDING | MEDIUM DEEP RUNNER

The big brother of the 75mm version.

Due to its slim body shape, small prey fish, like bleaks, are perfectly imitated. Thanks to its "suspender"-qualities, this plug can be fished nearly in stagnation.

Short, powerful strokes and speed-ups animate the Double Clutch 95SP to show a very catchy action, which no predator can resist.

Due to the patented „Silent Gravity Oscillating System" one can reach great casting distances – additionally this "silent" plug is perfectly fitting for highly frequented waters, in which plugs with the usual rattles are already well known among the predators.

Also a very successful choice for targeting zanders at nighttime.

- **Category:** twitchbait
- **Lure body:** one-sectioned
- **Type:** Silent G.O.S. Gravity Oscillation System
- **Hooks:** 3 SaqSas treble hooks
- **Type:** suspending
- **Diving depth:** ca. 1.5-2.5m, trolled up to ca. 3.0m
- **Presentation techniques:** steady retrieve, twitching, stop & go
- **Target fishes:** zander, pike
- **Made in Japan**

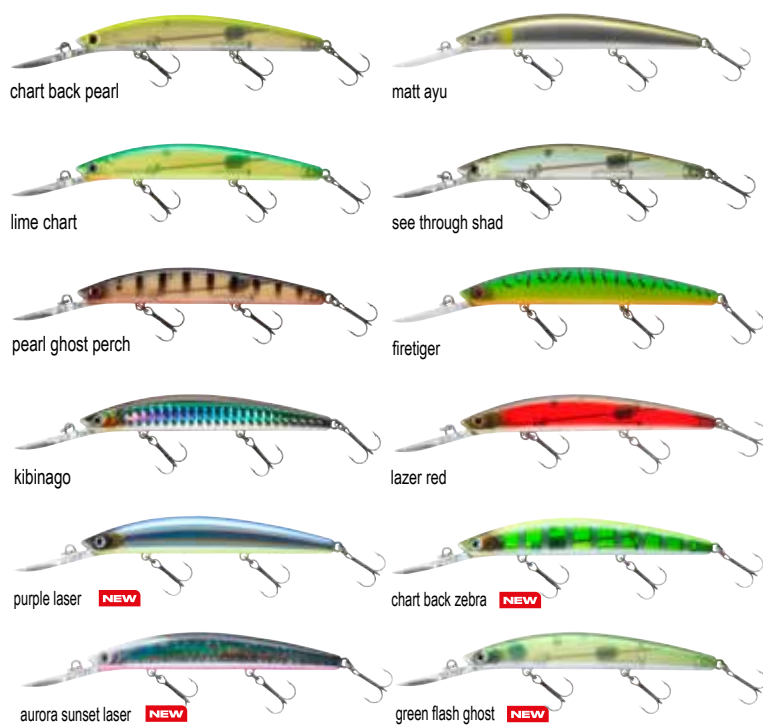

Art.-No.	Color	Length cm	Treble Size	Weight g	Content pc.
16710-401	chart back pearl	9.5	8	8.8	1
16710-402	matt ayu	9.5	8	8.8	1
16710-403	lime chart	9.5	8	8.8	1
16710-404	see through shad	9.5	8	8.8	1
16710-405	pearl ghost perch	9.5	8	8.8	1
16710-406	firetiger	9.5	8	8.8	1
16710-407	kibinago	9.5	8	8.8	1
16710-408	lazer red	9.5	8	8.8	1
NEW 16710-409	purple laser	9.5	8	8.8	1
NEW 16710-410	chart back zebra	9.5	8	8.8	1
NEW 16710-411	aurora sunset laser	9.5	8	8.8	1
NEW 16710-412	green flash ghost	9.5	8	8.8	1

TOURNAMENT SPIKE | 53SP-MR

MINI TWITCHBAIT | SUSPENDING | MEDIUM DEEP RUNNER

The Spike has been developed by one of the most famous bass pros in Japan, Toshi Namiki, in cooperation with DAIWA.

The Spike is a plug for medium diving depths, which is getting down very fast after the cast - consequently the lure is running in the preferred depth for a longer time. It is also perfectly suited for fishing in areas close to the shore. The special design and the compact shape enable great casting distances - ideal for baitcast reels!
The Spike is also perfectly fitting for fishing for perch, asp and zander.

- Lure body: one-sectioned
- Type: Round Weight Ball Oscillation System (with light rattle noises)
- Hooks: 2 SaqSas treble hooks
- Type: suspending
- Diving type: medium deep runner
- Diving depth: ca. 2.0m, trolled up to ca. 2.5m
- Presentation techniques: steady retrieve, twitching, stop & go
- Target fishes: perch, zander, asp
- Made in Japan



TOURNAMENT BABY CRANK | 35F-SR

MINI CRANKBAIT | FLOATING | SHALLOW RUNNER

One of the smallest within the program!

The 35mm Baby Crank emits strong vibrations even at slow retrieving and moves very wobbly through the water. The thin diving lip is made of robust plastic and helps gaining depth quickly.

Especially perch go crazy when this lure is fished variously and provokes intense bites. This floating lure is very well suited to be presented under overhanging bushes in order to catch trouts.

- Category: mini crankbait
- Lure body: one-sectioned
- Type: silent (without rattles)
- Hooks: 2 SaqSas treble hooks
- Type: floating
- Diving type: shallow runner
- Diving depth: ca. 0.3-1.5m
- Presentation techniques: steady retrieve, twitching, stop & go
- Target fishes: perch, trout, chub
- Made in Japan



Art.-No.	Color	Length cm	Treble Size	Weight g	Content pc.
16710-601	chart back pearl	5.3	8	5.0	1
16710-602	matt ayu	5.3	8	5.0	1
16710-603	lime chart	5.3	8	5.0	1
16710-604	see through shad	5.3	8	5.0	1
16710-605	pearl ghost perch	5.3	8	5.0	1
16710-606	firetiger	5.3	8	5.0	1
16710-607	kibinago	5.3	8	5.0	1
16710-608	lazer red	5.3	8	5.0	1

Art.-No.	Color	Length cm	Treble Size	Weight g	Content pc.
16710-701	chart back pearl	3.5	12	3.5	1
16710-702	matt ayu	3.5	12	3.5	1
16710-703	lime chart	3.5	12	3.5	1
16710-704	see through shad	3.5	12	3.5	1
16710-705	pearl ghost perch	3.5	12	3.5	1
16710-706	firetiger	3.5	12	3.5	1
16710-707	kibinago	3.5	12	3.5	1
16710-708	lazer red	3.5	12	3.5	1



TOURNAMENT CURRENT MASTER | 93F-SR

TWITCHBAIT | FLOATING | SHALLOW RUNNER

The Tournament Current Master SR is made for the upper water levels and is ideally suited for asp.

Thanks to the construction of its body and diving lip it can be fished very fast and it will not break out sideways and lose its action— ideal for rivers and streams.

This lure shows its full potential when it is presented variously. With the Current Master you can literally provoke the target fish by letting the lure dance vividly on the spot to seduce also dull predators.

- **Category:** twitchbait
- **Lure body:** one-sectioned
- **Type:** Mag Lock Silent Weight Oscillation System
- **Hooks:** 2 SaqSas treble hooks
- **Type:** floating
- **Diving type:** shallow runner
- **Diving depth:** ca. 0.8-1.5m
- **Waters:** silent & current waters
- **Presentation techniques:** steady retrieve, twitching, stop & go
- **Speed:** fast
- **Target fishes:** perch, trout, asp, zander, pike
- **Made in Japan**

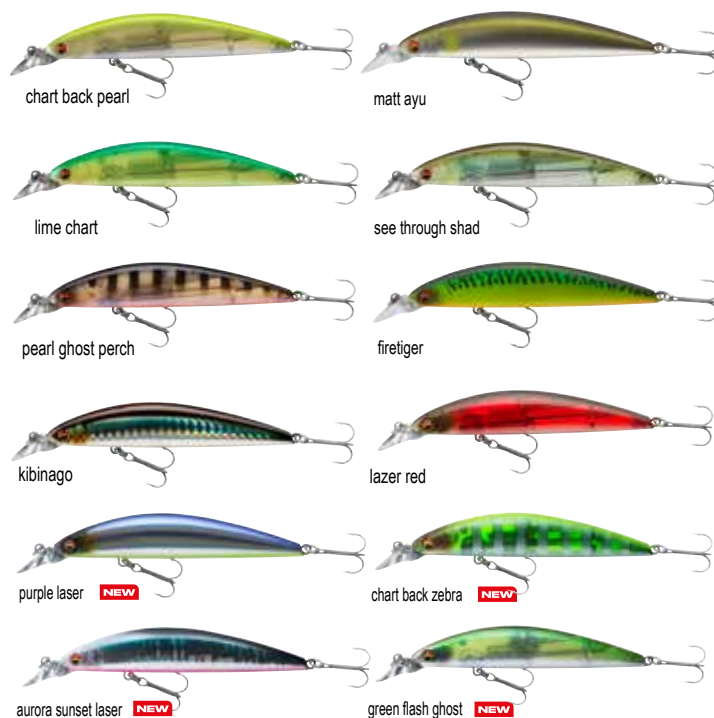

Art.-No.	Color	Length cm	Treble Size	Weight g	Content pc.
16711-001	chart back pearl	9.3	6	12.0	1
16711-002	matt ayu	9.3	6	12.0	1
16711-003	lime chart	9.3	6	12.0	1
16711-004	see through shad	9.3	6	12.0	1
16711-005	pearl ghost perch	9.3	6	12.0	1
16711-006	firetiger	9.3	6	12.0	1
16711-007	kibinago	9.3	6	12.0	1
16711-008	lazer red	9.3	6	12.0	1
NEW 16711-009	purple laser	9.3	6	12.0	1
NEW 16711-010	chart back zebra	9.3	6	12.0	1
NEW 16711-011	aurora sunset laser	9.3	6	12.0	1
NEW 16711-012	green flash ghost	9.3	6	12.0	1

TOURNAMENT CURRENT MASTER | 93F-DR

TWITCHBAIT | FLOATING | DEEP RUNNER

This 93mm floating lure is a real secret weapon for zander, perch and asp. The DR model is made for medium water levels. By the patented „Mag Lock Silent Weight Oscillation System“, exceptional casting distances can be achieved. The special construction of the body and the diving lip makes this lure also suitable for fishing in stronger currents and rivers. Strong flanking and suspending action make this lure the perfect choice for twitching and stop-and-go techniques.



- **Category:** twitchbait
- **Lure body:** one-sectioned
- **Type:** Mag Lock Silent Weight Oscillation System
- **Hooks:** 2 SaqSas treble hooks
- **Type:** floating
- **Diving type:** deep runner
- **Diving depth:** ca. 2.0-3.0m
- **Waters:** silent & current waters
- **Presentation techniques:** steady retrieve, twitching, stop & go
- **Speed:** fast
- **Target fishes:** perch, trout, asp, zander, pike
- **Made in Japan**

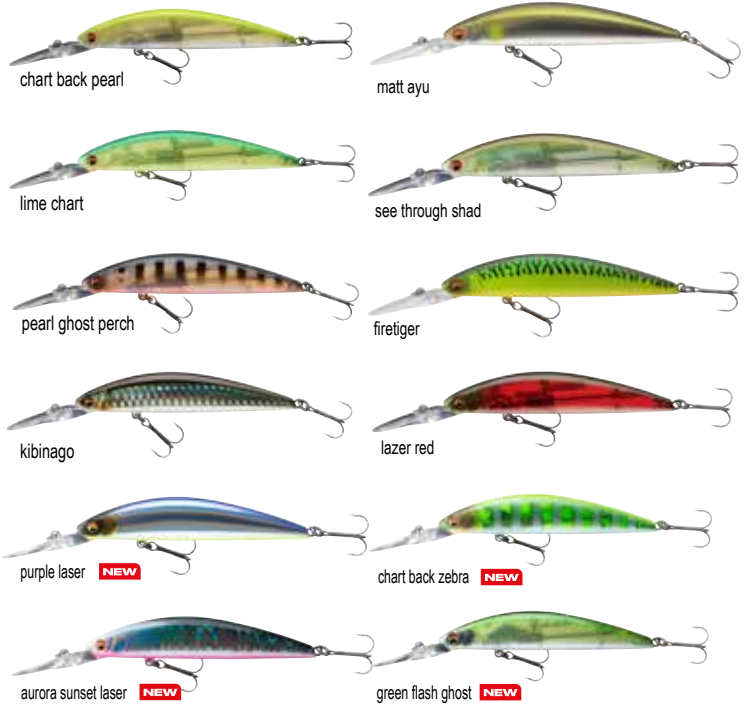
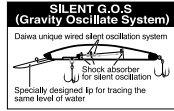

Art.-No.	Color	Length cm	Treble Size	Weight g	Content pc.
16711-101	chart back pearl	9.3	6	12.0	1
16711-102	matt ayu	9.3	6	12.0	1
16711-103	lime chart	9.3	6	12.0	1
16711-104	see through shad	9.3	6	12.0	1
16711-105	pearl ghost perch	9.3	6	12.0	1
16711-106	firetiger	9.3	6	12.0	1
16711-107	kibinago	9.3	6	12.0	1
16711-108	lazer red	9.3	6	12.0	1
NEW 16711-109	purple laser	9.3	6	12.0	1
NEW 16711-110	chart back zebra	9.3	6	12.0	1
NEW 16711-111	aurora sunset laser	9.3	6	12.0	1
NEW 16711-112	green flash ghost	9.3	6	12.0	1



TOURNAMENT WISE MINNOW | 50FS

MINNOWBAIT | FAST SINKING

An exceptional lure for ultra-light fishing.

By the rather fast sinking behavior the Wise Minnow 50FS is ideal to reach depth quickly, which is required when targeting deeper spots in streams and rivers. The tungsten weight is fixed inside the body and provides good stability to the lure even in stronger currents.

The Wise Minnow has flanking movements and is a real magnet for trout and perch.

- **Category:** minnowbait
- **Lure body:** one-sectioned
- **Type:** silent (without rattles)
- **Hooks:** 2 SaqSas treble hooks
- **Type:** fast sinking
- **Waters:** current waters
- **Presentation techniques:** steady retrieve, twitching, stop & go
- **Target fishes:** perch, trout
- **Made in Japan**



chart back pearl



matt ayu



lime chart



see through shad



pearl ghost perch



firetiger



kibinago



lazer red



purple laser

NEW



chart back zebra

NEW



aurora sunset laser

NEW



green flash ghost

NEW

Art.-No.	Color	Length cm	Treble Size	Weight g	Content pc.
16711-201	chart back pearl	5.0	12	5.2	1
16711-202	matt ayu	5.0	12	5.2	1
16711-203	lime chart	5.0	12	5.2	1
16711-204	see through shad	5.0	12	5.2	1
16711-205	pearl ghost perch	5.0	12	5.2	1
16711-206	firetiger	5.0	12	5.2	1
16711-207	kibinago	5.0	12	5.2	1
16711-208	lazer red	5.0	12	5.2	1
NEW 16711-220	purple laser	5.0	12	5.2	1
NEW 16711-221	chart back zebra	5.0	12	5.2	1
NEW 16711-222	aurora sunset laser	5.0	12	5.2	1
NEW 16711-223	green flash ghost	5.0	12	5.2	1

TOURNAMENT WISE MINNOW | 70FS

MINNOWBAIT | FAST SINKING

This sinking model can be cast conveniently and is perfectly suitable for scanning particular water layers – especially in autumn and winter, when conventional swimming minnows only lead to little success. With this sinking model you can scan water areas also close to the bottom, which is especially successful at cold weather. The tungsten weight is fixed within the body of the Wise Minnow 70FS and equips this lure with a stable action even in rough currents.

- **Category:** minnowbait
- **Lure body:** one-sectioned
- **Type:** silent (without rattles)
- **Hooks:** 2 SaqSas treble hooks
- **Type:** fast sinking
- **Waters:** current waters
- **Presentation techniques:** steady retrieve, twitching, stop & go
- **Target fishes:** perch, trout
- **Made in Japan**

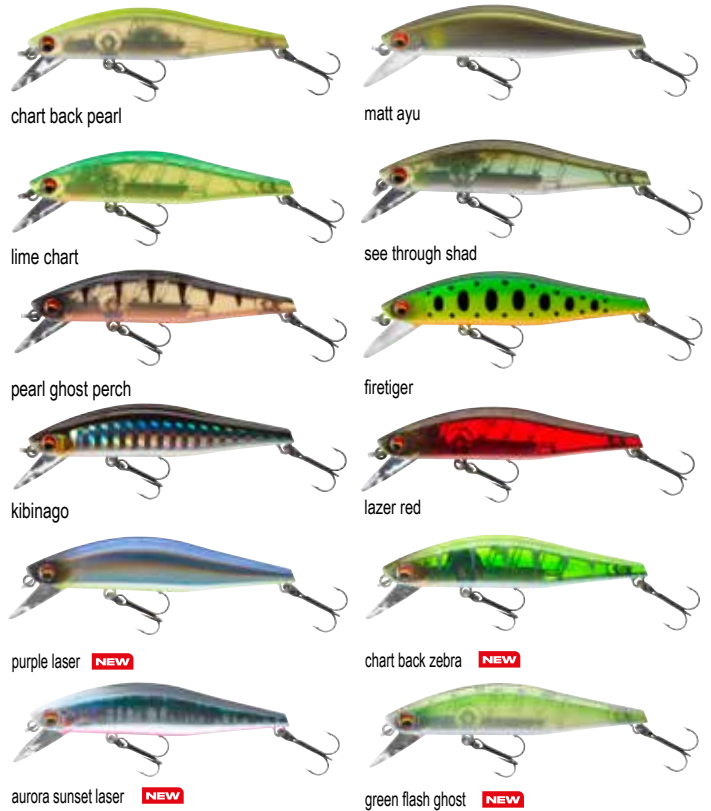

Art.-No.	Color	Length cm	Treble Size	Weight g	Content pc.
16711-301	chart back pearl	7.0	10	7.5	1
16711-302	matt ayu	7.0	10	7.5	1
16711-303	lime chart	7.0	10	7.5	1
16711-304	see through shad	7.0	10	7.5	1
16711-305	pearl ghost perch	7.0	10	7.5	1
16711-306	firetiger	7.0	10	7.5	1
16711-307	kibinago	7.0	10	7.5	1
16711-308	lazer red	7.0	10	7.5	1
NEW 16711-320	purple laser	7.0	10	7.5	1
NEW 16711-321	chart back zebra	7.0	10	7.5	1
NEW 16711-322	aurora sunset laser	7.0	10	7.5	1
NEW 16711-323	green flash ghost	7.0	10	7.5	1



TOURNAMENT TIGHTWAVE SHAD

NEW

MINNOWBAIT | FLOATING | SHALLOW RUNNER

The Tight Wave Shad is a classic twitchbait that creates strong flanking action and turbulences under water. A perfect lure for night fishing in shallow areas for zander! Thanks to the transparent surface and inner holographic foil, this lure will generate short flashes on every tiny twitch and attract attention.

Made in Japan.

- **Category:** minnowbait
- **Lure body:** one-sectioned
- **Hooks:** 2 SaqSas treble hooks
- **Type:** floating
- **Diving depth:** ca. 0.8-1.5m
- **Presentation techniques:** steady retrieve, twitching, stop & go
- **Speed:** slow and fast
- **Target fishes:** perch, trout, chub, zander, pike
- **Made in Japan**



pearl ghost perch



see through shad



see through ayu



wakasagi



green ghost



Art.-No.	Color	Length mm	Treble Size	Weight g	Content pc.
16712-001	pearl ghost perch	75	8	9.0	1
16712-002	see through shad	75	8	9.0	1
16712-003	see through ayu	75	8	9.0	1
16712-004	wakasagi	75	8	9.0	1
16712-005	green ghost	75	8	9.0	1

TOURNAMENT



TOURNAMENT MINNOW

The two Minnows from the Tournament range are designed for targeting the upper water layers and are ideally suited for zander fishing at nighttime or when predators hunt close to the surface in early summer. Thanks to the lead-free Silent G.O.S. Oscillate System the Tournament Minnow can be cast precisely. Perfect for twitching and jerkbaiting.

The 120mm model features extra-strong treble hooks.



- **Category:** twitchbait
- **Lure body:** one-sectioned
- **Type:** Silent Wired Oscillation System (brass)
- **Hooks:** 2 SaqSas treble hooks
- **Type:** floating, suspending, sinking
- **Presentation techniques:** twitching, jerkbaiting
- **Made in Japan**

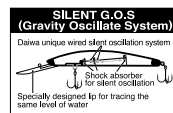

pearl ghost perch



kibunago



aurora zebra



ayu



gold lense



golden shiner

TOURNAMENT MINNOW | 95SP

TWITCHBAIT | SUSPENDING | SHALLOW RUNNER

Art.-No.	Color	Length cm	Weight g	Content pc.
16711-601	pearl ghost perch	9.5	9.5	1
16711-602	kibunago	9.5	9.5	1
16711-603	aurora zebra	9.5	9.5	1
16711-604	ayu	9.5	9.5	1
16711-605	gold lense	9.5	9.5	1
16711-606	golden shiner	9.5	9.5	1

TOURNAMENT MINNOW | 120SP

TWITCHBAIT | SUSPENDING | SHALLOW RUNNER

Art.-No.	Color	Length cm	Weight g	Content pc.
16711-701	pearl ghost perch	12.0	14.5	1
16711-702	kibunago	12.0	14.5	1
16711-703	aurora zebra	12.0	14.5	1
16711-704	ayu	12.0	14.5	1
16711-705	gold lense	12.0	14.5	1
16711-706	golden shiner	12.0	14.5	1



SOFT PLASTIC LURES

TOURNAMENT D'FIN

Shad with classic paddle tail. The D'Fin generates strong flanking moves even without jighead. A real nightmare for zander and perch.

Due to the special rubber formulation and the addition of salt, this shad can even be fished without jighead and is ideally suited for the use of off-set hooks – perfect for weedy areas.

The rubber contains squid flavor, which receives most bites also when fishing in fresh water. The rubber formulation is color neutral – different colors can be stored together without blending into each other. Made in Japan.



TOURNAMENT



goby



pepper ghost



smoke shad



motor oil ayu



chartreuse ayu



chartreuse



pearl



green/pearl



orange shiner



lime



rainbow shad



ayu



orange sunrise



UV crush candy



UV lime pearl



UV violet



UV perch



UV chartreuse tiger



UV hot tomato



UV real motor oil



UV flake pearl



UV chartreuse tiger



UV crush candy



UV violet



UV perch



UV hot tomato

TOURNAMENT D'FIN | 75MM

SHAD

Art.-No.	Color	Length cm	Content pc.
16500-008	motor oil ayu	7.5	10
16500-108	green/pearl	7.5	10
16500-208	chartreuse ayu	7.5	10
16500-308	chartreuse	7.5	10
16500-408	pearl	7.5	10
16500-508	ayu	7.5	10
16500-608	orange shiner	7.5	10
16501-208	lime	7.5	10
16501-408	rainbow shad	7.5	10
16502-108	UV crush candy	7.5	10
16502-208	UV lime pearl	7.5	10
16502-308	UV violet	7.5	10
16502-408	UV perch	7.5	10
16502-508	UV chartreuse tiger	7.5	10
16502-608	UV hot tomato	7.5	10
16502-708	UV real motor oil	7.5	10
16502-808	UV flake pearl	7.5	10
16502-908	orange sunrise	7.5	10
16504-308	goby	7.5	10
16504-508	pepper ghost	7.5	10
16504-608	smoke shad	7.5	10

TOURNAMENT D'FIN | 100MM

SHAD

Art.-No.	Color	Length cm	Content pc.
16500-010	motor oil ayu	10.0	7
16500-110	green/pearl	10.0	7
16500-210	chartreuse ayu	10.0	7
16500-310	chartreuse	10.0	7
16500-410	pearl	10.0	7
16500-510	ayu	10.0	7
16500-610	orange shiner	10.0	7
16501-210	lime	10.0	7
16501-410	rainbow shad	10.0	7
16502-110	UV crush candy	10.0	7
16502-210	UV lime pearl	10.0	7
16502-310	UV violet	10.0	7
16502-410	UV perch	10.0	7
16502-510	UV chartreuse tiger	10.0	7
16502-610	UV hot tomato	10.0	7
16502-710	UV real motor oil	10.0	7
16502-810	UV flake pearl	10.0	7
16502-910	orange sunrise	10.0	7
16504-310	goby	10.0	7
16504-510	pepper ghost	10.0	7
16504-610	smoke shad	10.0	7

TOURNAMENT D'FIN | 125MM

SHAD

Art.-No.	Color	Length cm	Content pc.
16500-012	motor oil ayu	12.5	5
16500-112	green/pearl	12.5	5
16500-212	chartreuse ayu	12.5	5
16500-312	chartreuse	12.5	5
16500-412	pearl	12.5	5
16500-512	ayu	12.5	5
16500-612	orange shiner	12.5	5
16501-212	lime	12.5	5
16501-412	rainbow shad	12.5	5
16502-112	UV crush candy	12.5	5
16502-212	UV lime pearl	12.5	5
16502-312	UV violet	12.5	5
16502-412	UV perch	12.5	5
16502-512	UV chartreuse tiger	12.5	5
16502-612	UV hot tomato	12.5	5
16502-712	UV real motor oil	12.5	5
16502-812	UV flake pearl	12.5	5
16502-912	orange sunrise	12.5	5
16504-312	goby	12.5	5
16504-512	pepper ghost	12.5	5
16504-612	smoke shad	12.5	5

TOURNAMENT D'FIN | 150MM

SHAD

The Catch-Giant from Japan – thanks to the great demand, now also available in a 15cm version for zander and pike. The rubber has been chosen somewhat harder compared to the smaller models to resist longer against powerful pikes. With 15cm, the big D'Fin is also ideally made for big zander – the special squid flavor enhances the bite frequency. Made in Japan.

Art.-No.	Color	Length cm	Content pc.
16505-015	motor oil ayu	15.0	3
16505-115	chartreuse ayu	15.0	3
16505-215	pearl	15.0	3
16505-315	ayu	15.0	3
16505-415	lime	15.0	3
16505-515	UV lime pearl	15.0	3
16505-615	UV chartreuse tiger	15.0	3
16505-715	UV hot tomato	15.0	3
16505-815	UV real motor oil	15.0	3
16505-915	UV flake pearl	15.0	3



GRANDWAVE SEA PROGRAM

With the GrandWave sea program DAIWA presents a small but excellent range of approved sea rigs for Norway as well as the North and the Baltic Sea. All components and rigs are produced to fulfill highest quality demands concerning materials and processing. At this program not price but high quality and user comfort are focused!

GRANDWAVE MACKEREL RIG 360°

Classical mackerel rig with feathers. The rotating bead prevents tangling even with full-houses and thus can be reused many times.

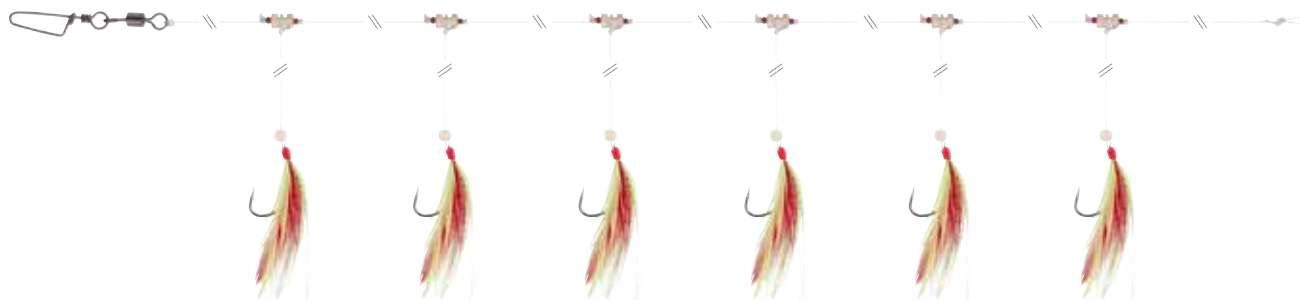

GRANDWAVE MACKEREL RIG 360°

WITH FEATHERS | RED / YELLOW

Art.-No.	Color	Rig Length cm	Hook Size	Ø Line mm	Ø Side-Arm mm	Content pc.
16517-210	red/yellow	135.0	2/0	0.60	0.40	1



GRANDWAVE MACKEREL RIG 360°

WITH FEATHERS | WHITE / RED

Art.-No.	Color	Rig Length cm	Hook Size	Ø Line mm	Ø Side-Arm mm	Content pc.
16517-211	white/red	135.0	2/0	0.60	0.40	1

GRANDWAVE COD & POLLACK RIG

Powerful paternoster rig made with real fish skin for catching cod and coalfish in Norway.

The rotating bead prevents tangling during the fight and thus the rig can be reused many fishing days. The rotating bead is made of special ABS plastic and resists even toughest strains. The fight with and the landing of powerful big cods and coalfish will cause no problems.

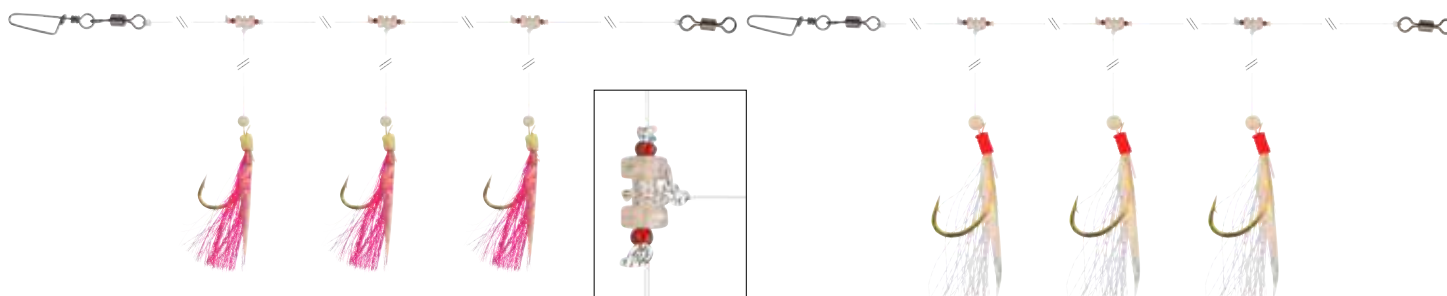

GRANDWAVE COD & POLLACK RIG

WITH FISHSKIN | PINK

Art.-No.	Color	Rig Length cm	Hook Size	Ø Line mm	Ø Side-Arm mm	Content pc.
16517-220	pink	150.0	4/0	0.90	0.80	1

GRANDWAVE COD & POLLACK RIG

WITH FISHSKIN | WHITE

Art.-No.	Color	Rig Length cm	Hook Size	Ø Line mm	Ø Side-Arm mm	Content pc.
16517-221	white	150.0	4/0	0.90	0.80	1

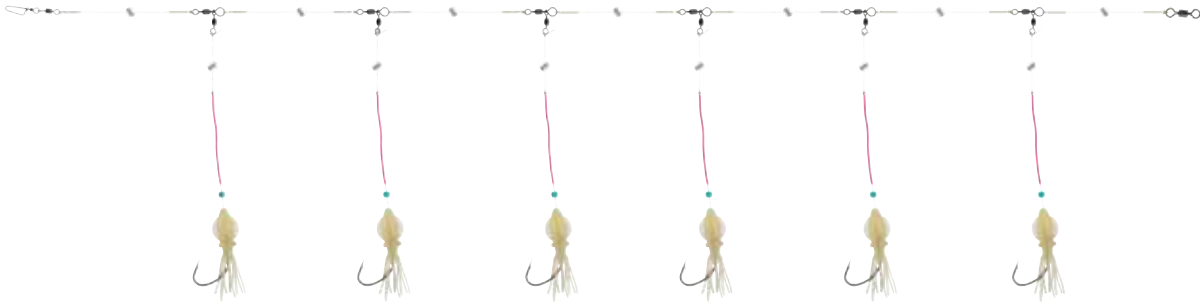

GRANDWAVE REDFISH RIG CIRCLE-HOOK

at strong currents. The thin, strong circle hooks find save grip in the redfish's mouth and reduces losses during retrieving from great depths!

Delivered with winder for an optimal storage of the rig after usage.

WHITE

This high-end rig has been developed together with our team angler Horst Hennings for fishing for big redfish in northern Norway. The special rotation swivels at both sides and the knot protection as well as the tubes at the octopus prevent tangling of the rig during sinking in great depths and

Art.-No.	Color	Rig Length cm	Hook Size	Ø Line mm	Ø Side-Arm mm	Content pc.
16517-245	white	600.0	5/0	0.80	0.70	1

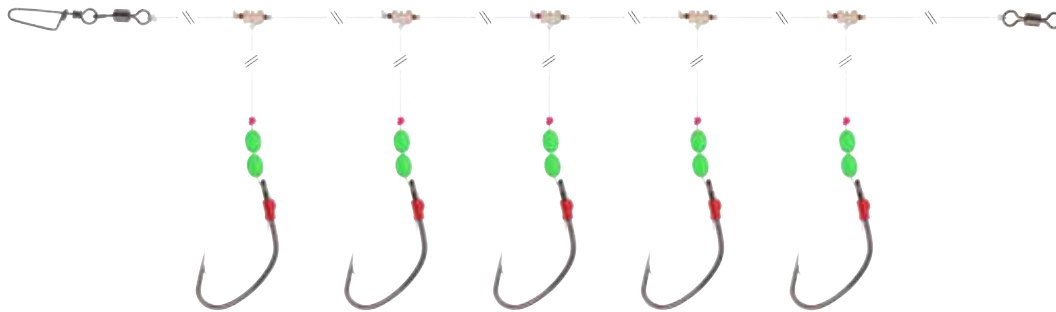

GRANDWAVE REDFISH RIG 360°

resists even toughest strains. The widely curved hooks host much fish shred and find save grip in the fish mouth. The glowing beads are an additional attraction.

WITH GLOWING BEADS

This rig is perfectly made for fishing for redfish in great depths. The rotating bead prevents tangling of the rig during sinking and lifting and thus it can be reused many fishing days. The rotating bead is made of special ABS plastic and

Art.-No.	Rig Length cm	Hook Size	Ø Line mm	Ø Side-Arm mm	Content pc.
16517-250	500.0	5/0	0.70	0.60	1

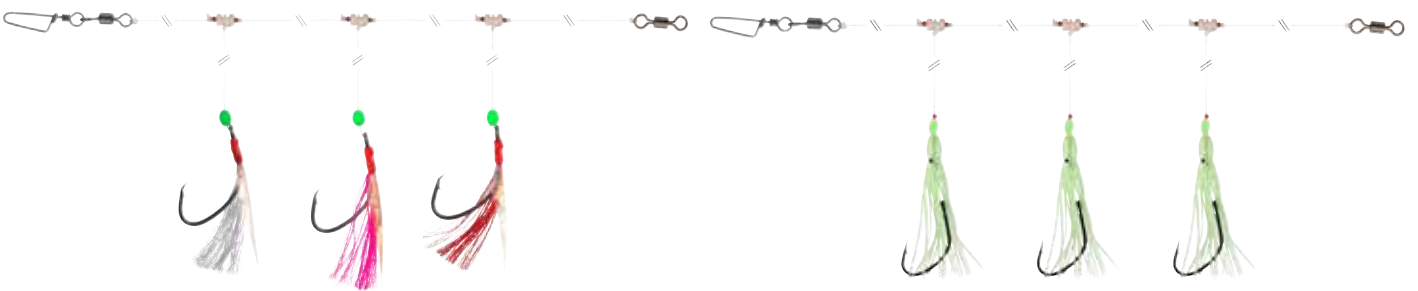

GRANDWAVE COD & POLLACK RIG

GRANDWAVE COD & POLLACK RIG

WITH FEATHERS | RED / WHITE / PINK

GLOW OCTOPUS

Extra-strong paternoster rig made with real fish skin for catching cod and coalfish in northern Norway. The rotating bead prevents tangling during the fight and thus the rig can be reused many fishing days. The rotating bead is made of special ABS plastic and resists even toughest strains. The fight with and the landing of powerful big cods and coalfish will cause no problems.

This rig with strong hooks can be fished solo or with pieces of fish bait. Ideal for Norway! The rotating bead prevents tangling during the fight and thus the rig can be reused many fishing days. The rotating bead is made of special ABS plastic and resists even toughest strains. The fight with and the landing of powerful big cods and coalfish will cause no problems.

Art.-No.	Color	Rig Length cm	Hook Size	Ø Line mm	Ø Side-Arm mm	Content pc.
16517-225	red/white/pink	135.0	5/0	0.70	0.60	1

Art.-No.	Color	Rig Length cm	Hook Size	Ø Line mm	Ø Side-Arm mm	Content pc.
16517-240	glow octopus	150.0	7/0	0.70	0.70	1

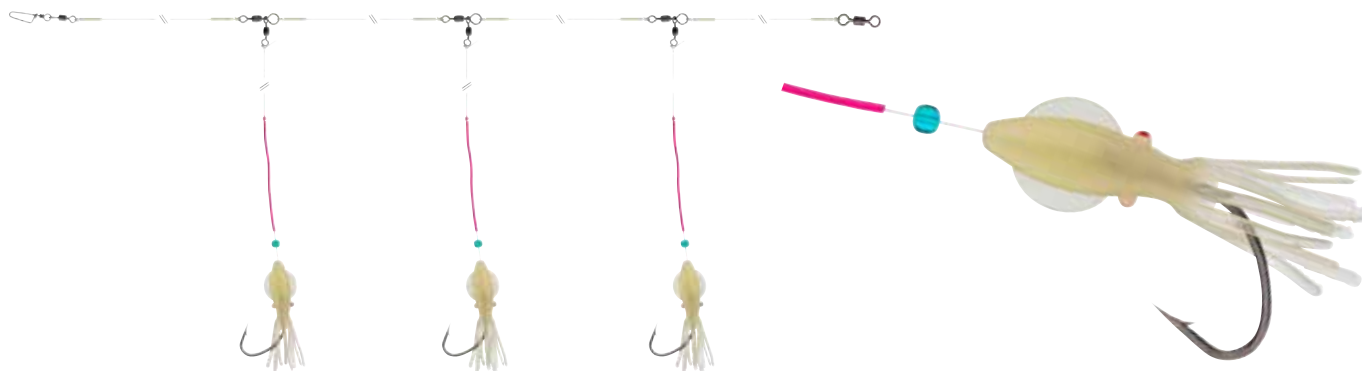

GRANDWAVE DEADBAIT RIG

SUPER-STRONG | WHITE

This rig is perfectly made for fishing for hake, cod and coalfish. Perfect for middle and northern Norway!
The big hooks are perfect for natural bait and prevent losses during the fight. The special rotation swivels at the sides and the knot protection as well as the tubes at the

octopus prevent tangling of the rig during sinking in great depths. Delivered with winder for an optimal storage of the rig after usage.

Art.-No.	Color	Rig Length cm	Hook Size	Ø Line mm	Ø Side-Arm mm	Content pc.
16517-255	white	300.0	5/0	0.80	0.70	1



GRANDWAVE WOLFFISH RIG RATTLIN

WITH RATTLES | LIGHT GREEN

The GrandWave Rattlin rig has especially been developed for catching wolffish. The rattles produce additional attractions, which tempt the wolffish to attacks. The rig should be presented vividly at the ground to produce loud noise. The special rotation swivels at both sides and the knot protection as well as the tubes at the

octopus prevent tangling of the rig during sinking in great depths and at strong currents. Perfect for middle and northern Norway! The big, strong hooks are perfect for baitfish and other natural baits. Delivered with winder for an optimal storage of the rig after usage.

Art.-No.	Color	Rig Length cm	Hook Size	Ø Line mm	Ø Side-Arm mm	Content pc.
16517-260	light green	150.0	5/0	0.80	0.70	1

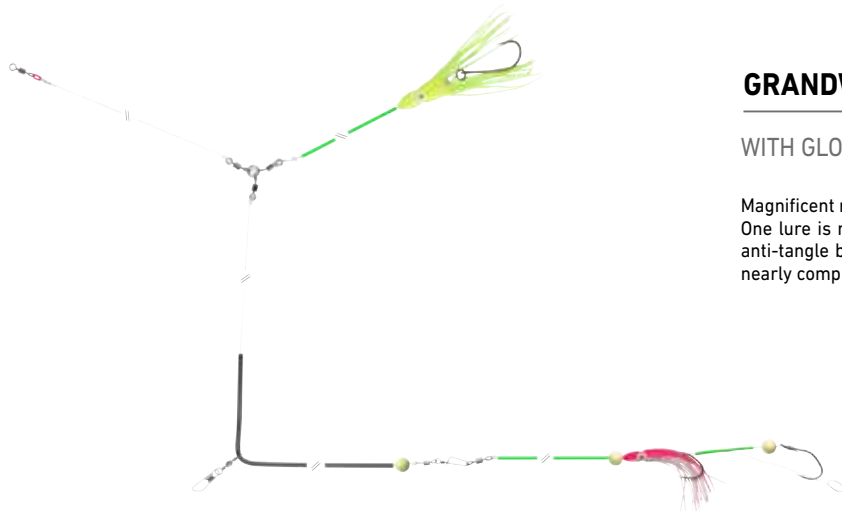

GRANDWAVE LENG ANTI-TANGLE BOOM RIG

WITH GLOW TUBE

Magnificent rig for catching ling and cusk – developed by Horst Hennings. One lure is rigged straight above the lead, another follows the lead. The extra-long anti-tangle boom and the Glow tube prevent tangling of the rig during sinking down nearly completely. Perfect for fishing in great depths.

Art.-No.	Hook Size	Ø Line mm	Content pc.
16517-265	8/0	1.00	1

GRANDWAVE

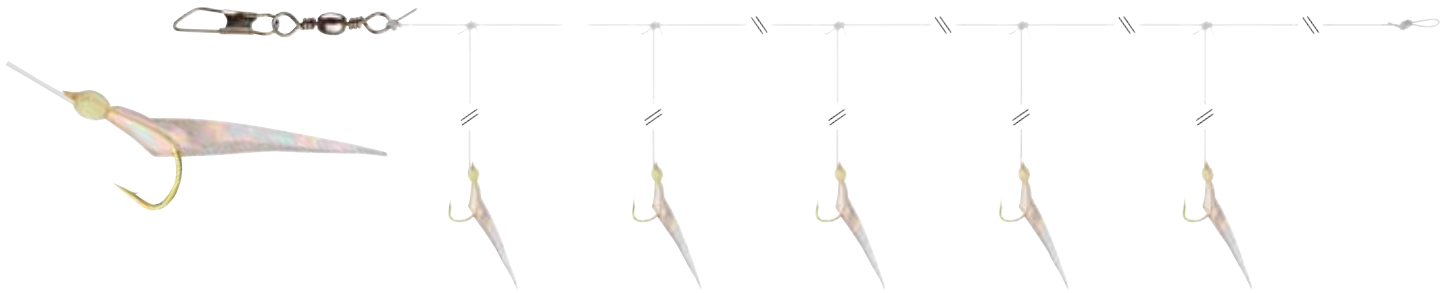

GRANDWAVE HERRING RIG

WITH FISHSKIN | GLOW

Classical herring rig with real fish skin and glow-bead. Ideal for catching herrings at the Baltic Sea.

Art.-No.	Color	Rig Length cm	Hook Size	Ø Line mm	Ø Side-Arm mm	Content pc.
16517-235	glow	135.0	10	0.40	0.30	1

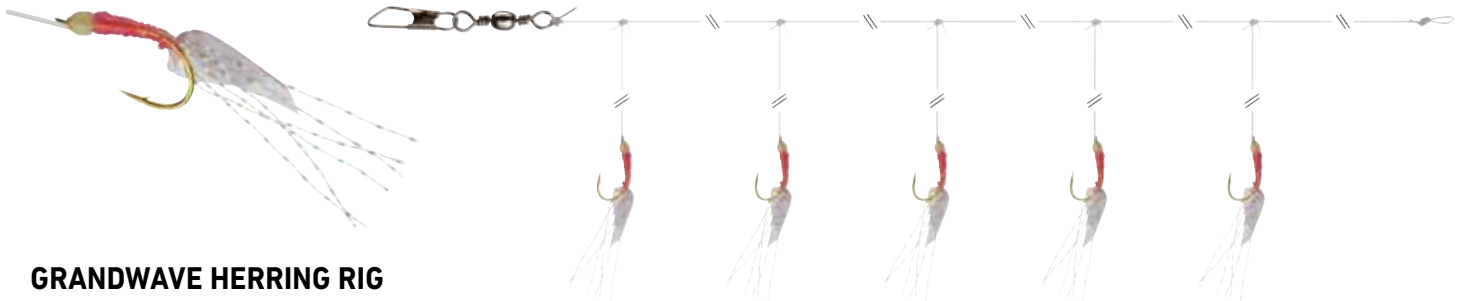

GRANDWAVE HERRING RIG

PINK-GLOW

Classical silicone herring rig with glow-bead. Ideal for catching herrings at the Baltic Sea.

Art.-No.	Color	Rig Length cm	Hook Size	Ø Line mm	Ø Side-Arm mm	Content pc.
16517-236	pink glow	135.0	10	0.40	0.30	1

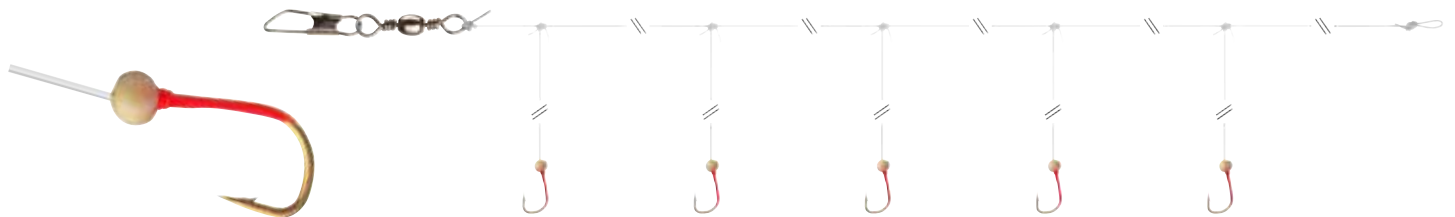

GRANDWAVE HERRING RIG MICRO

SUPER-FINE

Extremely fine rig with little hooks – ideal when herrings are not motivated for hunting and only eat small bait. Also ideal for catching sandeels as bait fish.

Art.-No.	Rig Length cm	Hook Size	Ø Line mm	Ø Side-Arm mm	Content pc.
16517-237	135.0	14	0.26	0.20	1



SUPPLY RANGE 2025





SWIVELS & SNAPS



TOURNAMENT D-SNAP SWIVEL D

SWIVEL | TYPE D-SNAP

The popular stainless steel D-Snap is also available with adjunct swivel. Perfect for plugs and jigheads. The broadly bent shape ensures a trouble-free lure action.

Art.-No.	Swivel Size	Strength kg	Content pc.
16513-000	7	13.0	7
16513-001	5	20.0	7
16513-002	4	25.0	7

TOURNAMENT D-SNAP

LURE SNAP

High-end snap made of spring steel for jigheads and plugs. Thanks to the wide curve the action of plugs is optimized.

Art.-No.	Swivel Size	Strength kg	Content pc.
16512-000	S	13.0	10
16512-001	M	20.0	10
16512-002	L	25.0	10



TOURNAMENT D-SNAP SWIVEL W

SWIVEL | TYPE W-SNAP

The extreme strong stainless steel W-Snap is also available with adjunct swivel. The broad shape is perfect for usage with plugs and jigheads and cares for a trouble-free action.

Art.-No.	Swivel Size	Strength kg	Content pc.
16513-200	7	9.0	7
16513-201	5	20.0	7
16513-202	4	32.0	7



TOURNAMENT W-SNAP

LURE SNAP

Very strong wide radius snap made of spring steel. Perfect for fishing with plugs and jigs. The wide radius cares for a freely action of plugs. The size L is additionally perfectly suited for jerkbaiting and large trolling plugs.

Art.-No.	Swivel Size	Length mm	Strength kg	Content pc.
16512-200	S	9	9.0	10
16512-201	M	12	20.0	10
16512-202	L	16	32.0	10



NO KNOT CONNECTOR

KNOTLESS SYSTEM

For a knotless connection of braided lines to swivels. Simply clip-in the swivel. By using the no knot connector you retain almost 100% of the linear strength!

Art.-No.	Swivel Size	Strength kg	Content pc.
14905-001	S	7.0	10
14905-000	M	12.0	10



EGG SNAP SWIVEL

SWIVEL

Premium Japan-style swivel. The extremely wide curve especially supports the action of plugs. Better catches are the consequence.

Perfect for light to medium-heavy fishing with shads and plugs.

Art.-No.	Swivel Size	Strength kg	Content pc.
14905-708	8	7.0	10
14905-704	4	15.0	10
14905-701	1	25.0	10



NO KNOT FAST LOCK SWIVEL

SWIVEL | WITH KNOTLESS CONNECTOR

Very strong snap with wide curve on a no knot connector. Perfect for fishing with plugs and shads. By using the no knot connector you retain almost 100% of the linear strength!

Art.-No.	Swivel Size	Strength kg	Content pc.
14905-010	S	7.0	8
14905-004	M	9.0	8
14905-002	L	12.0	8



FAST LOCK SWIVEL

SWIVEL

This swivel with open snap for easy clip-in is perfectly suited for mounting feeders, leads, surfcast fishing etc.

Art.-No.	Swivel Size	Strength kg	Content pc.
14905-410	10	7.0	10
14905-406	6	13.0	10
14905-402	2	18.0	10
14905-401	1	33.0	10
14905-400	1/0	42.0	10



EGG SNAP

LURE SNAP

Premium Japan-style snap. The extremely wide curve especially supports the action of plugs. Better catches are the consequence.

Perfect for light to medium-heavy fishing.

Art.-No.	Swivel Size	Strength kg	Content pc.
14905-608	8	7.0	10
14905-604	4	15.0	10
14905-601	1	25.0	10



FAST ATTACH SNAP

SWIVEL WITH CLIP SNAP

This swivel with open snap for easy clip-in is perfectly suited for mounting feeders, leads, surfcast fishing etc.

Art.-No.	Swivel Size	Strength kg	Content pc.
14905-802	S	12.0	10
14905-801	M	14.0	10
14905-800	L	22.0	10



FAST LOCK SNAP

LURE SNAP

Premium strong snap with wide curve. Perfect for fishing with shads and plugs. The wide curve enables a vivid lure action.

Art.-No.	Swivel Size	Strength kg	Content pc.
14905-510	10	7.0	10
14905-506	6	13.0	10
14905-502	2	18.0	10
14905-501	1	25.0	10



SUPER SAFE LURE SWIVEL TYPE II

SWIVEL WITH SAFETY SNAP | EXTRA-STRONG

This extremely strong and premium swivel is especially suited for fishing with large shads, plugs etc. – thanks to the special design, opening up under strain is almost impossible.

Scandinavian fishermen trust this type of swivel since long time ago for fishing for large pikes and zanders.

Art.-No.	Swivel Size	Strength kg	Content pc.
14905-304	4	10.0	10
14905-302	2	28.0	10
14905-301	1/0	55.0	8
14905-300	2/0	70.0	7



EASY SNAP SWIVEL

SWIVEL

Classic swivel, which can be opened fast and easy. Perfect for fishing with natural baits etc.

Art.-No.	Swivel Size	Strength kg	Content pc.
14905-212	12	8.0	10
14905-208	8	12.0	10
14905-204	4	16.0	10
14905-202	2	22.0	10



EASY ROLL SWIVEL

ROLLING SWIVEL

Premium easy rolling swivel with enormous linear strength.

Art.-No.	Swivel Size	Strength kg	Content pc.
14905-108	8	19.0	10
14905-106	6	30.0	10
14905-104	4	35.0	8
14905-102	2	43.0	8



TOURNAMENT SPLIT RING

FLATTENED SPLIT RING

Premium quality and reliable split rings made of stainless steel with high breaking strength. You will find the proper size for almost every fishing technique within this range. Made in Japan!

Art.-No.	Ø mm	Strength kg	Content pc.
16520-001	4.7	5.4	20
16520-002	5.4	8.8	18
16520-003	6.1	12.6	16
16520-004	7.1	27.9	14
16520-005	8.4	59.8	12
16520-006	10.4	64.9	10

TOURNAMENT D'JIG JIGHEAD

JIGHEAD | ROUND | WITH SAQSAS HOOK

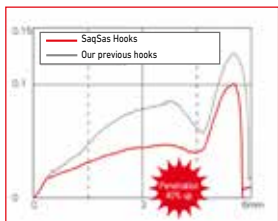

Art.-No.	Hook Size	Weight g	Content pc.
16524-205	2/0	5.0	3
16524-207	2/0	7.5	3
16524-210	2/0	10.0	3
16524-215	2/0	15.0	3
16524-220	2/0	20.0	2
16524-230	2/0	30.0	2
16524-405	4/0	5.0	3
16524-407	4/0	7.5	3
16524-410	4/0	10.0	3
16524-415	4/0	15.0	3
16524-420	4/0	20.0	2
16524-430	4/0	30.0	2

With the D-Jig jigheads DAIWA presents a series of diverse jigheads of premium quality, which cover nearly all fields of application at shad fishing. The special lure holder at the hook's shank ensures an optimal fitting of the soft plastic lure and reduces lure damages, which are usual when using conventional jigheads with lead fixing spike. Equipped with ultra-sharp SaqSas hook.

SNELLED HOOKS

TOURNAMENT SNELLED HOOKS

With the Tournament hooks we offer you a complete range of snelled hooks from Japan.

Our focus lies on the maintenance of our high quality standards – every mounted hook is individually checked for its tensile and tearing strength. Only premium Japan leader materials are used.

A real premium product made by DAIWA!



TOURNAMENT EEL HOOKS

HOOK COLOR BRONZED | LENGTH 60CM

Art.-No.	Color	Hook Size	Rig Length cm	Ø Line mm	Content pc.
14452-001	bronzed	1	60	0.35	10
14452-002	bronzed	2	60	0.35	10
14452-004	bronzed	4	60	0.33	10
14452-006	bronzed	6	60	0.30	10
14452-008	bronzed	8	60	0.25	10



TOURNAMENT FEEDER HOOKS

HOOK COLOR SILVER | LENGTH 70CM

Art.-No.	Color	Hook Size	Rig Length cm	Ø Line mm	Content pc.
14464-004	silver	4	70	0.23	10
14464-006	silver	6	70	0.23	10
14464-008	silver	8	70	0.20	10
14464-010	silver	10	70	0.20	10
14464-012	silver	12	70	0.18	10



TOURNAMENT BREAM HOOKS

HOOK COLOR RED | LENGTH 70CM

Art.-No.	Color	Hook Size	Rig Length cm	Ø Line mm	Content pc.
14456-004	red	4	70	0.23	10
14456-006	red	6	70	0.20	10
14456-008	red	8	70	0.20	10
14456-010	red	10	70	0.18	10
14456-012	red	12	70	0.16	10



TOURNAMENT FEEDER HOOKS

HOOK COLOR BLACK | LENGTH 80CM

Art.-No.	Color	Hook Size	Rig Length cm	Ø Line mm	Content pc.
14455-004	black	4	80	0.23	10
14455-006	black	6	80	0.23	10
14455-008	black	8	80	0.20	10
14455-010	black	10	80	0.18	10
14455-012	black	12	80	0.18	10



TOURNAMENT TROUT HOOKS

TOURNAMENT TROUT HOOKS

HOOK COLOR SILVER | LENGTH 60CM

HOOK COLOR SILVER | LENGTH 120CM

Art.-No.	Color	Hook Size	Rig Length cm	Ø Line mm	Content pc.
14459-002	silver	2	60	0.25	10
14459-004	silver	4	60	0.25	10
14459-006	silver	6	60	0.23	10
14459-008	silver	8	60	0.20	10
14459-010	silver	10	60	0.18	10

Art.-No.	Color	Hook Size	Rig Length cm	Ø Line mm	Content pc.
14460-002	silver	2	120	0.25	10
14460-004	silver	4	120	0.25	10
14460-006	silver	6	120	0.23	10
14460-008	silver	8	120	0.20	10
14460-010	silver	10	120	0.18	10



TOURNAMENT CARP HOOKS

TOURNAMENT MAGGOT HOOKS

HOOK COLOR BLACK | LENGTH 60CM

HOOK COLOR RED | LENGTH 50CM

Art.-No.	Color	Hook Size	Rig Length cm	Ø Line mm	Content pc.
14450-001	black	1	60	0.33	10
14450-002	black	2	60	0.30	10
14450-004	black	4	60	0.25	10
14450-006	black	6	60	0.25	10
14450-008	black	8	60	0.23	10

Art.-No.	Color	Hook Size	Rig Length cm	Ø Line mm	Content pc.
14463-010	red	10	50	0.16	10
14463-012	red	12	50	0.14	10
14463-014	red	14	50	0.12	10
14463-016	red	16	50	0.10	10



TOURNAMENT CORN HOOKS

HOOK COLOR GOLD | LENGTH 60CM

Art.-No.	Color	Hook Size	Rig Length cm	Ø Line mm	Content pc.
14454-001	gold	1	60	0.33	10
14454-002	gold	2	60	0.03	10
14454-004	gold	4	60	0.25	10
14454-006	gold	6	60	0.25	10
14454-008	gold	8	60	0.23	10



TOURNAMENT COMPETITION HOOKS

HOOK COLOR SILVER | LENGTH 40CM

Art.-No.	Color	Hook Size	Rig Length cm	Ø Line mm	Content pc.
14457-010	silver	10	40	0.14	10
14457-012	silver	12	40	0.14	10
14457-014	silver	14	40	0.12	10
14457-016	silver	16	40	0.10	10
14457-018	silver	18	40	0.10	10



TOURNAMENT SBIROLINO HOOKS

HOOK COLOR RED | LENGTH 250CM

Art.-No.	Color	Hook Size	Rig Length cm	Ø Line mm	Content pc.
14461-002	red	2	250	0.25	10
14461-004	red	4	250	0.23	10
14461-006	red	6	250	0.20	10
14461-008	red	8	250	0.20	10
14461-010	red	10	250	0.18	10



TOURNAMENT ROACH HOOKS

HOOK COLOR SILVER | LENGTH 60CM

Art.-No.	Color	Hook Size	Rig Length cm	Ø Line mm	Content pc.
14458-010	silver	10	60	0.16	10
14458-012	silver	12	60	0.14	10
14458-014	silver	14	60	0.12	10
14458-016	silver	16	60	0.10	10



TOURNAMENT WORM HOOKS

HOOK COLOR BRONZED | LENGTH 60CM

Art.-No.	Color	Hook Size	Rig Length cm	Ø Line mm	Content pc.
14453-001	bronzed	1	60	0.35	10
14453-002	bronzed	2	60	0.35	10
14453-004	bronzed	4	60	0.33	10
14453-006	bronzed	6	60	0.30	10
14453-008	bronzed	8	60	0.25	10
14453-010	bronzed	10	60	0.25	10



TOURNAMENT ZANDER HOOKS

HOOK COLOR SILVER | LENGTH 70CM

Art.-No.	Color	Hook Size	Rig Length cm	Ø Line mm	Content pc.
14462-200	silver	2/0	70	0.33	10
14462-100	silver	1/0	70	0.30	10
14462-001	silver	1	70	0.30	10
14462-002	silver	2	70	0.25	10
14462-004	silver	4	70	0.23	10



DAIWA SOKKOU KNOT TOOL

LINE CONNECTOR

Easy – fast and light – Sokkou!

Sokkou – the Japanese expression for fast and easy – and that's what this small tool is all about.

With the Sokkou knot tool you can tie knots between monofilament leader and braided main line within seconds. With some experience you can use this tool even with closed eyes or in the dark. Usually, at cold weather or wind the connection between leader and braided main line can only be tied with some experience or much effort. With the Sokkou knot tool this connection no longer represents a problem. An indispensable tool, which does not miss in any tackle box of our team anglers.

Applicable for mono leaders up to ca. 0.40mm and braided main lines up to ca. 0.25mm.

Detailed manual on the back of the packaging or as film via internet, respectively.

Art.-No.	Color	Content pc.
15800-205	yellow	1

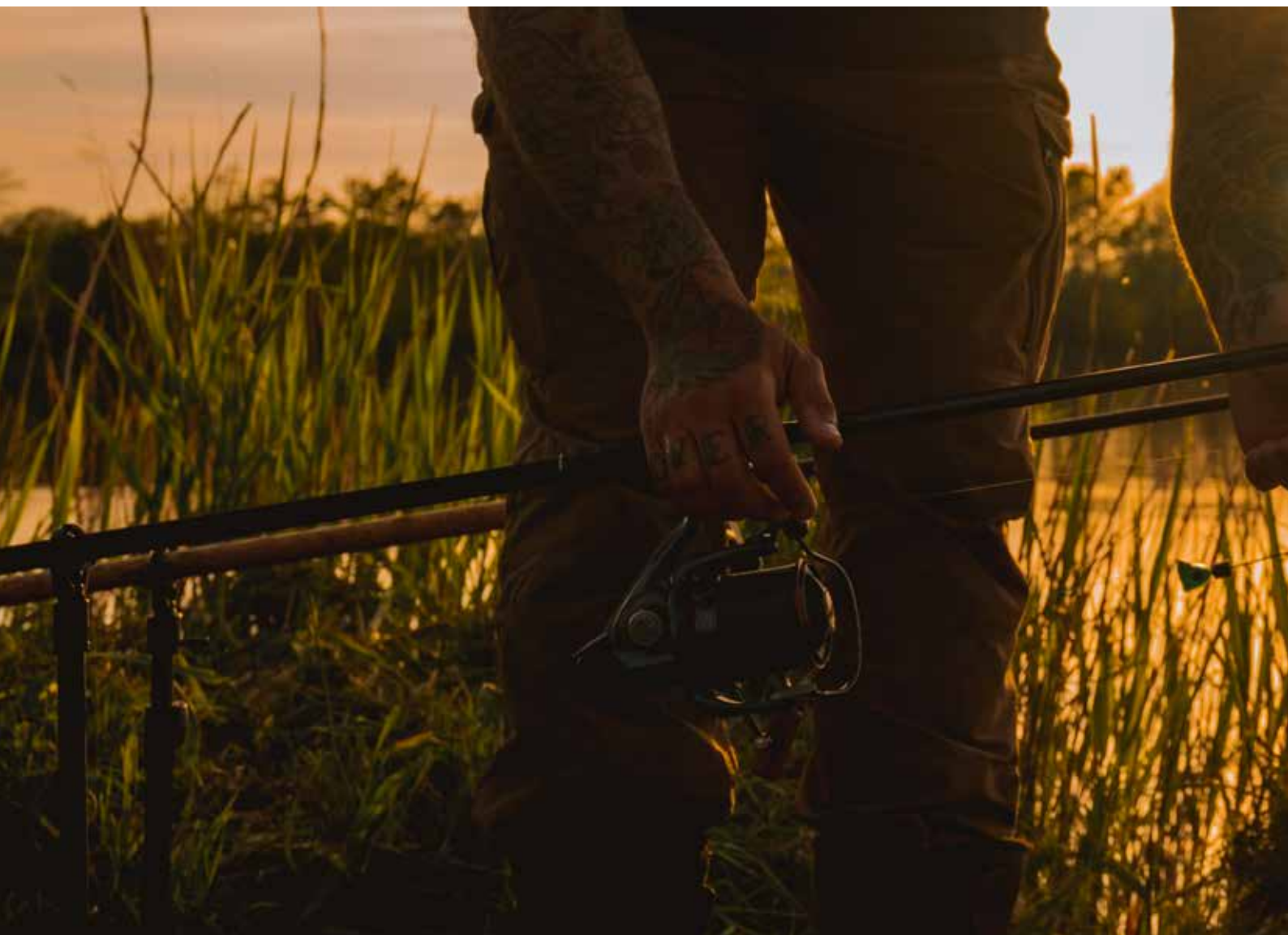

TOOLS & EQUIPMENT

DAIWA D-VEC MULTI ADJUST CARBON TELE HANDLE

NEW

LANDING NET HANDLE

This extra-long and powerful landing net pole with 3k woven carbon surface in 4.2m length is easy to transport and stow thanks to the short sections. The unique screw nut features multi threads to be able to adjust the length twist less to your individual fishing conditions and needs.
With English thread.



Art.-No.	Color Handle	Length cm	Handle L. cm	Closed L. cm	Sect.	Weight g
15810-420	carbon	420	85-420	85	6	290



DAIWA D-VEC FLOATING WADING NET

NEW

WADING NET

This floating wading net was specially designed for Seatrout fishing from the shore – but is also suitable for any wading styles in streams and rivers. The rubberized mesh features a „no-hook-tangle” function thanks to its special construction. A bushing at the front can be attached to any snap or carabiner and safely placed at your back. An elastic strap at the EVA handle gives additional security during landing and handling.



Art.-No.	Color Handle	Color Net	Length cm	Handle L. cm	Closed L. cm	Size cm	Net Depth cm	Mesh mm	Weight g
15810-520	black	black	73	18	73	55x45	40	10x10	280



DAIWA TAPELINE

Measuring tape with press button, displaying centimeters and inches (150cm/60inch.). Coated with water-repellent material in carbon fiber design.

Material: PVC

Art.-No.	Scale L. cm	Scale L. inch	Content pc.
15809-000	150	60	1

DAIWA TOWEL

WITH VELCRO STRAP



This small but useful towel can easily be attached to the belt or trousers by a hook and loop fastener. Perfect for drying and cleaning of fingers. Machine washable.

Material: polyester

Art.-No.	Size cm	Content pc.
15803-060	28x20	1

DAIWA MINI SPLITRING PLIERS



Especially when dealing with small plugs and spoons of 30mm – 50mm, normal split ring pliers usually are too coarse for the tiny split rings. The DAIWA mini split ring pliers feature very fine jaws, which allow opening of smallest split rings without damaging them.

Art.-No.	Length cm	Content pc.
16510-100	12.7	1



DAIWA LANYARD

WITH MEASURING TAPE



Thanks to this lanyard you have a measuring tape with you every time.

Material: polyester

Art.-No.	Scale L. cm	Content pc.
15803-001	100	1

DAIWA D'BRAID SCISSORS

FOR BRAIDED AND MONOFILAMENT LINES



Premium scissors, which reliably cut mono leaders as well as thin braided lines.

Art.-No.	Length cm	Content pc.
15803-070	11.0	1

DAIWA D'LINE CLIPPER

FOR MONOFILAMENT LINES



Small stainless steel line clipper for cutting mono leaders etc.

Art.-No.	Length cm	Content pc.
15803-080	6.0	1

DAIWA DIGITAL T-BAR SCALE

WEIGHING RANGE UP TO 50KG

Premium and very precise scale. Scale range up to 50kg – can be changed from lbs to kg. The T-bar holder is very handy and offers an easy handling even under heavy loads. The upper eyelet can be hooked in a tripod. With integrated thermometers and memory function.



Art.-No.	Weighing Area (max.) kg	Content pc.
18860-251	50	1

DAIWA LURE & STINGER BOX

TWO-SIDED | WITH SILICONE SEALING



Within this small box with slit EVA board, stinger systems as well as mini-spoons and plugs etc. can be stored conveniently.

Thanks to the silicone sealed lid your small parts remain save and dry even during rain.

Art.-No.	Size cm	Content pc.
15809-805	19x11x4	1



TAYAMA

BAGS & BOXES 2025







BAGS & ACCESSORIES

DAIWA NEOPRENE ROD STRAP SET

WITH GUIDE SLOT

Premium rod belt which is made of extremely flexible neoprene material. The belt's slot can easily be pulled over a rod's guide – thus the strap is secured non-slipping. Especially for spin, match and feeder rods.

Material: 90% neoprene, 10% nylon



Art.-No.	Size	Content Set pc.
15803-050	M	2

DAIWA NEOPRENE ROD BELT SET

WITH PROTECTION CAP

Premium rod belt set with extra-cap for the protection of the tip. Ideally suited for transportation of premium rods.

Material: neoprene



Art.-No.	Content Set pc.
15801-000	2

DAIWA NEOPRENE REEL COVER

Premium neoprene pouch for spinning reels available in three sizes as well as for baitcasting reels. Thanks to its design, the pouch can also be used with mounted reels – perfect for a safe transport during long car rides.

Material: 90% neoprene, 10% nylon



DAIWA NEOPRENE REEL COVER

FOR BAITCASTING REELS

This neoprene reel bag is intended for the use with baitcasting reels.

Art.-No.	Size cm	Version	Content pc.
15802-025	12x12.5	for baitcasting reels	1



DAIWA NEOPRENE REEL COVER

FOR SPINNING REELS

Size S fits for reels up to size 2500
 Size M fits for reels from size 2500 to size 4000
 Size L fits for reels from size 4500 to size 8000

Art.-No.	Size	Size cm	Version	Content pc.
15802-010	S	17x15	for reels up to sz. 2500	1
15802-015	M	19x16	for reels sz. 2500-4000	1
15802-020	L	23.5x18	for reels sz. 4500-8000	1

DAIWA RIG POUCH

Rig bag for surf and sea leaders, wire leaders etc. Equipped with 10 removable single pockets.

Material: PVC



Art.-No.	Size cm
15800-001	17x16x5



DAIWA FIGHTING BELT

The DAIWA harness is appropriate for sea fishing and for catfish fishing. Thanks to its construction all kind of rods can be used – a gimbal is not necessary. Very lightweight and with minimal storage requirements – perfect for travelling by plane.

Material: Harness PVC; Transportation bag nylon

Art.-No.	Size cm
15800-005	17x21x7

DAIWA LANDING NET HANDLE

TELESKOPISCH | SHORT-SECTIONED

Premium landing net handle made of carbon fiber with extremely short sections. Due to the short sections, this landing net handle can be transported easily in your fishing bag or rod bag. Perfectly suited for waterways and port areas when the surface is far below the fishing spot.

Material: carbon fiber

Art.-No.	Handle L. cm	Closed L. cm	Sect.	Weight g
11920-360	360	46	10	510
11920-420	420	72	7	530
11920-535	535	72	9	590



DAIWA D-VEC WAVELOCK UMBRELLA

ROUND | ARC MEASURE 250CM

The DAIWA D-VEC Wavelock umbrella with 2.5m is extremely robust and offers enduring rain protection thanks to its thick and strong wavelock material. All seams have been stitched twice and taped afterwards – thus water entry via the seams is prevented even at very strong rain. If you are looking for a very strong and safe umbrella, the DAIWA Wavelock umbrella is the perfect choice.

Material: Umbrella cover polyester



Art.-No.	Size cm
18801-250	250



DAIWA EVA BAG

The DAIWA multiloader is intended for the safe and dry transportation of supplies and small parts as well as clothes, shoes etc. Additionally you easily can transport your catch with this bag!

The material is 100% waterproof and the bag can be conveniently folded for space-saving transportation. The anti-smell material can be cleaned easily.

Available in two sizes.

Material: Bag EVA

MULTI LOADER |
FOLDABLE | M-SIZE



Art.-No.	Size	Size cm
15809-125	M	36x25x23

MULTI LOADER |
FOLDABLE | L-SIZE



Art.-No.	Size	Size cm
15809-145	L	45x29x28

DAIWA EVA BAITFISH BUCKET

FOLDABLE | WITH MESH INSERT



The foldable EVA baitfish bucket from DAIWA convinces with elaborate details. The mesh insert can easily be taken out of the main compartment and placed in the water. Thanks to the mesh the baitfish constantly receive fresh water. At removing the mesh insert from the bucket the bottom edge of the insert retains a certain amount of water, thus perfectly protecting your baitfish. The bucket features a small outer pocket for housing an aeration pump.

Can be conveniently folded for easy transportation.

Delivered with 8m rope.

Material: Bucket EVA

Art.-No.	Size cm
15809-110	36x30

DAIWA EVA BUCKET

FOLDABLE

This small and smart foldable fishing bucket with cord allows easy access to water. The long rope features special hand stoppers, which prevent slipping through the fingers. The upper end of the rope is equipped with a small lead, which guarantees dipping of the bucket into the water.

Material: Bucket EVA



Art.-No.	Size	Size cm
15809-120	M	23x20

DAIWA EVA BUCKET

FOLDABLE | L-SIZE

This foldable waterproof bucket from DAIWA can be used for many purposes. Perfect for mixing groundbait or storing water, for dry storage of supplies or even as basket for fly lines when fishing with streamers for pike.

Material: Bucket EVA

Art.-No.	Size	Size cm
15809-115	L	36x22

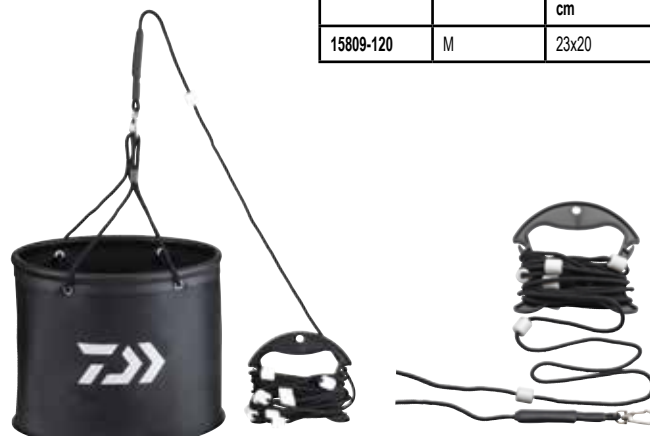

DAIWA ROD BELT

TRANSPORTATION BELT | FOR 1 MOUNTED ROD

Useful and well-priced transportation belt with shoulder strap for 2-sectioned rods. The rod can be wrapped easily into the neoprene in short time, therefore one can avoid rubbing of the two sections against each other – perfect when premium rods have to be transported.

At the water, the rod belt can be folded very small and therefore hardly needs any space.

Material: Bag 90% neoprene, 10% nylon



Art.-No.	Length cm
15809-010	78.0



DAIWA 1 ROD BAG

HARDCASE ROD HOLDALL | FOR 1 MOUNTED ROD

This rod case with woven carbon fiber design optimally protects your premium rods. Thanks to the semi-solid outer shell both rod and reel are optimally protected against external threats during transportation.

A small side pocket with hook and loop fastener offers space for a landing net handle etc. Due to the special feet, this holdall can be safely placed.

The extra-thick padded shoulder strap offers optimum handling comfort at long distances.

Depending on the length this holdall is suited for spinning rods of 2.40m to 3.00m.

Material: Bag polypropylene



Art.-No.	Length cm	Version
15809-325	145	for 1 rod up to 2.70m
15809-345	157	for 1 rod up to 3.00m

ROD STRAP SET

Classical and robust rod straps with hook and loop fastener – easy to fix. Fitting for all kind of detachable rods and can remain at the rod's handle during fishing.

Art.-No.	Size cm	Content Set pc.
15803-200	23x2	2





DAIWA ROD CASE

Depending on the model this semi-solid holdall offers space for two to three mounted rods. The shock-absorbing outer shell optimally protects your rods from external threats.

Equipped with broad shoulder strap which offers optimal handling comfort over long distances.

Material: Bag polyester, PVC coated



DAIWA 2 ROD CASE

SEMI-HARDCASE ROD HOLDALL | FOR 2 MOUNTED RODS

Art.-No.	Length cm	Version
15801-225	128	for 2 rods up to 2.40m
15801-245	145	for 2 rods up to 2.70m

DAIWA 3 ROD CASE

SEMI-HARDCASE ROD HOLDALL | FOR 3 MOUNTED RODS

Art.-No.	Length cm	Version
15801-325	128	for 3 rods up to 2.40m
15801-345	145	for 3 rods up to 2.70m

DAIWA EXTENSION 1 ROD BAG

HARDCASE ROD HOLDALL | FOR 1 MOUNTED ROD

Lightweight semi-hard holdall with carbon fiber optics and solid bottom. By the special design the holdall can be used for rigged rods from 2.10m to 3.10m length. The upper section can be adapted to the length via hook and loop fastener.

Material: Bag PVC; Inner lining polyester

Art.-No.	Size cm	Version
15808-310	130x19x10	for 1 7-10ft rod



DAIWA D-VEC GLOBAL TRAVEL WHEEL BAG

TRANSPORTATION BAG

Very premium, big and robust travel bag with 2 big compartments. Within the lower compartment, you can easily store travel rods, reels, lures etc. Due to the lateral reinforcement and a thick padding at the top, your tackle is perfectly protected. The upper compartment offers space for clothing, boots etc.

The extra big reels and the robust extendible handle, care for an easy transportation of the bag even over uneven ground. Two lateral straps can be fixed to the bag and ensure a safe storage and protection of the zipper even under heavy load. The extra big zippers are made of ABS material and don't corrode – additionally both main compartments can be locked.

Due to the length of 98cm, within this bag even travel rods can be transported (e.g. 8.6' Popper rods 3-sect.), with usually are too big for most other bags – ideal for Norway and fishing trips in warm water areas.

Material: polyester



Art.-No.	Size cm
15808-000	98x40x46



D-BOX

DAIWA TACKLE SYSTEM

D-BOX TACKLE SYSTEM

With the D-Box Tackle System, DAIWA offers a great range of premium and robust tackle boxes in diverse sizes, which are ideally suited for lures and other accessories. Due to the completely sealed lid and clip fasteners at all four sides, the content is perfectly protected against water.



D-BOX SS TACKLE SYSTEM

LURE TACKLE BOX | SMALL SHALLOW | WITH SILICONE SEALING



Art.-No.	Model	Dimensions outside cm	Weight g
14310-000	SS	21.7x16.4x3.3	240

D-BOX SR TACKLE SYSTEM

LURE TACKLE BOX | SMALL REGULAR | WITH SILICONE SEALING



Art.-No.	Model	Dimensions outside cm	Weight g
14310-005	SR	21.7x16.4x4.8	225

D-BOX SD TACKLE SYSTEM

LURE TACKLE BOX | SMALL DEEP | WITH SILICONE SEALING



Art.-No.	Model	Dimensions outside cm	Weight g
14310-010	SD	21.7x16.4x9.0	375

D-BOX MR TACKLE SYSTEM

LURE TACKLE BOX | MEDIUM REGULAR | WITH SILICONE SEALING



Art.-No.	Model	Dimensions outside cm	Weight g
14311-005	MR	26.7x16.7x4.8	260

D-BOX MS TACKLE SYSTEM

LURE TACKLE BOX | MEDIUM SHALLOW | WITH SILICONE SEALING



Art.-No.	Model	Dimensions outside cm	Weight g
14311-000	MS	26.7x16.7x3.3	275

D-BOX MD TACKLE SYSTEM

LURE TACKLE BOX | MEDIUM DEEP | WITH SILICONE SEALING



Art.-No.	Model	Dimensions outside cm	Weight g
14311-010	MD	26.7x16.7x9.0	510





D-BOX LS TACKLE SYSTEM

LURE TACKLE BOX | LARGE SHALLOW | WITH SILICONE SEALING



Art.-No.	Model	Dimensions outside cm	Weight g
14312-000	LS	34.4x21.5x3.3	465

D-BOX LR TACKLE SYSTEM

LURE TACKLE BOX | LARGE REGULAR | WITH SILICONE SEALING



Art.-No.	Model	Dimensions outside cm	Weight g
14312-005	LR	34.4x21.5x4.8	416

D-BOX LSU TACKLE SYSTEM

LURE TACKLE BOX | LARGE SHALLOW UNIVERSAL | WITH SILICONE SEALING



Art.-No.	Model	Dimensions outside cm	Weight g
14313-000	LSU	34.4x21.5x3.3	741

D-BOX LD TACKLE SYSTEM

LURE TACKLE BOX | LARGE DEEP | WITH SILICONE SEALING



Art.-No.	Model	Dimensions outside cm	Weight g
14312-010	LD	34.4x21.5x9.0	608

D-BOX SSU TACKLE SYSTEM

LURE TACKLE BOX | SMALL SHALLOW UNIVERSAL | WITH SILICONE SEALING



Art.-No.	Model	Dimensions outside cm	Weight g
14313-005	SSU	21.7x16.4x3.3	365



14313-005
14313-000

WATERPROOF SEALED UNIT CASE

These very premium tackle boxes are made of shockproof ABS material and extremely resilient. Due to the seal ring at the lid, no water can intrude and all pieces in the inside are perfectly protected against moisture and water. The boxes are delivered with fitting magnetic pads, which can easily be stuck in to further protect the content – ideal for hooks, swivels, crimps etc. The boxes' bases are constructed in a way to make it possible to connect two boxes with each other. Available in flat (green) and high (red) version. Made in Japan.



WATERPROOF SEALED UNIT CASE

3 COMPARTMENTS | WITH MAGNETIC FOIL



Art.-No.	Color	Size cm
14413-300	green smoke	11x6.5x1.3
14413-305	red smoke	11x6.5x1.8

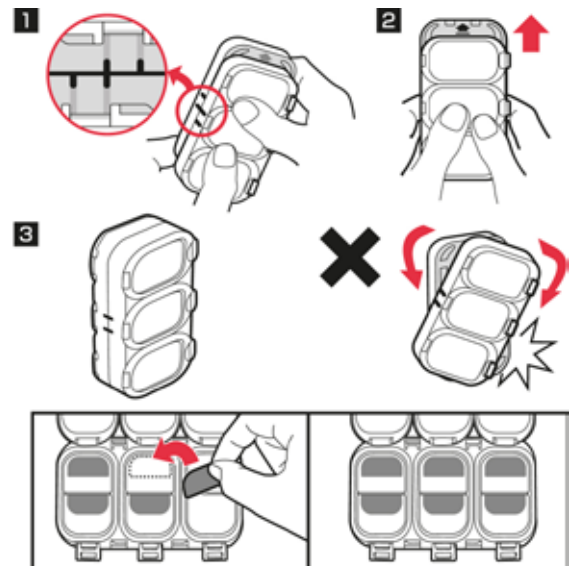

WATERPROOF SEALED UNIT CASE

6 COMPARTMENTS | WITH MAGNETIC FOIL



Art.-No.	Color	Size cm
14413-600	green smoke	11x6.5x1.3
14413-605	red smoke	11x6.5x1.8

WATERPROOF SEALED UNIT CASE

9 COMPARTMENTS | WITH MAGNETIC FOIL



Art.-No.	Color	Size cm
14413-900	green smoke	11x6.5x1.3
14413-905	red smoke	11x6.5x1.8



DAIWA D-VEC CATFISH BAG XL

NEW

The return of a legend!

This quality DAIWA bag was specially designed for the need of catfish anglers and improved in many details compared to the previous version. The robust grey Polyester material features a kind of water repellent function to avoid immediate soaking during short rainfalls and humid conditions.

The two large front pockets (26x25cm, 20x25cm) accommodate tackle boxes, bite indicators, etc. The upper main compartment features a detachable EVA Rig board for catfish rigs and a inner hard top to avoid hook tips penetrating the lid. The lower main compartment offers huge space for various TT like reels, spools, etc. and can be adjusted exactly to your needs by the inner dividers. In addition, three individual small inner pouches (30x16x10cm, 18x15x10cm, 15x10x10cm) are included that will store various bit's n pieces like heavy leads, swivels, etc.. This provides easy overview and save organization of all your needed catfish belongings. The inside of the lid features elastic straps to stow and store clonking woods, long nose pliers, etc.

The rubberized anti-slip bottom is waterproof and will eliminate soaking moisture from wet grounds.

The extra-large ABS zippers will not corrode and can cope with heavy weights. Comes with padded, adjustable shoulder strap and heavy load carrying handle.

Material: Bag polyester; Bottom PVC

Art.-No.	Size cm
15840-000	53x32x19



DAIWA D-VEC SHOULDER BAG

NEW

LURE BAG

Processed in high quality and economically prized!

Classic fishing shoulder bag for tackle boxes and various TT. The main compartment (30x15cm) offers space for up to 3 tackle boxes, etc. The three small front pockets (12x8cm) easily accommodate accessories like knives, pliers, etc. The two side pockets (17x13cm) take easy hold of various bits' pieces like cell phone, fishing documents and so on. The specific grey Polyester material is easy to clean and features a kind of water repellent function that will avoid fast soaking during short rainfalls. The rubberized waterproof bottom will eliminate soaking from wet grounds. Includes an adjustable shoulder strap. The inner compartment is PVC lined and can easily be cleaned.

Material: Coating PVC; Bottom PVC; Material polyester

Art.-No.	Size cm
15840-001	39x23x18

DAIWA D-VEC 1 ROD PROTECTION STIFF BAG

NEW

ROD HOLDALL | FOR 1 MOUNTED ROD

Semi-hard case rod holdall for one fully assembled rod. Perfect to protect valuable and fragile Spinning- and Feeder rods. Made by water repellent material with rubberized bottom to avoid soaking from wet ground. Features strong, extra-large, corrosion free double ABS zippers to provide fast and easy access. Comes with carrying handle and padded, adjustable shoulder strap. An additional top eyelet allows hanging function for storage.

Material: polyester

Art.-No.	Length cm
15843-130	130
15843-145	145
15843-155	155

DAIWA D-VEC 3 ROD BAG

NEW

ROD HOLDALL | FOR 3 MOUNTED ROD

Top price quality performance!

Classic thick padded holdall for three fully assembled rods. The long front pocket with oversized zipper for easy access accommodates an umbrella or bank ware. Features padded rucksack-style shoulder straps and carrying handle. Two eyelets on the top and bottom allow hanging storage. Made by water repellent material with rubberized bottom to avoid soaking from wet ground. Features strong, extra-large, corrosion free ABS zippers.

Material: polyester

Art.-No.	Length cm
15841-110	110
15841-130	130
15841-155	155
15841-175	175



DAIWA D-VEC HIP BAG

NEW

HIP BAG

Conventional lightweight Hip Bag with lot's of space for all your belongings. The Polyester material features a kind of water repellent function to avoid immediate soaking during short rainfalls and humid conditions. The large main compartment (23x12x8cm) and the backside compartment (23x13x5cm) each accommodate a small tackle box for lures and accessories. A heavy padded separate side pocket was specially designed to hold and protect cell phones. An additional separate side pocket (18x18cm) and an additional zipped front pocket provide additional space for all your belongings. Comes with adjustable belt.

Material: polyester

Art.-No.	Size cm
15840-004	23x13x17

DAIWA D-VEC RUCKSACK

NEW

BACKPACK

Extra-large rucksack with arrrd. 30l capacity and cooling compartment on the bottom. Both side pockets safely accommodate mounted rods for transport. The backside mesh provides good air circulation and the padded shoulder straps offer outstanding wearing comfort. A separate small front pocket easily holds small accessories and belongings.

The inner room can be easily wiped clean. The overlapping lid provides good protection against rainfalls and splashes. The rubberized bottom is waterproof and will eliminate soaking moisture from wet grounds.

Material: Bottom PVC;
Outer material polyester

Art.-No.	Size cm	Volume l
15840-002	35x55x20	30



DAIWA D-VEC DOCUMENT POUCH

NEW

This quality DAIWA document pouch will easily hold and protect your fishing documents. Features a water repellent zipper and inner pen holder. Made by water repellent material.

Top price-quality ratio!

Material: polyester

Art.-No.	Size cm
15840-003	15x20



DAIWA D-VEC PADDED 1 ROD SLEEVE

NEW

ROD HOLDALL | FOR 1 MOUNTED ROD

Thick padded quality rod sleeve for one fully assembled rod. Perfect to protect Spinning- and Feeder Rods. Made by water repellent material with rubberized bottom to avoid soaking from wet ground. Features strong, extra-large, corrosion free ABS zippers. Comes with carrying handle and padded adjustable shoulder strap.

Material: polyester

Art.-No.	Length cm
15842-130	130
15842-145	145
15842-155	155

DAIWA D-VEC REEL PROTECTION CASE

NEW

This quality reel case with hard frame provides ideal protection for your valuable reels during transport and for storage. Perfect for long distance travels with the airplane. The inner segments can be individually adjusted according to your reel size. The extra large and tough ABS zipper is corrosion free. Made by water repellent material.

Available in two sizes:

L: for 2-3 Big Pit reels or 4-6 Spinning reels.

M: for 4 Spinning reels or up to 6 Baitcast reels.

Material: polyester

Art.-No.	Size cm
15844-002	26x23x9
15844-001	36x26x14



DAIWA D-VEC RIG POUCH

NEW

RIG & LEADER BAG

Quality stiffened DAIWA Rig pouch with 10 separate inner bags. Features a non-corrosion ABS zipper. Made by water repellent material.

Material: polyester

Art.-No.	Size cm
15840-005	15x16x4



DAIWA D-VEC UNHOOKING MAT

NEW

This allrounder unhooking mat suits all fishing styles and methods. Nowadays, such mat is mandatory for many areas both for coarse and lure fishing as well. The slick and fast dry surface of this DAIWA unhooking mat can be easily cleaned and provides good fish protection. Two side buckles can be used to stick the mat on uneven and slippery grounds. The two elastic straps support easy folding and transport of this mat.

Material: polyester, water-repellent coated

Art.-No.	Size cm
15840-008	75x48





CARP PROGRAM 2025





DAIWA CARP



INFINITY SYSTEM BAGS AND TACKLE

INFINITY[®]

S Y S T E M

This concise and highly functional luggage range has been developed to suit the needs of the modern carp angler, be it for a short session or a week away. With the assistance of consultants across the EU we have closely examined what you carry, how you fish with it even how you store it in the Bivvy.

When designing the bags, we closely considered pocket sizes and depths and what tackle boxes anglers are using to ensure they will fit into the system. Each bag and pouch is either PVC or thermal lined; all easily wiped clean.

Bags also come with double carry handles and a detachable shoulder strap if distance becomes a challenge. Designed to the same height, all three new Infinity System bags can be placed under the bedchair. They also have a hard top that can be used as a work surface or place items in easy reach when fishing. Each bag also has a PVC base to stop damp when placed on the ground.

The rod holdalls have been designed with enough space for easy loading and unloading of made up rods. We have provided enough space and protection for the largest carp reels to fit in easily and safely.

INFINITY SYSTEM LUGGAGE



Product delivered without content.



Product delivered without content.

INFINITY® SYSTEM LOW LEVEL CARRYALL

SYSTEM CARP BAG

The IS Low Level Carryall is designed to be the main tackle storage unit for all carp anglers. The most popular tackle boxes fit in perfectly and also all the modular storage pouches within the Infinite system range find the proper place at this space miracle. The bag comes with a recessed hard top for prepping rigs and safely keeping small bits at hand. The PVC inner lining is easy to clean and the PVC base protects against damp via the ground.

The Low Level Carryall has three external pockets for tackle boxes, smaller EVA accessory pouches as well as banksticks, bite detector, etc. The inner compartment is designed to take four of the medium accessory pouches or two of the large cool pouches.

Ideal flexibility for short or longer fishing trips.

Equipped with detachable shoulder strap and two padded carrying handles.

Material: Outer material polyester (600D); Inner lining PVC; Bottom PVC

- Made to fit and store most popular tackle boxes and IS pouches
- Hard top that can be used as a work surface
- Fitting under most bedchairs
- Extra big external pockets for tackle boxes and buzzer bars
- Easy cleaning

Art.-No.	Size cm
18850-200	64x39x27

INFINITY® SYSTEM LOW LEVEL RUCKSACK

SYSTEM CARP BAG | WITH BACKPACK CARRYING SYSTEM

For those who want to go for more remote fishing spots, the spacious IS Low Level Rucksack offers perfect carrying comfort – even over great distances. The Rucksack is designed to match with most popular tackle boxes on the market as well as with all the modular storage pouches from the Infinite System range. This enables the angler to tailor your tackle to suit your particular individual needs when fishing. The Rucksack has been designed to fit under most bedchairs.

Featuring a recessed hard top or work surface, you will be able to place items securely on top. The PVC inner lining is easy to clean and the PVC base helps to protect against a wet or damp ground.

The Low Level Rucksack has three external pockets in a different configuration to the carryall with two long side pockets and a single smaller top pocket. They are made to fit tackle boxes and the small EVA accessory pouches, buzzer bars, etc.

The main compartment is designed to take four of the IS medium accessory pouches or two of the large cool pouches, providing you with a complete and flexible storage system.

Equipped with padded shoulder strap and padded carrying handles.

Material: Outer material polyester (600D); Inner lining PVC; Bottom PVC

- Made to fit and store most popular tackle boxes and IS pouches
- Hard top that can be used as a work surface
- Fitting under most bedchairs
- Extra big external pockets for tackle boxes and buzzer bars
- Easy cleaning

Art.-No.	Size cm
18850-300	53x50x27



INFINITY®

S Y S T E M



Product delivered without content.



INFINITY® SYSTEM BREW & OVERNIGHT COOK BAG

STORAGE BAG | FOR COOKING & CAMPING ACCESSORIES

For a secure carrying of cooking essentials on a short trip this bag is just perfect. The semi-hard lid is perfect as work surface and the PVC base prevents intruding dirt and damp when placed on the floor.

The main compartment is split into three sections to carry different items: stove, kettle and gas canister. The two inner storage compartments are both lined with a wipe clean thermal material, keeping food cool and clean. The mesh inside the lid can hold a plate if needed. The bag is supplied with an inner PVC bag to store all essential cooking items - this can also be kept separate from the main bag to assist hygiene.

Material: Bag polyester (600D); Bottom PVC

- With additional PVC bag
- Hard lid that can be used as a work surface
- Fitting under most bedchairs
- Easy cleaning

Art.-No.	Size cm
18850-400	26x26x27

INFINITY® SYSTEM EVA ACCESSORY POUCH SET

S-SIZE

Optimal accessory bags for the main bags of the Infinite series.

The set consists of one small EVA pouch and two EVA mini pouches, which are ideal for use for tackle like leads, backleads, etc. and perfectly suit into the medium accessory pouch.

The small accessory pouches feature clear lids for a quick identification of tackle items. Both EVA mini pouches are designed to fit in the pockets of the IS Low Level Carryall and IS Rucksack.

Material: Bag EVA

- Three separate EVA pouches
- Ideal for small items
- Waterproof EVA material
- Made to fit with the large IS bags

Art.-No.	Size cm	Content Set pc.
18850-010	15x10x8	3



INFINITY® SYSTEM ACCESSORY POUCH

M-SIZE

The medium version is perfect for storing most accessories like indicators, marker, etc and is designed to be used with the IS rucksack and IS Low Level carryall. The system will accommodate four pouches in the main compartment of the Low Level carryall.

Its size is the same as the best-selling accessory boxes and can be used in conjunction with this to form part of the system.

The bag is also lined with PVC so that it can easily be wiped clean.

Material: Bag polyester (600D); Inner lining PVC

- Made to be used with other IS pouches
- Four pouches will fit in IS Carryall or IS Rucksack
- Perfect in conjunction with IS EVA pouches
- PVC lining

Art.-No.	Size	Size cm
18850-050	M	25x20x10



INFINITY® EVA COOL BAG

The Cool Bag's size is similar to the EVA Tackle Container, but contains a special isolating layer within the sides to enduringly keep cool lures, foods etc. The inner walls can easily be cleaned. The stiff lid can be used as small table or pad for rigging etc.

Material: Bag EVA

Art.-No.	Size cm	Weight g	Content pc.
18885-005	42x32x26	1360	1



Product delivered without content.

INFINITY® SYSTEM ACCESSORY & COOL POUCH

WITH THERMO INSULATION | L-SIZE

The large IS accessory pouch has the same profile as the medium model but is double in height and lined with a thermal foil, making it perfect to carry additional food or bait (up to 5kg of boilies).

Within the main compartment of the rucksack or the Low Level carryall you can fit in a maximum of two large accessory bags. Like this you can prepare for the planned fishing trip and use the storage space perfectly.

Material: Bag polyester (600D)

- Made to be used with other IS pouches
- Thermal lining
- Easy cleaning

Art.-No.	Size	Size cm
18850-100	L	25x20x21



INFINITY® EVA TACKLE MANAGER

CARP BAG

Big, waterproof tackle container, made of extra thick 2mm EVA material. The robust, stiff lid can be used as pad for rigging. Both inner pockets, which are made of stiff EVA material, are fixed via clip to the frame and offer space for tackle, rigs, leads etc. thanks to their separations. Enough space remains at the bottom to securely store bite detector etc.

Material: Bag EVA

Art.-No.	Size cm	Content pc.
18885-010	42x32x26	1



INFINITY® SYSTEM ROD BAG

The rod holdalls of the Infinite System Series have been designed with enough space for easy loading and unloading of made up rods. We have provided enough space and protection for the largest carp reels to fit in easily and safely.

INFINITY® SYSTEM 3 ROD BAG

CARP ROD HOLDALL | FOR 3 MOUNTED RODS



This rod holdall has been designed to transport and store three made up rods safely – concerning the model for 10', 12' or 13ft. rods.

The bag has two internal baffles and offers enough space to protect the rods from each other when being carried.

Each bag has two open base pouches with retaining straps above to enable carrying of two additional rod sleeves. It also features a pocket on the back of the holdall to secure additional banksticks, landing net and handle.

Equipped with detachable shoulder strap and carrying handles.

Material: Bag polyester (600D)

- For 3 made up rods
- Superimposed pocket
- Detachable shoulder strap

Art.-No.	Size cm	Version
18851-010	170x25x12	for 3 10ft rods
18851-012	200x25x12	for 3 12ft rods
18851-013	215x25x12	for 3 13ft rods



INFINITY® SYSTEM MULTI LENGTH 1 ROD BAG

CARP ROD HOLDALL | FOR 1 MOUNTED ROD

This smart rod sleeve will fit 10', 12' and 13ft. rods with 50mm starter guide. The upper part of the sleeve can be adjusted to suit the length of the rod. The rod sleeve can be used to add additional rods to the three rod IS holdalls, making them carry additional rods if needed.

Material: Bag polyester (600D)

- Made to fit 10', 12' and 13ft rods with 50mm starter guide
- Fully padded for optimal protection
- Two-part construction

Art.-No.	Size cm	Version
18851-050	200x22x12	for 1 10-13ft rod

EXTENSION CONCEPT

With the growing popularity of extendable 9ft. and 10ft. rods for carp fishing, DAIWA highlighted the range of rods and luggage with the 'EXTENSION' in the product code. The main advantage is the much shorter transportation and storage length.



INFINITY® SYSTEM EXTENSION 3 ROD BAG

CARP ROD HOLDALL | FOR 3 MOUNTED RODS

The IS Extension rod holdall has been designed to transport three made up Extension Carp rods safely. The holdall features two internal baffles and offers enough space to protect the rods from each other during transportation. The holdall also provides the option to mount two additional outer rod sleeves. It also features a pocket on the back of the holdall to secure additional banksticks, landing net and handle. Equipped with detachable shoulder strap and carrying handles.

Material: Bag polyester (600D)

- For 3 made up 9ft. or 10ft. Extension carp rods
- Superimposed pocket
- Detachable shoulder strap

Art.-No.	Size cm	Version
18851-003	130x25x12	for 3 9-10ft rods



BLACK WIDOW CARP CRADLE

NEW

UNHOOKING MAT

This oversized carp cradle in 100cm x50cm size is versatile to use and provides optimal protection for your catch. The 20cm high frames can be individually folded and prevent slipping and damaging the fish. The lid can be firmly attached by velcro. This mat can either be used completely folded down to enlarge its size or with 20cm high frame. Comes with carrying handles for easy transport. The slick surface material supports fish protection, is fast drying and can be easily cleaned.

Material: polyester (420D), water-repellent coated



Art.-No.	Color	Size cm
15840-007	army green	100x50x20



DAIWA CARP FLOATING UNHOOKING MAT

Big, waterproof, floating and padded unhooking mat for releasing within the water. The anti-smell PVC material can be cleaned easily. The unhooking mat can be closed at the top to prevent jumping out of the fish. With two eyelets for a secure fixation at the bottom.

Equipped with long carrying handle for optimal transportation at the bank.

Material: polyester, PVC coated

Art.-No.	Size cm
18860-025	100x65x22



BLACK WIDOW FREE FLOW FOLDING WEIGH SLING

FOLDABLE

Space-saving, foldable weigh sling with aluminum poles. The mesh material ensures a fast and optimal water flow and dries quickly.

Material: polyester



Art.-No.	Size cm
18860-011	115x56





INFINITY®

S Y S T E M



11990-180

11990-185



INFINITY® CARP LANDING NET

The Infinity carp landing net features very slim and lightweight carbon fiber landing net handles of 1.80m length. The shrinktube handle cares for a perfect grip. With a frame length of 105cm and a depth of 85cm, the landing net head with its soft-mesh material offers enough space also for large specimen.

Equipped with cnc machined aluminium spreader block.

INFINITY® CARP LANDING NET

WITH ONE-PIECE HANDLE

Art.-No.	Length cm	Closed L. cm	Size cm	Net Depth cm	Mesh mm	Sect.
11990-180	180	177	105x105	85	8	1

INFINITY® CARP LANDING NET

WITH TWO-PIECE HANDLE

The two-sectioned model is perfectly suited for application from the boat. For landing fish, the landing net handle can also be used as a shorter version.

Art.-No.	Length cm	Closed L. cm	Size cm	Net Depth cm	Mesh mm	Sect.
11990-185	180	88	105x105	85	8	2

BLACK WIDOW

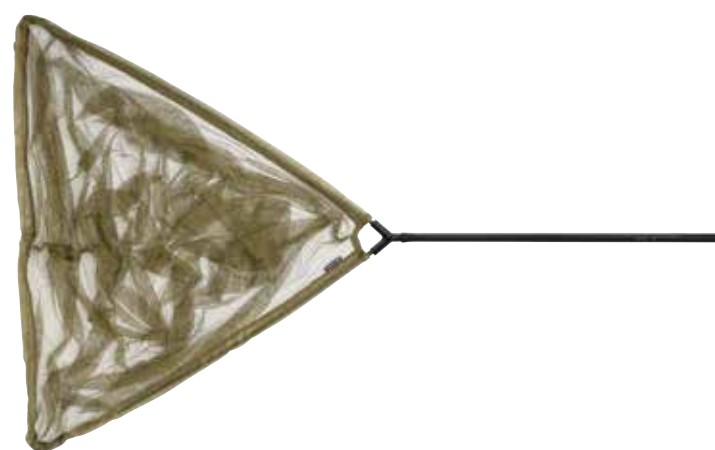

11579-180

11579-185

BLACK WIDOW CARP LANDING NET

The Black Widow carp landing net comes in two versions. The 1-piece carbon fiber landing net handle with 180cm is perfectly suited for usage from the bank. The telescopic version of 180cm can be transported space-saving and ensures safe landings from the bank as well as from the boat. The 8mm soft-mesh net has a depth of 105cm and offers enough space for biggest fish.

Equipped with aluminum spreader block.

BLACK WIDOW CARP LANDING NET

WITH ONE-PIECE HANDLE

Art.-No.	Length cm	Closed L. cm	Size cm	Net Depth cm	Mesh mm	Sect.
11579-180	182	182	100x100	105	8	1

BLACK WIDOW CARP LANDING NET

WITH TELESCOPIC HANDLE

Art.-No.	Length cm	Closed L. cm	Size cm	Net Depth cm	Mesh mm	Sect.
11579-185	181	105	100x100	105	8	2



BLACK WIDOW 3 ROD BAG

CARP ROD HOLDALL | FOR 3 RODS

These premium, padded and very robust holdalls can store up to three rigged rods. Also fitting for size 50 starter guides. With padded dividers and hook and loop fastener strap for optimal protection of the rods. With superimposed pocket for tackle like banksticks, weight sling etc. The PVC bottom prevents the intrusion of moisture. Equipped with padded shoulder strap and carrying handles.

Material: Bag polyester



Art.-No.	Size cm	Version
18705-310	170x35x15	for 3 10ft rods
18705-312	202x35x15	for 3 12ft rods
18705-313	215x35x15	for 3 13ft rods

BLACK WIDOW ROD SLEEVE

ROD HOLDALL | FOR 1 ROD

Padded, premium single holdall for one rigged rod. Stores also rods with size 50 starter guides.

Material: Bag polyester



Art.-No.	Size cm	Version
18705-110	173x28x1	for 1 10ft rod
18705-112	202x28x1	for 1 12ft rod
18705-113	215x28x1	for 1 13ft rod



BLACK WIDOW COOL BAIT BAG

WITH THERMO INSULATION | L-SIZE

This lightweight cooler is ideally suited for short trips. The main compartment is completely isolated and keeps bait and food at the right temperature. The big front pocket offers space for documents etc. Equipped with shoulder strap and carrying handle.

Material: Bag polyester

Art.-No.	Size	Size cm
18705-300	L	36x29x24

BLACK WIDOW

BLACK WIDOW LOW LEVEL CARRYALL

CARP BAG

This big multi-purpose carryall offers plenty of storage space for accessories, clothing etc. With two big superimposed pockets at both sides and an extra big front pocket for banksticks, bite indicator, etc. The PVC bottom prevents the intrusion of moisture via the ground. The bag is designed to be easily stored under a carp bedchair. Equipped with padded shoulder strap and carrying handles.

Material: Bag polyester

Art.-No.	Size cm
18705-045	62x40x24



BLACK WIDOW COMPACT TACKLE BAG

This compact tackle bag is perfectly made for short fishing trips, when not that much tackle is needed. The big front pocket offers space for a big tackle box. The PVC bottom prevents the intrusion of moisture via the ground. Both side pockets are suited ideally for bite indicator and additional accessories.

Material: Bag polyester

Art.-No.	Size cm
18705-055	52x30x24



BLACK WIDOW COMPACT RUCKSACK

Lightweight, robust and spacious rucksack. With two big superimposed pockets on both sides and two big front pockets for tackle boxes, banksticks, etc. The interior can be cleaned easily when necessary. Equipped with padded shoulder strap and carrying handles.

Material: Bag polyester

Art.-No.	Size cm
18705-015	52x32x35





DAIWA SLEEP SYSTEM

WITH INTEGRATED SLEEPING BAG

The DAIWA sleep system bedchair gives you a super comfortable sleeping time! The solid high-tech foam mattress, can be kept level (Lay Flat System) and thus offers high comfort even during long fishing trips. On the top of the bed we have put on a fully secured two layer sleeping bag which can be used nearly during the whole fishing season.

Material: Bedchair cover polyester; Sleeping bag polyester

- Light steel frame with 6 legs and mud feet
- Lay flat system
- Sleeping bag is fixed to the mattress via zipper

Art.-No.	Size cm
18860-100	212x88x39



DAIWA FOLDING CHAIR

WITH ARMREST

This super comfortable chair with built in arm rests is constructed from a steel frame with a thick polyester and foam mattress. The chair has two mud feet at the front that are individually adjustable and stand firmly even on rough ground. Ideal chair to relax in. Can be fold away easily and space-saving.

Material: Cover polyester



Art.-No.	Size cm
18702-150	55x32x87

DAIWA BOAT POD 3 POD

FOR 3 RODS

Premium, portable boat rod pod made of aluminum and steel. Up to three rods can be fished with this pod. The angle can be easily adjusted via knob. The pod can easily be attached to the transom of the boat or at the jetty. The screw clamp fits up to a diameter of 50mm.

Material: Rod pod aluminum; Transportation bag polyester

Art.-No.	Size cm	Weight kg	Capacity
18800-901	80x20x10	2.88	for up to 3 rods



BLACK WIDOW LOW LEVEL 3 ROD POD

4-LEGGED | FOR 3 RODS

The lightweight classic Black Widow Low Level pod is very convenient to set up and remains very stable at the ground. With 4 adjustable banksticks and buzzerbars with brass thread for 3 bite indicators.

Delivered with transportation bag.

Material: Rod pod aluminum; Transportation bag polyester

BLACK WIDOW

Art.-No.	Size cm	Version
18705-200	88x31x27	for up to 3 rods





FEEL A



DAIWA CLOTHING
2025

LIVE.





TEAM DAIWA FLOTATION SUIT

In cooperation with the leading producer for floating suits and safety clothing in England we developed a floating suit that fully satisfies the demand for high quality and safety aspects for fishing in Norway and Iceland as well as the hard conditions in the winter.

The Team DAIWA floating suit captivates by its wearing comfort. The outer material made of 210D nylon is very supple and strainable and gives good mobility. Of course the floating suit is totally wind- and water-proof. (WP 10.000 rating!) By the special inner Taslon lining, the suits offer even for great cold pleasant and warm wearing comfort. All pockets are created to avoid water running into it when it is raining or there is froth.

Of course the Team DAIWA floating suit is in accordance with all European rules for conception of floating suits.

Material: Outer material nylon; Isolation polyester; Transportation bag polyester

- Extra lightweight and supple material
- Robust and easy to clean
- Polar fleece collar for optimal warmth comfort
- Braced, lined storm-hood with elastic band
- Neoprene cuffs at the sleeves
- Strengthenings at the elbows and knees
- Reflecting foil at the shoulders, sleeves and trousers
- Diverse attached pockets give room for small parts, pliers etc.
- Lined fleece pocket to warm the hands
- Premium YKK-zippers
- Velcro at the end of the legs
- EN 393 certified

Delivery includes:

- Emergency whistle
- Team DAIWA transportation bag

Art.-No.	Size
18510-110	S
18510-120	M
18510-130	L
18510-140	XL
18510-150	2XL
18510-160	3XL

DAIWA D-VEC WINTER BOOTS X'TREME

WITH INLAY SHOES

This extremely lightweight EVA boot is perfectly suited for the very cold season. The thickly padded inlay can be removed for cleaning. The threaded rubber sole ensures good grip even on slippery and stony ground. The wide shaft offers enough space even for strong calves.

Suited for temperatures down to -20 degrees.

Material: Boots EVA; Inner shoe polyester; Sole rubber



Art.-No.	Size
18516-040	39/40
18516-042	41/42
18516-044	43/44
18516-046	45/46

DAIWA D-VEC WINTER SUIT

NEW

WINTER SUIT

Thick padded 2pcs. suite to cope especially during cold conditions in spring, autumn and winter period. The special cutting style on arms and elbows provides comfortable usage and mobility during casting and retrieving. The long backside cut keeps convenient temperatures at kidney areas and prevents inflowing cold winds. The material features a water resistance level of 6.000mm and an easy to clean surface. The jackets main zipper features a water resistance construction – same as both the two spacious side pockets and the small chest pocket. The large, padded spray hood keeps rain and wind out and offers good sight and mobility during fishing. Knitted cuffs keep water and cold out from intruding through the arms. The extra high loft Bib´n Brace with large side pockets keeps your body warm and features easy adjustable shoulder straps.

- **Padding: Polyester, 200g/m²**
- **Breathability: 5.000**
- **Water resistance: 6.000mm**

Material: Outer material nylon; Inner lining polyester

Art.-No.	Size
18868-010	M
18868-020	L
18868-030	XL
18868-040	2XL



DAIWA WINTER CARP SUIT

OLIVE GREEN

We refined our well-established and field-tested two-piece winter suit with new features and a modern cut – ideal for sessions during the cold season. The premium, breathable jacket offers two side pockets and one big breast pocket with water-repellent zipper. The cuffs at the sleeves reliably prevent intrusion of rain and frostiness during the fight. The high-waist overalls provide hook and loop fastener at the feet and two deep side pockets with magnetic fastener for quick access. The elastic braces offer optimal wearing comfort even over longer walking distances. The surface is very silent and easy to clean.

Material: Outer material nylon; Inner lining polyester



- **Premium inner lining (200g/m²)**
- **Taped seams**
- **Water column 5000mm/3000mm**
- **Breathable**

Art.-No.	Color	Size
18865-310	olive green	S
18865-320	olive green	M
18865-330	olive green	L
18865-340	olive green	XL
18865-350	olive green	2XL
18865-360	olive green	3XL



DAIWA D-VEC WADERS

NEW

GREY

This DAIWA D-VEC neoprene wader is made out of 4mm neoprene material and features quality rubber boots with cleated sole and steel shank construction. For optimum comfort, the boots are fully lined with neoprene material. The neoprene material features high flexibility and wearing comfort. All seams are taped to guarantee highest watertightness.

The knee area was strengthened by neopren knee pads to further support those areas. The chest pocket features easy access from both sides. The XL sizes are special belly sizes.

Material: 90% neoprene, 10% nylon

Art.-No.	Color	Size
18520-839	grey	38/39
18520-041	grey	40/41
18520-243	grey	42/43
18520-243XL	grey	42/43
18520-445	grey	44/45
18520-445XL	grey	44/45
18520-647	grey	46/47
18520-647XL	grey	46/47

DAIWA D-VEC WADERS FLEX

NEW

BLACK

High quality, lightweight waders made by 4mm CR neoprene and outstanding design. The unique features of CR neoprene benefit in more flexibility and softness compared to ordinary neoprene material. The wear comfort is improved and lightness can be achieved.

The large chest pocket features water repellent zippers and save and dry storage for small accessories.

The high loft backside supports the fitting and enables long lasting constant fishing. The knee area was strengthened by special knee pads to further support those areas. An adjustable belly strap supports the fitting and reduces the risk of unexpected fast intruding water.

All inner seams are taped for maximum security. With high quality rubber boots with cleated sole.

Material: 90% neoprene, 10% nylon

Art.-No.	Color	Size
18521-839	black	38/39
18521-041	black	40/41
18521-243	black	42/43
18521-243XL	black	42/43
18521-445	black	44/45
18521-445XL	black	44/45
18521-647	black	46/47
18521-647	black	46/47



DAIWA D-VEC WADERS FLEX WITH SOCKS

NEW

BLACK

High quality, lightweight waders made by 4mm CR neoprene and outstanding design. The unique features of CR neoprene benefit in more flexibility and softness compared to ordinary neoprene material. The wear comfort is improved, and outstanding lightness is achieved.

The neoprene sock's cutting design provides long lasting comfort even on long walking distances on rough grounds.

The large chest pocket features water repellent zippers and save and dry storage for small accessories.

The high loft backside supports the fitting and enables long lasting constant fishing.

The knee area was strengthened by special knee pads to further support those areas. An adjustable belly strap supports the fitting and reduces the risk of unexpected fast intruding water.

All inner seams are taped for maximum security.

Material: 90% neoprene, 10% nylon

Art.-No.	Color	Size
18522-839	black	38/39
18522-041	black	41/42
18522-243	black	42/43
18522-243XL	black	42/43
18522-445	black	44/45
18522-445XL	black	44/45
18522-647	black	46/47



DAIWA D-VEC WADING JACKET

NEW

GREY CAMO

Exclusive grey camouflage high quality breathable wading jacket for baltic seatrout fishing and freshwater lure fishing.

The modern material provides lightness and outstanding wearing comfort.

This DAIWA wading jackets features an outstanding price-quality ratio and high protection from intruding water and cold winds thanks to its waterproof level of 10.000mm.

The arm and elbow area has been special designed to allow maximum mobility during fishing and offers perfect comfort during usage. The tight neoprene cuffs keep water and winds out from intruding through the arms. All zippers feature a water repellent function and save storage of bit's n pieces in the pockets.

- **Water resistance: 10.000mm**
- **Breathability: 10.000**

Material: polyester

Art.-No.	Color	Size
18869-010	grey camo	M
18869-020	grey camo	L
18869-030	grey camo	XL
18869-040	grey camo	2XL

DAIWA CARP CAMO T-SHIRT

GREEN CAMO



T-shirt exclusively designed for our Carp range.

Material: cotton

- **Weight 180g/m²**
- **With anti-pilling function**



Art.-No.	Color	Size
18865-020	green camo	M
18865-030	green camo	L
18865-040	green camo	XL
18865-050	green camo	2XL
18865-060	green camo	3XL

DAIWA CARP CAMO HOODIE

GREEN CAMO



Classical hoodie with exclusive Camo design.

Material: 80% cotton, 20% polyester

- **Weight 280g/m²**
- **With anti-pilling function**



Art.-No.	Color	Size
18865-120	green camo	M
18865-130	green camo	L
18865-140	green camo	XL
18865-150	green camo	2XL
18865-160	green camo	3XL

DAIWA CARP CAMO JOGGER

LONG | GREEN CAMO

Soft, thick joggers with camo design and zipper pockets.

Material: 80% cotton, 20% polyester



- Weight 280g/m²

Art.-No.	Color	Size
18865-520	green camo	M
18865-530	green camo	L
18865-540	green camo	XL
18865-550	green camo	2XL

DAIWA CARP CAMO JOGGER

SHORT | GREEN CAMO

Soft, thick sweat shorts with camo design and zipper pockets.

Material: 80% cotton, 20% polyester



- Weight 280g/m²

Art.-No.	Color	Size
18865-620	green camo	M
18865-630	green camo	L
18865-640	green camo	XL
18865-650	green camo	2XL

DAIWA D-VEC CARP CAMO CAP

GREEN CAMO

Material: cotton



Art.-No.	Color	Size
18865-605	green camo	unisex

DAIWA D-VEC HOODIE

Premium thick and soft hoodie with special chin-cup – perfect for boat driving.

DAIWA D-VEC HOODIE FEEL ALIVE

GREY

Material: 80% cotton, 20% polyester



Art.-No.	Color	Size
18207-110	grey	M
18207-120	grey	L
18207-130	grey	XL
18207-140	grey	2XL

DAIWA D-VEC HOODIE HALIBUT EXPEDITION

GREY

Limited edition for Norway!

Material: 80% cotton, 20% polyester



Art.-No.	Color	Size
18207-210	petrol green	M
18207-220	petrol green	L
18207-230	petrol green	XL
18207-240	petrol green	2XL

DAIWA D-VEC HOODIE PERCH

PETROL-GREEN

Material: 80% cotton, 20% polyester



Art.-No.	Color	Size
18207-310	grey	M
18207-320	grey	L
18207-330	grey	XL
18207-340	grey	2XL



DAIWA D-VEC POLO SHIRT

BLACK / WHITE

Material: polyester

Art.-No.	Color	Size
18292-120	black/white	M
18292-130	black/white	L
18292-140	black/white	XL
18292-150	black/white	2XL

DAIWA D-VEC BOOTS

NEW

OUTDOOR BOOTS

Very lightweight and solid walking boots with cleated sole. The heel and toe areas are reinforced to improve foothold and wearing comfort. Thanks to the inner construction and adding up an inner membrane as full lining, these boots are fully waterproof and breathable up to the upper cording. Perfectly suitable once you need to step into water from time to time during your fishing. The high cut bootleg provides good ankle support for walking in rough terrains. The cleated high grip sole supports firm grip on muddy or slippery grounds. The upper material features a fast dry function.

Material: synthetics

Art.-No.	Color	Size
18518-040	grey/black	40
18518-041	grey/black	41
18518-042	grey/black	42
18518-043	grey/black	43
18518-044	grey/black	44
18518-045	grey/black	45
18518-046	grey/black	46





DAIWA D-VEC NECKGAITER UV PROTECTION TUBE

Classical multifunctional loop / tube scarf for sun protection.
Sun protection factor (SPF) 25

Available in 4 different camo designs.

Material: polyester



GREY CAMO

Art.-No.	Color	Size	Weight g
18206-101	grey camo	unisex	75

18206-101

18206-102

18206-103

18206-104

GREEN CAMO

Art.-No.	Color	Size	Weight g
18206-102	green camo	unisex	75

ASPHALT

Art.-No.	Color	Size	Weight g
18206-104	asphalt	unisex	75

AQUAMARINE

Art.-No.	Color	Size	Weight g
18206-103	aquamarine	unisex	75

DAIWA D-VEC BEANIE

Thickly woven, very premium beanie with enwrought ceramic powder to optimize and maintain the warming effect at the head. Made in Japan!



DAIWA D-VEC BEANIE

KNIT HAT | BLACK

Material:
80% Acryl, 15% polyamide, 5% cotton

Art.-No.	Color	Size
15800-511	black	unisex

DAIWA D-VEC BEANIE

KNIT HAT | NAVY

Material:
80% Acryl, 15% polyamide, 5% cotton

Art.-No.	Color	Size
15800-512	navy	unisex

DAIWA D-VEC BEANIE

NEW

KNIT HAT | BROWN

Material:
80% Acryl, 15% polyamide, 5% cotton

Art.-No.	Color	Size
15800-514	brown	unisex



DAIWA D-VEC CAP

NEW

CAP | LAZER BLACK

Material: polyester

Art-No.	Color	Size
18206-400	lazer black	unsize



DAIWA D-VEC CAP

NEW

CAP | NAVY

Material: 70% polyester, 30% cotton

Art-No.	Color	Size
18206-401	navy	unsize



DAIWA D-VEC CAP

NEW

CAP | WHITE/BLACK

Material: polyester, recycled

Art-No.	Color	Size
18206-403	white/black	unsize



DAIWA D-VEC CAP

CAP | SPORT GREY / SUEDE

Material: 50% cotton, 50% polyacryl

Art-No.	Color	Size
18205-100	sport grey/suede	unsize



DAIWA D-VEC CAP

CAP | WILD-CAMO / GREY

Material: 50% cotton, 50% polyacryl

Art-No.	Color	Size
18205-101	wild-camo/grey	unsize



DAIWA D-VEC CAP

ANTHRACITE

Material: 80% polyacryl, 20% cotton

Art-No.	Color	Size
18205-501	anthracite	unsize



DAIWA D-VEC CAP

LIGHT GREY / BLACK

Material: cotton

Art-No.	Color	Size
18205-001	light grey/black	unsize





Ultimate Bass Fishing Gears



STEEZ BASS FISHING PROGRAM 2025



Ultimate Bass Fishing Gears

STEEZ BASS FISHING GEAR

The Steez rods and reels have already been developed in 2009 as premium subbrand for bass and finesse fishing and belong to the utmost premium sport fishing products commercially available globally. These products are not only perfectly suited for targeting black bass but are also a superb choice for our domestic target fish like zander, perch & Co.

Our range now is enlarged by a finely selected Steez lure lineup and by the premium Steez single hooks for application with different bass rigs.

Every single original Steez lure is made with the best components available and is designed for a very particular field of application.

Steez – Style with ease.





Ultimate Bass Fishing Gears



STEEZ SYSTEM CRANK

With the Steez cranks you can literally scan the water layers – depending on the model this crank dives from 1.2m (model 100) up to above 5m (model 500). Thanks to their compact, special shape the tried and trusted Steez cranks are easy to cast and present and come into action even at steady retrieving. The slightly curved diving lip offers less water resistance at retrieving, decreases the threat of getting stuck on the bottom and provokes very strong vibrations.

STEEZ CRANK | 100F-SR 54MM

MINI CRANKBAIT | FLOATING | SHALLOW RUNNER

STEEZ CRANK



monster gill



white chart



monster chart



artistic chart



clear monster chart



ghost gill

- **Category:** mini crankbait
- **Lure body:** one-sectioned
- **Type:** Front Weight Oscillation System
- **Hooks:** 2 SaqSas treble hooks
- **Type:** floating
- **Diving type:** shallow runner
- **Diving depth:** up to ca. 1.2m
- **Presentation techniques:** steady retrieve, stop & go
- **Target fishes:** perch, trout, chub, zander

Equipment:

- Lead-free design

Art.-No.	Color	Length cm	Treble Size	Weight g	Content pc.
17510-100	monster gill	5.4	6	10.1	1
17510-101	monster chart	5.4	6	10.1	1
17510-102	clear monster chart	5.4	6	10.1	1
17510-103	white chart	5.4	6	10.1	1
17510-104	artistic chart	5.4	6	10.1	1
17510-105	ghost gill	5.4	6	10.1	1

STEEZ CRANK | 200F-MR 54MM

STEEZ CRANK | 300F-DR 61MM

MINI CRANKBAIT | FLOATING | MEDIUM DEEP RUNNER

CRANKBAIT | FLOATING | DEEP RUNNER

- **Category:** mini crankbait
- **Lure body:** one-sectioned
- **Type:** Front Weight Oscillation System
- **Hooks:** 2 SaqSas treble hooks
- **Type:** floating
- **Diving type:** medium deep runner
- **Diving depth:** up to ca. 2.2m
- **Presentation techniques:** steady retrieve, stop & go
- **Target fishes:** perch, trout, chub, zander

- **Category:** crankbait
- **Lure body:** one-sectioned
- **Type:** Front Weight Oscillation System
- **Hooks:** 2 SaqSas treble hooks
- **Type:** floating
- **Diving type:** deep runner
- **Diving depth:** up to ca. 3.2m
- **Presentation techniques:** steady retrieve, stop & go
- **Target fishes:** perch, trout, zander

- **Equipment:**
- Lead-free design

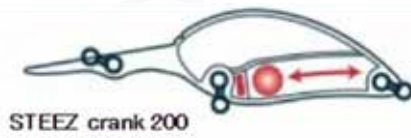
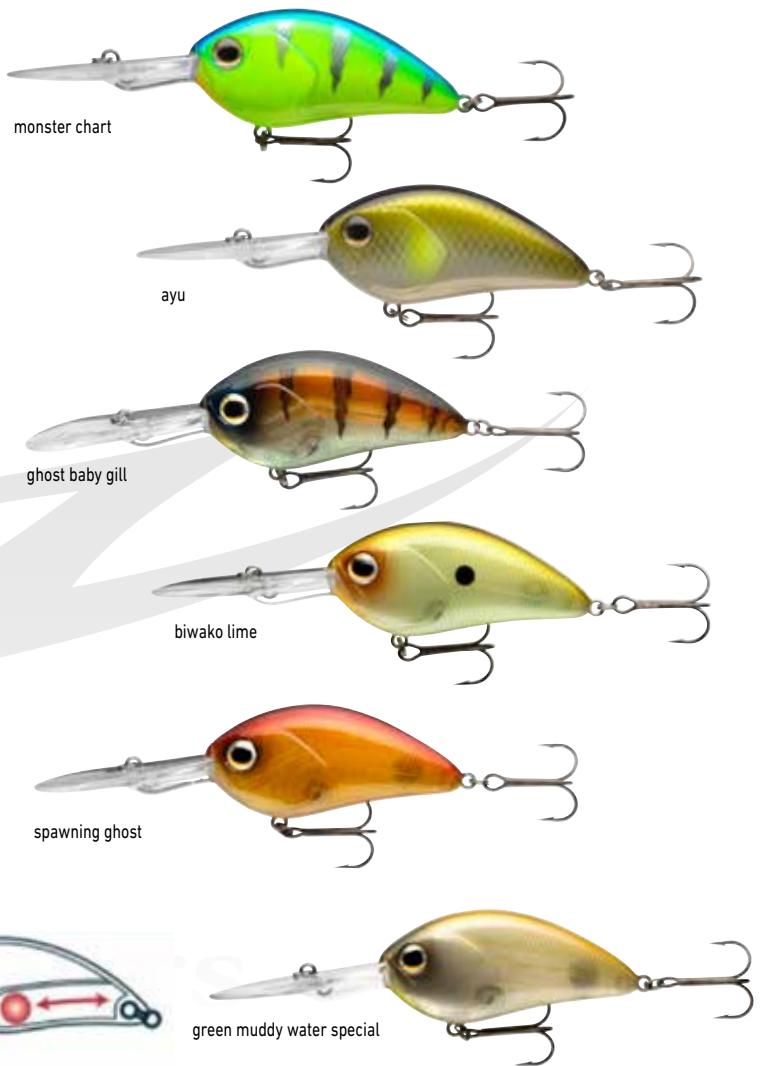
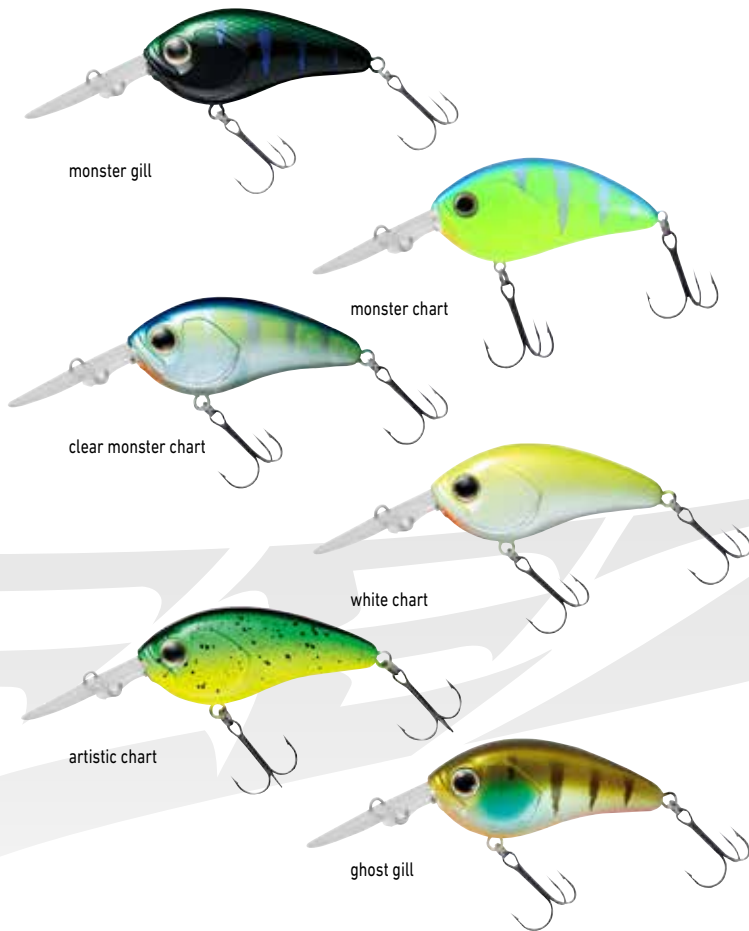

Art.-No.	Color	Length cm	Treble Size	Weight g	Content pc.
17510-200	monster gill	5.4	6	10.6	1
17510-201	monster chart	5.4	6	10.6	1
17510-202	clear monster chart	5.4	6	10.6	1
17510-203	white chart	5.4	6	10.6	1
17510-205	ghost gill	5.4	6	10.6	1
17510-204	artistic chart	5.4	6	10.6	1

Art.-No.	Color	Length cm	Treble Size	Weight g	Content pc.
17510-301	monster chart	6.1	4	18.0	1
17510-302	ayu	6.1	4	18.0	1
17510-303	ghost baby gill	6.1	4	18.0	1
17510-304	biwako lime	6.1	4	18.0	1
17510-305	spawning ghost	6.1	4	18.0	1
17510-306	green muddy water special	6.1	4	18.0	1



STEEZ CRANK | 400F-DR 70MM

CRANKBAIT | FLOATING | DEEP RUNNER

- Category: crankbait
- Lure body: one-sectioned
- Type: Front Weight Oscillation System
- Hooks: 2 SaqSas treble hooks
- Type: floating
- Diving type: deep runner
- Diving depth: up to ca. 4.2m
- Presentation techniques: steady retrieve, stop & go
- Target fishes: perch, zander, pike

STEEZ CRANK | 500F-DR 70MM

CRANKBAIT | FLOATING | DEEP RUNNER

- Category: crankbait
- Lure body: one-sectioned
- Type: Front Weight Oscillation System
- Hooks: 2 SaqSas treble hooks
- Type: floating
- Diving type: deep runner
- Diving depth: up to ca. 5.2m
- Presentation techniques: steady retrieve, stop & go
- Target fishes: perch, zander, pike

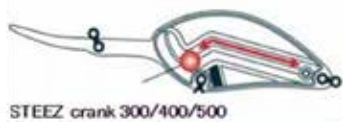
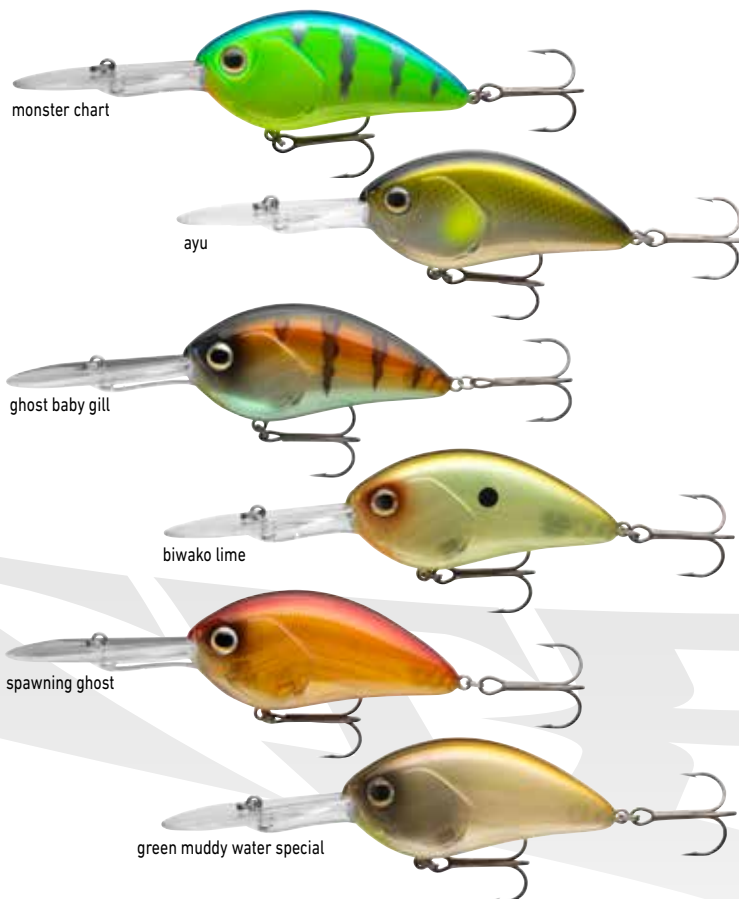
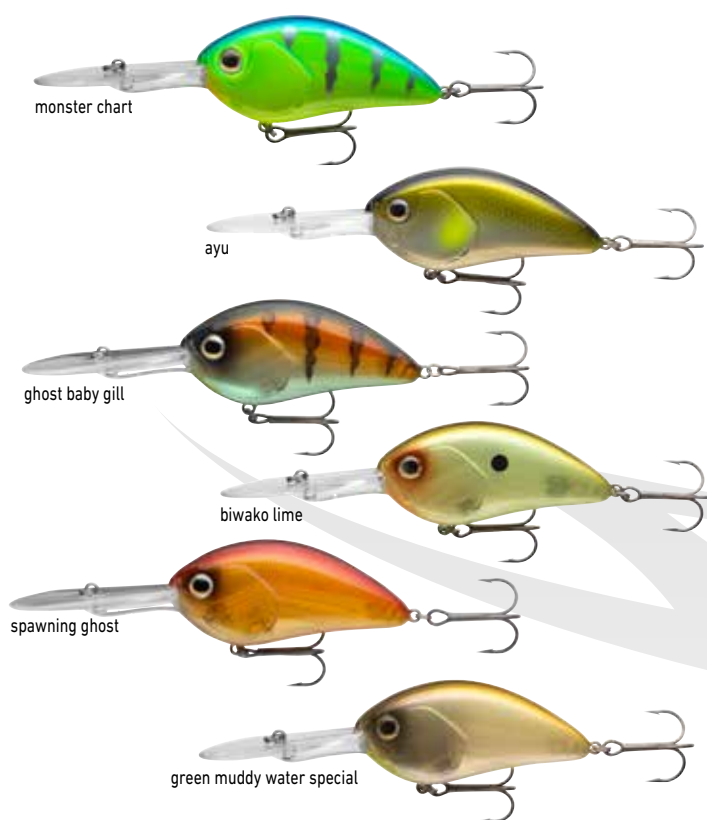

Art.-No.	Color	Length cm	Treble Size	Weight g	Content pc.
17510-401	monster chart	7.0	2	25.6	1
17510-402	ayu	7.0	2	25.6	1
17510-403	ghost baby gill	7.0	2	25.6	1
17510-404	biwako lime	7.0	2	25.6	1
17510-405	spawning ghost	7.0	2	25.6	1
17510-406	green muddy water special	7.0	2	25.6	1

Art.-No.	Color	Length cm	Treble Size	Weight g	Content pc.
17510-501	monster chart	7.0	2	27.8	1
17510-502	ayu	7.0	2	27.8	1
17510-503	ghost baby gill	7.0	2	27.8	1
17510-504	biwako lime	7.0	2	27.8	1
17510-505	spawning ghost	7.0	2	27.8	1
17510-506	green muddy water special	7.0	2	27.8	1

STEEZ CRANK 700

NEW

STEEZ CRANK

CRANKBAIT

This lure is a real gem for deep crank fishing and perfectly suited for bottom bouncing.

This extra large Steez Crank is real depth finder and depth over 7m can be reached whilst casting, that usually are not accessible with casting cranks and other floating plugs. Thanks to the arched diving lip tip, the lure features a super quick reactive action at the beginning of retrieve – just after splash on the water surface. In addition, this unique lip design drains pressure off the rod and supports lighter tackle usage.

The oversized inner tungsten balance weight provides long casting distance – even exposed to heavy head winds.

- **Category:** crankbait
- **Hooks:** 2 SaqSas treble hooks
- **Type:** floating
- **Diving type:** deep runner
- **Diving depth:** ca. 7.2m



ghost ayu



magic shad



citrus shad



black gold

Art.-No.	Color	Length mm	Treble Size	Weight g	Content pc.
17510-701	ghost ayu	90	1/0	55.2	1
17510-702	magic shad	90	1/0	55.2	1
17510-703	citrus shad	90	1/0	55.2	1
17510-704	black gold	90	1/0	55.2	1



STEEZ crank 700



STEEZ SHAD

Classic small shad-style suspending plug. Perfect for targeting perch, zander and even trout! Fast wobbling action – suited for very slow and fast lure presentation – perfect for twitching and jerkbaiting. The Front-Weight-Oscillation system together with the aerodynamic shape enables enormous casting distances.

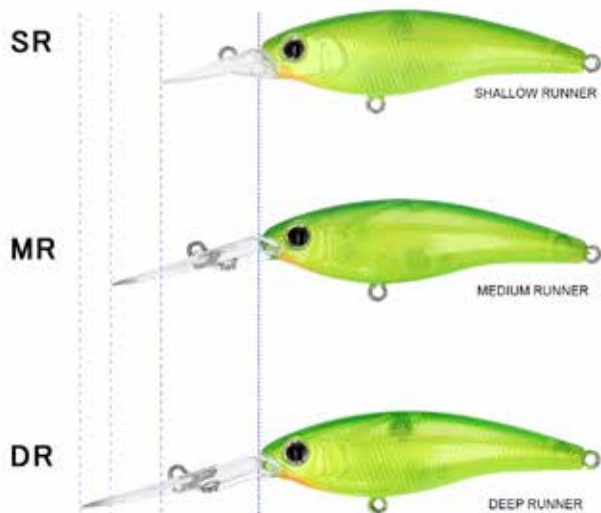

STEEZ SHAD



54		60			潜行深度	
SP (浅層)	F (中層)	SP (浅層)	F (中層)	SP (浅層)		
SR	SR	SR-S	SR	SR	SR-S	1m
MR	MR	MR-S	MR	MR	MR-S	2m
			DR			2.5m

STEEZ SHAD | 60SP-SR

MINNOWBAIT | SUSPENDING | SHALLOW RUNNER

- **Category:** minnowbait
- **Lure body:** one-sectioned
- **Type:** Front Weight Oscillation System
- **Hooks:** 2 SaqSas treble hooks
- **Type:** suspending
- **Diving depth:** up to ca. 1.0m
- **Presentation techniques:** steady retrieve, twitching, stop & go
- **Target fishes:** perch, trout, zander



Equipment:

- Lead-free design



Art.-No.	Color	Length cm	Treble Size	Weight g	Content pc.
17520-000	ghost wakasagi	6.0	7	6.3	1
17520-001	natural pearl ayu	6.0	7	6.3	1
17520-002	wakasagi	6.0	7	6.3	1
17520-003	special shiner	6.0	7	6.3	1
17520-004	matt pink purple	6.0	7	6.3	1
17520-005	akabane lime	6.0	7	6.3	1
17520-006	shirauo	6.0	7	6.3	1
17520-007	SG weed shad	6.0	7	6.3	1

STEEZ SHAD | 60SP-MR

MINNOWBAIT | SUSPENDING | MEDIUM DEEP RUNNER

- **Category:** minnowbait
- **Lure body:** one-sectioned
- **Type:** Front Weight Oscillation System
- **Hooks:** 2 SaqSas treble hooks
- **Type:** suspending
- **Diving depth:** up to ca. 2.0m
- **Presentation techniques:** steady retrieve, twitching, stop & go
- **Target fishes:** perch, trout, zander

Equipment:

- Lead-free design



STEEZ SHAD | 60SP-DR

MINNOWBAIT | SUSPENDING | DEEP RUNNER

- **Category:** minnowbait
- **Lure body:** one-sectioned
- **Type:** Front Weight Oscillation System
- **Hooks:** 2 SaqSas treble hooks
- **Type:** suspending
- **Diving depth:** up to ca. 2.5m
- **Presentation techniques:** steady retrieve, twitching, stop & go
- **Target fishes:** perch, trout, zander

Equipment:

- Lead-free design



Art.-No.	Color	Length cm	Treble Size	Weight g	Content pc.
17520-100	ghost wakasagi	6.0	7	6.7	1
17520-101	natural pearl ayu	6.0	7	6.7	1
17520-102	wakasagi	6.0	7	6.7	1
17520-103	special shiner	6.0	7	6.7	1
17520-104	matt pink purple	6.0	7	6.7	1
17520-105	akabane lime	6.0	7	6.7	1
17520-106	shirauo	6.0	7	6.7	1
17520-107	SG weed shad	6.0	7	6.7	1

Art.-No.	Color	Length cm	Treble Size	Weight g	Content pc.
17520-200	ghost wakasagi	6.0	7	7.0	1
17520-201	natural pearl ayu	6.0	7	7.0	1
17520-202	wakasagi	6.0	7	7.0	1
17520-203	special shiner	6.0	7	7.0	1
17520-204	matt pink purple	6.0	7	7.0	1
17520-205	akabane lime	6.0	7	7.0	1
17520-206	shirauo	6.0	7	7.0	1
17520-207	SG weed shad	6.0	7	7.0	1

Fishing Gears



STEEZ MINNOW

This suspending minnow is excelled by its extreme casting distance – the special balance longcasting system with three tungsten balls inside stretches almost through the entire body and optimizes the casting distances. The rolling flanking action leads to intense vibrations under water.

STEEZ MINNOW

STEEZ MINNOW | 110SP-SR

MINNOWBAIT | SUSPENDING | SHALLOW RUNNER

The SR model dives ca. 1.0-1.3m and thus can be easily presented close to the surface. Perfect for twitching.

- **Category:** minnowbait
- **Lure body:** one-sectioned
- **Hooks:** 3 SaqSas treble hooks
- **Type:** suspending
- **Diving type:** shallow runner
- **Diving depth:** up to ca. 1.3m
- **Presentation techniques:** steady retrieve, twitching, stop & go

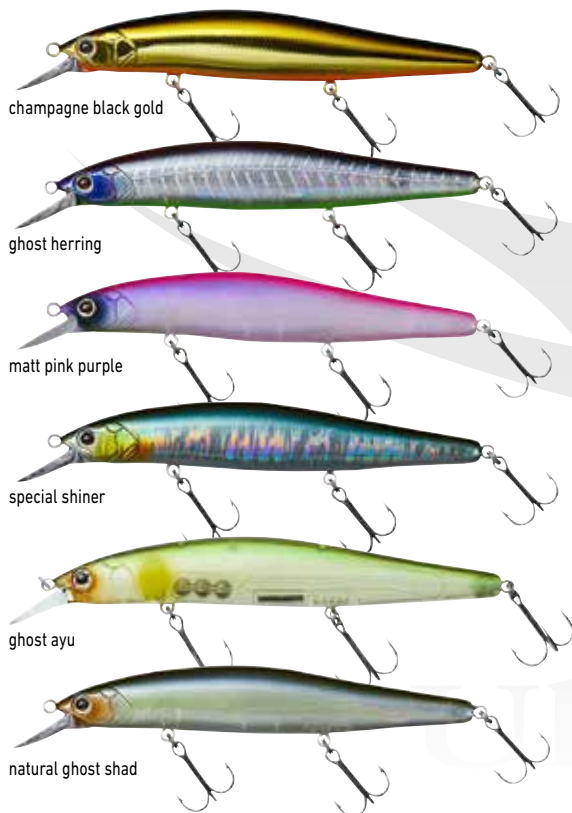

Art.-No.	Color	Length cm	Treble Size	Weight g	Content pc.
17521-000	champagne black gold	11.0	6	14.4	1
17521-001	ghost herring	11.0	6	14.4	1
17521-002	matt pink purple	11.0	6	14.4	1
17521-003	special shiner	11.0	6	14.4	1
17521-004	ghost ayu	11.0	6	14.4	1
17521-005	natural ghost shad	11.0	6	14.4	1



STEEZ MINNOW | 110SP-MR

MINNOWBAIT | SUSPENDING | MEDIUM DEEP RUNNER

The MR model dives ca. 1.5-1.7m and is ideally suited for slow night fishing for zander and targeting perch.

- **Category:** minnowbait
- **Lure body:** one-sectioned
- **Hooks:** 3 SaqSas treble hooks
- **Type:** suspending
- **Diving type:** medium deep runner
- **Diving depth:** up to ca. 1.7m
- **Presentation techniques:** steady retrieve, twitching, stop & go

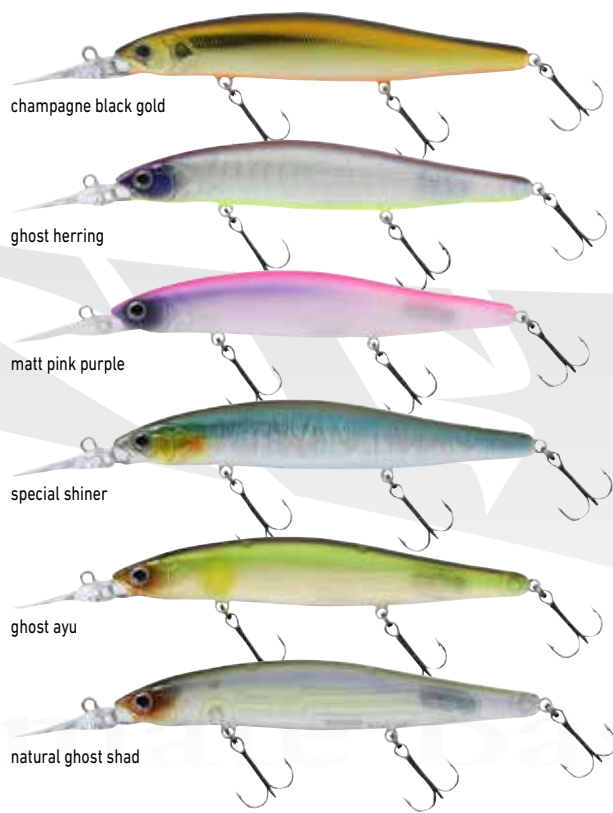

Art.-No.	Color	Length cm	Treble Size	Weight g	Content pc.
17521-100	champagne black gold	11.0	6	15.0	1
17521-101	ghost herring	11.0	6	15.0	1
17521-102	matt pink purple	11.0	6	15.0	1
17521-103	special shiner	11.0	6	15.0	1
17521-104	ghost ayu	11.0	6	15.0	1
17521-105	natural ghost shad	11.0	6	15.0	1

STEEZ PENCIL | 60F

STICKBAIT | FLOATING | TOP WATER

The Steez Pencil is the perfect lure for targeting predators like perch, asp and pike close to the surface during summertime. The compact lure lies tight within the surface, allowing you to maintain straight contact also at high retrieving speed. The special body silhouette allows easy presentation – perfect for walk-the-dog action. The balance weight is fixed at the rear body part and allows optimal casting distances.

- Lure body: one-sectioned
- Hooks: 2 SaqSas treble hooks
- Type: floating
- Diving type: top water
- Presentation technique: Walk-the-Dog
- Target fishes: perch, asp, pike

Equipment:

- Lead-free design

STEEZ PENCIL



wakasagi



black



ghost ayu



shirauo



blue back chart



hasegawa pink ver.3



STEEZ POPPER | 60F

POPPER | FLOATING | TOP WATER

The Steez Popper can easily be brought into action and presented using the walk-the-dog style. Due to the special shape this lure enters the water after the casts with low noise and therefore does not frighten lurking shy fish in the upper water layers. The special plop sound attracts predators also from large distance. Due to its enormous accomplishments the Steez Popper already is a legend in Japan.

- Category: popper
- Lure body: one-sectioned
- Hooks: 2 SaqSas treble hooks
- Type: floating
- Diving type: top water
- Presentation technique: jerkbaiting

Equipment:

- Lead-free design

STEEZ POPPER

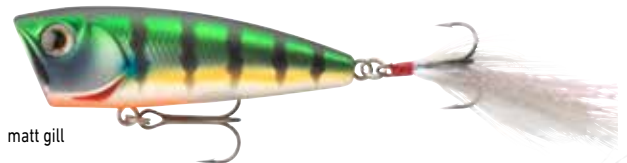

matt gill



blue back chart



bone



SG black gold



Art.-No.	Color	Length cm	Treble Size	Weight g	Content pc.
17512-600	wakasagi	6.0	10	4.2	1
17512-601	black	6.0	10	4.2	1
17512-602	ghost ayu	6.0	10	4.2	1
17512-603	shirauo	6.0	10	4.2	1
17512-604	blue back chart	6.0	10	4.2	1
17512-605	hasegawa pink ver.3	6.0	10	4.2	1

Art.-No.	Color	Length cm	Treble Size	Weight g	Content pc.
17522-000	matt gill	6.0	6	7.6	1
17522-001	blue back chart	6.0	6	7.6	1
17522-002	bone	6.0	6	7.6	1
17522-003	SG black gold	6.0	6	7.6	1



STEEZ PROP

Another Japan legend from the Steez range that has been developed by Koji Hasegawa in Japan. This search bait is perfectly suited for scanning large water areas for actively hunting predators. The extra-lightweight propeller starts already at slow speed – the special SaqSas coating at the socket additionally support easy rotation. The Steez Prop can be retrieved with constant speed and attracts predators from almost all water layers to the lure. Perfect for scanning underwater vegetation, heavy cover etc.

The Steez Prop is available as floating and sinking version.



STEEZ PROP

STEEZ PROP | 85F

PROPBAIT | FLOATING

- **Category:** propbait
- **Lure body:** one-sectioned
- **Hooks:** 2 SaqSas treble hooks
- **Type:** floating
- **Waters:** silent & current waters
- **Presentation technique:** steady retrieve
- **Target fishes:** perch, zander, pike

STEEZ PROP | 85S

PROPBAIT | SLOW SINKING

- **Category:** propbait
- **Lure body:** one-sectioned
- **Hooks:** 2 SaqSas treble hooks
- **Type:** slow sinking
- **Waters:** silent & current waters
- **Presentation technique:** steady retrieve
- **Target fishes:** perch, zander, pike



ghost ayu



clear lime



wakasagi



natural ghost shad

Art.-No.	Color	Length cm	Treble Size	Weight g	Content pc.
17511-000	ghost ayu	8.5	4	12.7	1
17511-001	wakasagi	8.5	4	12.7	1
17511-002	clear lime	8.5	4	12.7	1
17511-003	natural ghost shad	8.5	4	12.7	1

Art.-No.	Color	Length cm	Treble Size	Weight g	Content pc.
17511-100	ghost ayu	8.5	4	13.8	1
17511-101	wakasagi	8.5	4	13.8	1
17511-102	clear lime	8.5	4	13.8	1
17511-103	natural ghost shad	8.5	4	13.8	1

HMKL STEEZ CUSTOM | 137SP

MINNOWBAIT | SUSPENDING

The Steez Custom has been developed in cooperation with the lure building legend and HMKL founder Mr Kazuma Izumi and unites 3 main elements that make this lure a real catching machine. Usually, this lure developer is exclusively manufacturing handmade wooden plugs in limited editions. The goal at this project was to combine the advantages of a handmade wooden plug with the benefits of a plastic lure body, leading to higher production figures and lower costs. The very slim body together with the Silent design and the extreme casting distances unite exactly these aspects and have led to the huge popularity of this lure in Japan. The front and back treble are connected to the lure via a SaqSas swivel within the lure body and due to their free rotation prevent losses during the fight. For ultimate convenience the interior Weight-Oscillation system has also been coated with SaqSas material. The Maglock Version S tungsten weight in the body silently glides on the SaqSas rail and stabilizes the lure absolutely silent also at strong strokes. The special diving lip is very slim, inconspicuous and light, leading to a very special lure action and better casting distances.

A truly exceptional lure!

- **Category:** minnowbait
- **Lure body:** one-sectioned
- **Hooks:** 3 SaqSas treble hooks
- **Type:** suspending
- **Diving depth:** up to ca. 2.0m
- **Presentation techniques:** steady retrieve, twitching, stop & go
- **Target fishes:** perch, trout, asp, zander, pike

Equipment:

- Lead-free design

HMKL MINNOW STEEZ CUSTOM



STEEZ CHIQUITA FROG | 38MM

SOFT LURE | READY TO FISH

Finally – a small frog, that can also be inhaled by our domestic perch. With only 38mm body length this lure also imitates larger insects and can be brought to action while remaining almost at the spot due to the deep front cup and the long skirt. Perfect for very slow walk the dog action. The reduced buoyancy cares for a better hooking rate.

The Chiquita Frog with the color „Spring Wakasagi“ features tinsel skirts – all other models feature silicone skirts.

- **Hook:** SaqSas double hook
- **Diving type:** top water
- **Presentation technique:** jerkbaiting
- **Target fishes:** perch, asp

Equipment:

- Lead-free design



STEEZ CHIQUITA FROG



Art.-No.	Color	Length cm	Treble Size	Weight g	Content pc.
17510-900	super wakasagi	13.7	4	16.1	1
17510-901	natural ghost shad	13.7	4	16.1	1
17510-902	ghost ayu	13.7	4	16.1	1
17510-903	half mirror wakasagi	13.7	4	16.1	1

Art.-No.	Color	Length cm	Weight g	Content pc.
17512-500	green toad	3.8	6.2	1
17512-501	splatter chart	3.8	6.2	1
17512-502	spring wakasagi	3.8	5.3	1
17512-503	50' mercury	3.8	6.2	1



STEEZ STIRRING SHAD

STEEZ STIRRING SHAD

Universally applicable lure that works with many different techniques. Perfect for slow and steady presentation over weedy areas and underwater structures. For increased stability and hooking rate this lure is equipped with a special hook socket at the head for using offset hooks.

Additionally, the Steez Stirring Shad features a special nail sinker socket at the belly to apply nail sinkers without damaging the lure. The oval shape stabilizes the action and leads to a large silhouette from a profile view.

The two smaller versions (5.3cm and 7.1cm) are specially available for fishing for perch. The rubber for these models has been chosen somewhat softer and the bodyshape has been slightly adapted compared to the bigger models, to be able to develop an optimal action even under slow speed.

Due to the wide profile, this shad runs very steady even without weight, wobbles perfectly side to side with its back and is especially suited for fishing over vegetated areas while constant retrieving as well as for drop-shot fishing, free-rig and buzzing style right below the surface. With Nail Sinker Pocket at the head. Phthalat-free!



magic shad



test color



clear chart



crystal hasu



biwako ayu



smoke wakasagi

STEEZ STIRRING SHAD | 53MM

SHAD

- Target fishes: perch, trout, chub

Art.-No.	Color	Length cm	Weight g	Content pc.
17513-100	magic shad	5.3	1.2	10
17513-101	test color	5.3	1.2	10
17513-102	clear chart	5.3	1.2	10
17513-103	crystal hasu	5.3	1.2	10
17513-104	biwako ayu	5.3	1.2	10
17513-106	smoke wakasagi	5.3	1.2	10



53mm

STEEZ STIRRING SHAD | 71MM

SHAD

- Target fishes: perch, trout, chub

Art.-No.	Color	Length cm	Weight g	Content pc.
17513-200	magic shad	7.1	3.0	8
17513-201	test color	7.1	3.0	8
17513-202	clear chart	7.1	3.0	8
17513-203	crystal hasu	7.1	3.0	8
17513-204	biwako ayu	7.1	3.0	8
17513-206	smoke wakasagi	7.1	3.0	8



71mm



STEEZ STIRRING SHAD | 85MM

SHAD

- Target fishes: perch, trout, zander

Art.-No.	Color	Length cm	Weight g	Content pc.
17513-300	magic shad	8.5	8.0	7
17513-301	test color	8.5	8.0	7
17513-302	clear chart	8.5	8.0	7
17513-303	crystal hasu	8.5	8.0	7
17513-304	biwako ayu	8.5	8.0	7
17513-305	aburahaya	8.5	8.0	7



85mm



110mm



130mm



STEEZ STIRRING SHAD | 110MM

SHAD

- Target fishes: perch, zander, pike

Art.-No.	Color	Length cm	Weight g	Content pc.
17513-400	magic shad	11.0	11.5	6
17513-401	test color	11.0	11.5	6
17513-402	clear chart	11.0	11.5	6
17513-403	crystal hasu	11.0	11.5	6
17513-404	biwako ayu	11.0	11.5	6
17513-405	aburahaya	11.0	11.5	6



magic shad



test color



clear chart



crystal hasu



biwako ayu



aburahaya



STEEZ STIRRING SHAD | 130MM

SHAD

- Target fishes: perch, zander, pike

Art.-No.	Color	Length cm	Weight g	Content pc.
17513-500	magic shad	13.0	18.0	5
17513-501	test color	13.0	18.0	5
17513-502	clear chart	13.0	18.0	5
17513-503	crystal hasu	13.0	18.0	5
17513-504	biwako ayu	13.0	18.0	5
17513-505	aburahaya	13.0	18.0	5

STEEZ DOUBLE CLUTCH | 50SP

MINNOWBAIT | SUSPENDING

Within the Japan Steez Programm, the extremely catchy Double Clutch Wobbler now is also available in a smaller, 48mm version, perfectly made for fishing for perch. Due to the special Silent G.O.S system within, great casting distances can be reached despite the light weight. The tungsten balance weight runs via a SaqSas coated axis. A real guarantor for catches, which gains depth quickly (about 1.3m) and can be fished at the spot. Equipped with extremely sharp SaqSas trebles.



IP wakasagi



IP ayu



natural ghost shad



black gold



special shiner



shirauo

- **Category:** minnowbait
- **Lure body:** one-sectioned
- **Type:** Silent Wired Oscillation System (brass)
- **Hooks:** 2 SaqSas treble hooks
- **Type:** suspending
- **Diving depth:** up to ca. 1.3m
- **Presentation techniques:** steady retrieve, twitching, stop & go
- **Target fishes:** perch, trout, zander

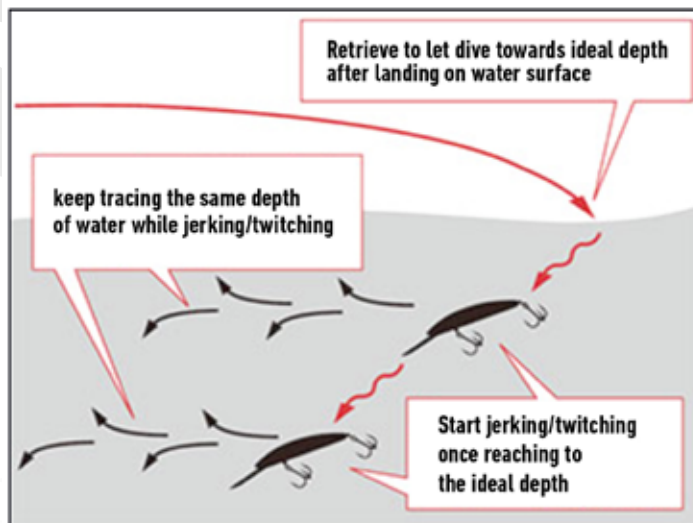

Art.-No.	Color	Length mm	Treble Size	Weight g
17523-000	IP wakasagi	48	2	2.7
17523-001	IP ayu	48	2	2.7
17523-002	natural ghost shad	48	2	2.7
17523-003	black gold	48	2	2.7
17523-004	special shiner	48	2	2.7
17523-005	shirauo	48	2	2.7

STEEZ HOG

Small crab imitation for drop shot, Carolina- and Texas Rig, as well as other finesse techniques. The ribbed, flat body eases the gliding under water, the antennas move also at gentle retrieving and optimize the bite frequency. The 5.6cm model features a higher salt content than the 7.6cm version to allow greater casting distances with this small lure when using weightless offset hooks.



molted shrimp

56mm



STEEZ HOG

STEEZ HOG | 56MM

SOFT LURE

- Type: slow sinking
- Target fishes: perch, trout, chub, zander

Art.-No.	Color	Length cm	Content pc.
17512-000	shrimp	5.6	10
17512-001	lake shrimp	5.6	10
17512-002	red crawfish	5.6	10
17512-003	blue crawfish	5.6	10
17512-004	black shrimp head	5.6	10
17512-005	molted shrimp	5.6	10



shrimp



lake shrimp



red crawfish



blue crawfish



black shrimp head



molted shrimp

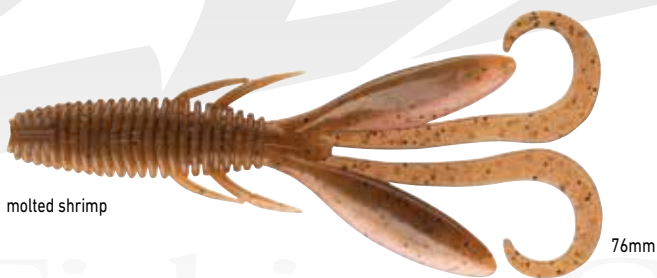

molted shrimp

76mm

STEEZ HOG | 76MM

SOFT LURE

- Type: slow sinking
- Target fishes: perch, trout, asp, zander, pike

Art.-No.	Color	Length cm	Content pc.
17512-100	shrimp	7.6	8
17512-101	lake shrimp	7.6	8
17512-102	red crawfish	7.6	8
17512-103	blue crawfish	7.6	8
17512-104	black shrimp head	7.6	8
17512-105	molted shrimp	7.6	8



STEEZ WORM HOOK

For the Steez Worm Hooks the ultimate SaqSas sharpening technology is used. The usual coarsenesses at the hook surface are almost completely eliminated by a special fluoride coating procedure – the hook tip gets sharper. This leads to a markedly improved intrusion of the hook, better hooking rates are the result. These hooks are made in Japan to 100%.

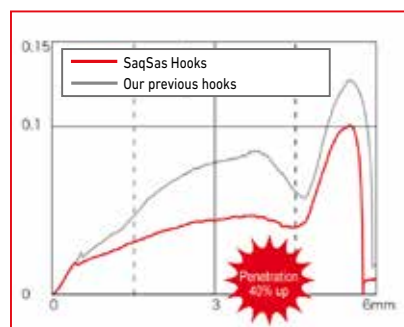

STEEZ WORM HOOK

FINESSE SINGLE HOOK

Developed together with the DAIWA Works team. Extremely sharp and lightweight at the same time – with SaqSas coating. The angle of the hook eyelet has been optimized in numerous testing scenarios to ensure the maximum hooking rate.



Art.-No.	Hook Size	Content pc.
17702-001	1	10
17702-002	2	12

STEEZ WORM HOOK

WACKY SINGLE HOOK

This hook has been developed particularly for Wacky and Neko rigs. The special curve at the hook shank cares for a safe hold of the lure. Can be used with a 90° or 180° angle at the lure.



Art.-No.	Hook Size	Content pc.
17700-001	1	8
17700-100	1/0	7
17700-200	2/0	6

STEEZ WORM HOOK

NEW

FINE FINESSE SINGLE HOOK

Art.-No.	Hook Size	Content pc.
17706-002	2	9
17706-003	3	9



STEEZ WORM HOOK

OFFSET RING SINGLE HOOK

Extremely sharp SaqSas Off Set hook with welded ring. Perfect for Dropshot rigs or the Jika rig – thanks to the ring the hook tip always perfectly points upwards. With using the ring, the line is additionally spared, since no edges are protruding. The ring allows you to exactly tailor the distance from the hook to the ground and enables you to always target the proper height.



Art.-No.	Hook Size	Content pc.
17701-001	1	3
17701-100	1/0	3
17701-200	2/0	3
17701-300	3/0	3

STEEZ WORM HOOK

WIDE OFFSET SINGLE HOOK

Extremely sharp SaqSas Offset hook – made in Japan. The positioning of the hook tip has been moved upwards to ensure a better hooking rate.



Art.-No.	Hook Size	Content pc.
17703-100	1/0	9
17703-200	2/0	8
17703-300	3/0	7
17703-400	4/0	6
17703-500	5/0	5



PRESSO TROUT AREA PROGRAM 2025

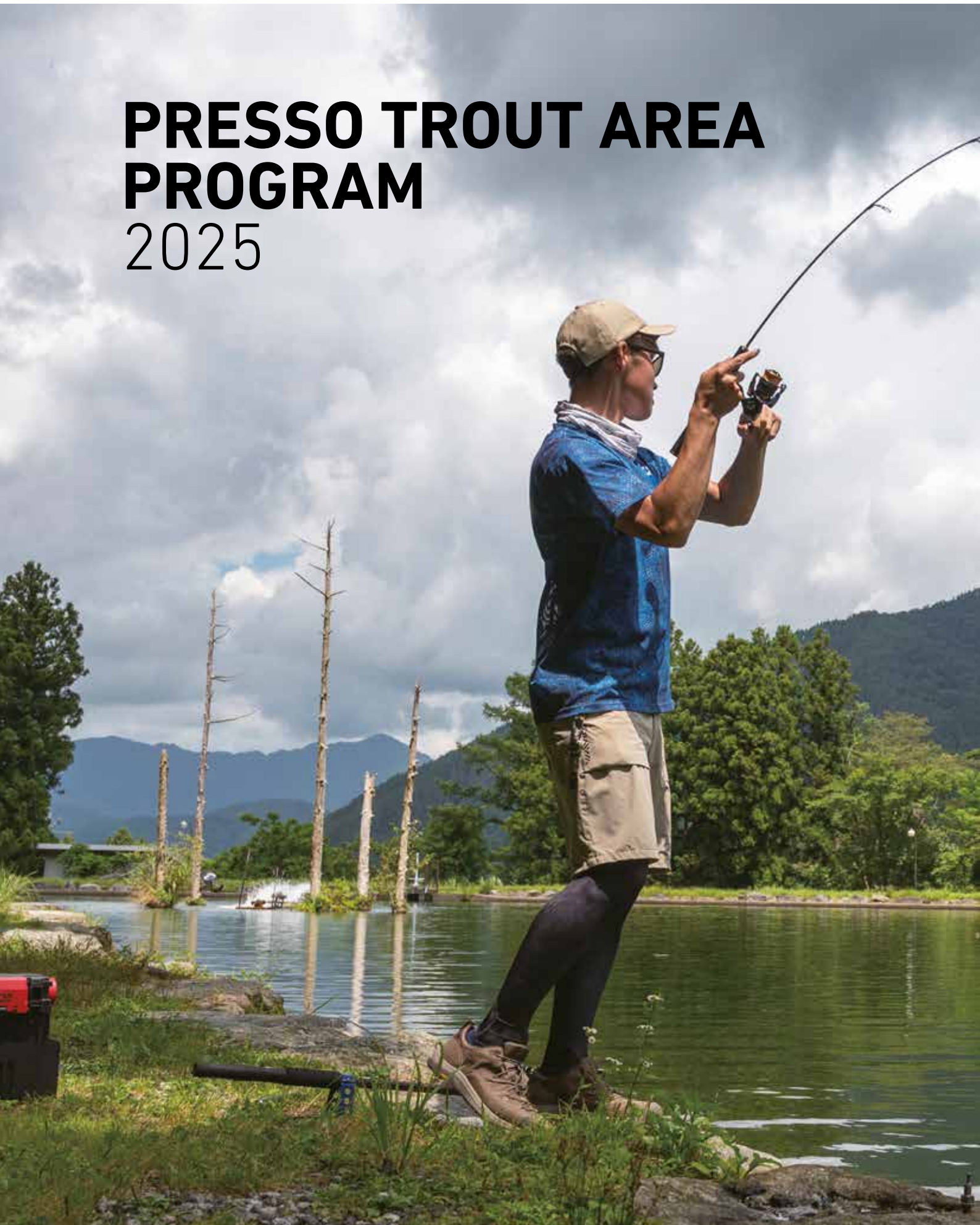





PRESSO

The **DAIWA Presso** range has been developed in Japan especially for the purpose of trout competitions (Trout Area) and has been successfully introduced into several European countries like Italy in recent years. This range comprises Presso Spoons with a broad color range and weights from 1.2 to 7 gram.

Every model is characterized by its own unique action.



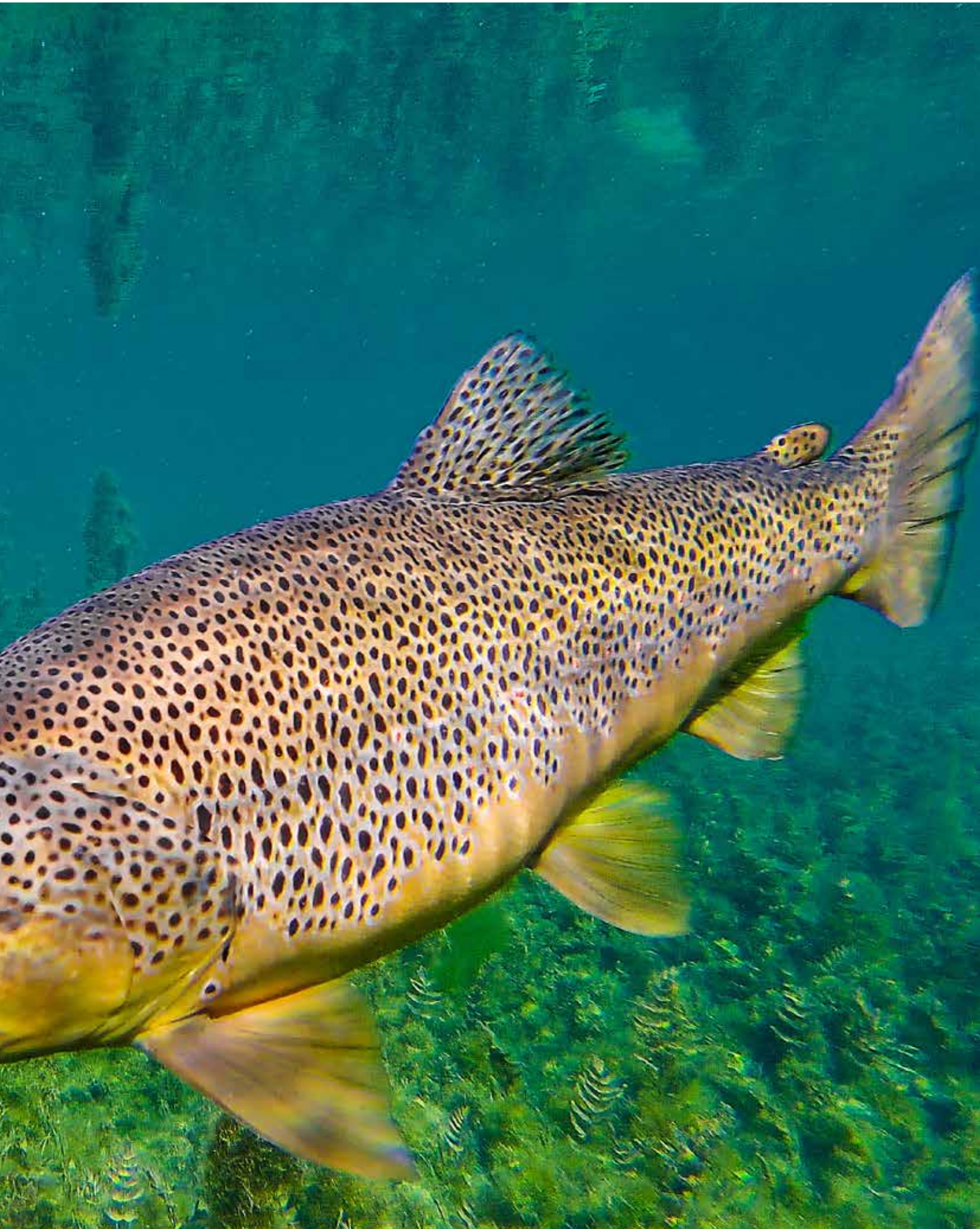



PRESSO

Due to the high demand the original Presso spoons are now also available in the European program.

The range offers the proper model for almost all depths and retrieving speeds. The Presso spoons convince by their premium coating, which does not chip off even after frequent use.

All hooks feature a semi-barb.

PRESSO LMN

SPOON

Strongly flanking „High Pitch“ action within the water. Perfect for nearly all water layers. Ideal for slowly retrieving.

- Waters: silent & current waters
- Target fish: trout



Art.-No.	Color	Length cm	Weight g	Content pc.
15443-111	dark forest	2.4	1.9	1
15443-113	flashing green	2.4	1.9	1
15443-115	green gold yamame	2.4	1.9	1
15443-119	grotta azzurra	2.4	1.9	1
15443-124	light pink	2.4	1.9	1
15443-125	lightning green	2.4	1.9	1
15443-128	mocha magma	2.4	1.9	1
15443-129	neon glow	2.4	1.9	1
15443-132	orange mango	2.4	1.9	1
15443-136	salmon basil	2.4	1.9	1
15443-140	snow peas	2.4	1.9	1
15443-147	yellow dagger	2.4	1.9	1

PRESSO CNK

SPOON

The CNK offers a strongly flanking action. Ideal for deeper water layers or when great casting distances are necessary.

- Hook: single hook, semi barb
- Waters: silent & current waters
- Target fish: trout



Art.-No.	Color	Length cm	Weight g	Content pc.
15441-100	abalone chart yamame OB	3.2	4.0	1
15441-200	abalone chart yamame OB	3.6	7.0	1
15441-101	abalone pink gold	3.2	4.0	1
15441-201	abalone pink gold	3.6	7.0	1
15441-102	abalone pink yamame	3.2	4.0	1
15441-202	abalone pink yamame	3.6	7.0	1
15441-103	akakin yamame	3.2	4.0	1
15441-203	akakin yamame	3.6	7.0	1
15441-107	BP tail	3.2	4.0	1
15441-207	BP tail	3.6	7.0	1
15441-114	gold	3.2	4.0	1
15441-214	gold	3.6	7.0	1
15441-120	holo GP	3.2	4.0	1
15441-220	holo GP	3.6	7.0	1
15441-134	rainbow BK	3.2	4.0	1
15441-234	rainbow BK	3.6	7.0	1
15441-135	red belly	3.2	4.0	1
15441-235	red belly	3.6	7.0	1
15441-137	salmon egg	3.2	4.0	1
15441-237	salmon egg	3.6	7.0	1
15441-139	silver	3.2	4.0	1
15441-239	silver	3.6	7.0	1
15441-146	yamame OB	3.2	4.0	1
15441-246	yamame OB	3.6	7.0	1

PRESSO ADM

SPOON

Available in 2 weights. The allrounder within the Presso program. For all presentation speeds.
The 3.8g model is ideally suitable for deeper areas.

- Hook: single hook, semi barb
- Waters: silent & current waters
- Target fish: trout

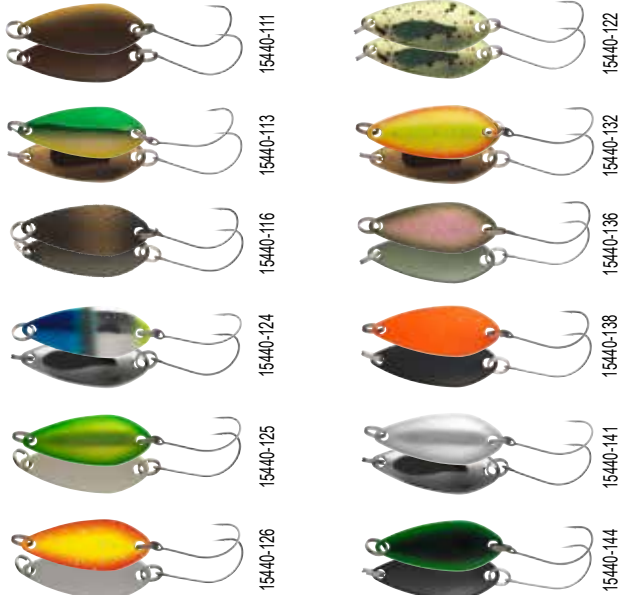

PRESSO MVR

SPOON

The MVR model owns a large silhouette and shows completely different moves concerning the retrieving speeds. Slowly retrieving causes strong lateral flanking of the MVR, whereas fast retrieving effects trembling.

- Hook: single hook, semi barb
- Waters: silent & current waters
- Target fish: trout



Art.-No.	Color	Length cm	Weight g	Content pc.
15440-111	dark forest	2.6	2.2	1
15440-211	dark forest	2.6	3.8	1
15440-113	flashing green	2.6	2.2	1
15440-213	flashing green	2.6	3.8	1
15440-116	green pellet	2.6	2.2	1
15440-216	green pellet	2.6	3.8	1
15440-124	manhattan	2.6	2.2	1
15440-224	manhattan	2.6	3.8	1
15440-122	lemonade	2.6	2.2	1
15440-222	lemonade	2.6	3.8	1
15440-125	lightning green	2.6	2.2	1
15440-225	lightning green	2.6	3.8	1
15440-126	lightning orange	2.6	2.2	1
15440-226	lightning orange	2.6	3.8	1
15440-132	orange mango	2.6	2.2	1
15440-232	orange mango	2.6	3.8	1
15440-136	salmon basil	2.6	2.2	1
15440-236	salmon basil	2.6	3.8	1
15440-138	shibugaki	2.6	2.2	1
15440-238	shibugaki	2.6	3.8	1
15440-141	snow white	2.6	2.2	1
15440-241	snow white	2.6	3.8	1
15440-144	triple green	2.6	2.2	1
15440-244	triple green	2.6	3.8	1

Art.-No.	Color	Length cm	Weight g	Content pc.
15442-104	area brown	2.8	2.4	1
15442-105	bloody	2.8	2.4	1
15442-109	cream glow	2.8	2.4	1
15442-110	darjeeling	2.8	2.4	1
15442-123	UV fluo-lemonade	2.8	2.4	1
15442-129	neon glow	2.8	2.4	1
15442-130	night&day	2.8	2.4	1
15442-131	orange gold W	2.8	2.4	1
15442-132	orange mango	2.8	2.4	1
15442-142	strawberry	2.8	2.4	1
15442-143	summer beach	2.8	2.4	1
15442-145	tropical mango	2.8	2.4	1

PRESSO EV

SPOON

The smallest and most lightweight micro spoon in the Presso range. Perfect, for shallow areas or presentation near the surface. Suited for very slow retrieving. Can also be combined with a sbirolino.

- Waters: silent & current waters
- Target fish: trout



Art.-No.	Color	Length cm	Weight g	Content pc.
15444-104	area brown	2.3	1.2	1
15444-106	blue/silver	2.3	1.2	1
15444-110	darjeeling	2.3	1.2	1
15444-116	green pellet	2.3	1.2	1
15444-117	green/pink	2.3	1.2	1
15444-118	green tea	2.3	1.2	1
15444-119	grotta azzurra	2.3	1.2	1
15444-125	lightning green	2.3	1.2	1
15444-126	lightning orange	2.3	1.2	1
15444-136	salmon basil	2.3	1.2	1
15444-141	snow white	2.3	1.2	1
15444-147	yellow dagger	2.3	1.2	1

PRESSO DEAZA

SPECIAL SPOON

Extremely catchy, very active lure. Due to the 3 different eyelets, you can easily change the action. The lure is designed asymmetrically and thus offers a diverse, wobbling action even under steady retrieving. Ideal for fishing in deeper waters. Let it bounce at the bottom and jig it up again – like this the lure will seduce especially larger specimen.

- Hooks: 2 single hooks, semi barb
- Waters: silent & current waters
- Target fish: trout

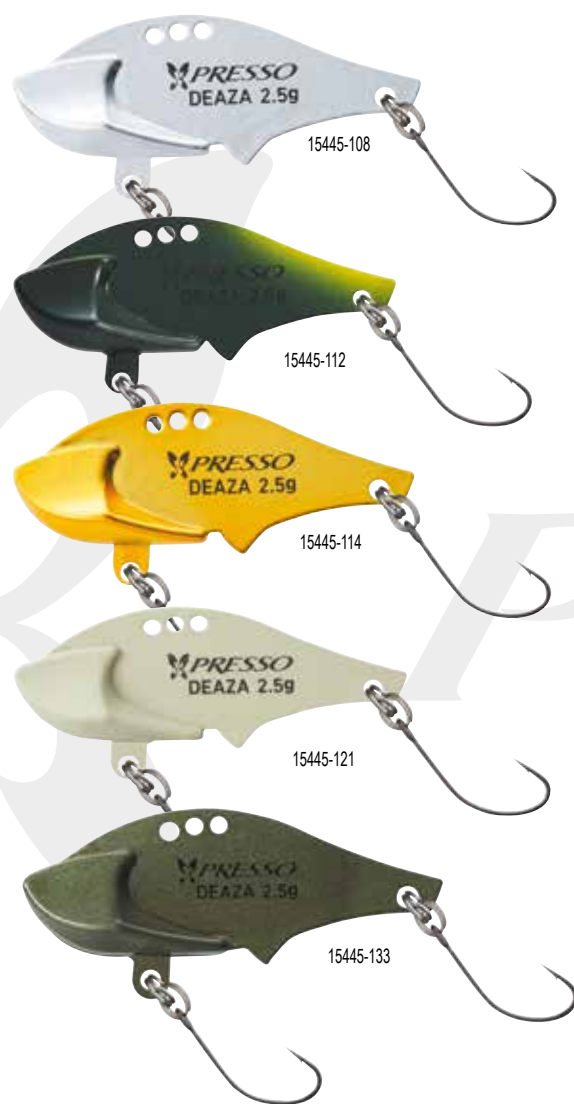

Art.-No.	Color	Length cm	Weight g	Content pc.
15445-108	silver	3.1	2.5	1
15445-112	dark green	3.1	2.5	1
15445-114	gold	3.1	2.5	1
15445-121	latte green glow	3.1	2.5	1
15445-133	pearl olive/pearl ivory	3.1	2.5	1



PRESSO WALLET

LURE / TACKLE BAG

Very premium bags in carbon fiber optic for storing little spoons for trout fishing. The spoons can be fixed horizontally or vertically. The inner separation layer prevents the contact between the hooks and thus damage of the spoons' surfaces. The inner part of the zipper is especially coated to prevent hooking in. Available in two sizes.

- Water-resistant
- 2-way zipper, water-repellent
- Lure and hook protection divider



Art.-No.	Color	Size	Size cm	Weight g
15900-001	black	M	14x20x4	55
15900-002	black	L	17x23x4	63



PRESSO IPRIMI TROUT NET

NEW

TROUT NET

Floating, short handle scoop net with cork handle and aluminium frame. Features a fast dry 6mm rubber mesh to protect fish and to avoid bad odours being absorbed by the material. Perfectly suitable for Trout area fishing once long walking distances are required or for wading in streams and rivers. The elastic band at the rear handle can be easily attached to your belt or tackle bag.



15810-480



15810-480



15810-490



15810-490

Art.-No.	Color Net	Length cm	Handle L. cm	Closed L. cm	Size cm	Net Depth cm	Mesh mm	Sect.	Weight g
15810-480	black orange	59	18	59	40x30	25	6x6	1	250
15810-490	black orange	77	21	77	55x45	35	6x6	1	400

PRESSO IPRIMI ROD STAND

NEW

ROD STAND

Lightweight, quality rod stand made by aluminium for three Trout area rods. Perfectly suitable once various set up's are needed close to hand and to protect those sensible fishing rods from outer impacts during storage on the bank. The telescopic legs are adjustable from 39-62cm length and can be individually adjusted to rough grounds.



15810-001

Features are folding handle for easy transport and optional additional +2 rod mount as separate part to store up to five rods in total.

Art.-No.	Color	Size cm
15905-000	orange	40x12x11
15905-001	grey	25x15x10





PROREX PREDATOR FISHING PROGRAM 2025







RODS





21 PROREX MQ LT

SPINNING REEL

LT LIGHT TOUGH

MQ

TOUGH DIGIGEAR

ZAION V

Spinning reel with power-gear.

The Prorex MQ convinces by its optimal retrieving power and offers a lightweight and distortion-proof housing thanks to the LT design. The extra big MQ gear is positioned securely within the reel body and ensures an enduringly super smooth running even under high strains. The Tough Digigear with extra big gear wheel additionally offers enormous resilience and a long lifespan. The special edge of the ABS aluminum long cast spool takes care for little friction of the line during the cast and thus optimal casting distances. The ATD drag system starts nearly without resistance and ensures optimal security during the fight, especially when used with thin, braided lines.

Due to the MagSealed mechanism, intrusion of water and dirt via the axis is prevented and thus ultra-smooth running and a long lifespan of the gear are further increased.

Depending on the size, the Prorex MQ is perfectly suited for ultra-light spin fishing for perch as well as heavy fishing for pike with big shads up to approx. 23cm.

- **LT (Light & Tough)**
- **ZAION V® MQ® Monocoque reel body**
- **6 ball bearings (incl. 1 CRBB®)**
- **ZAION V® AIR ROTOR®**
- **TOUGH DIGIGEAR®**
- **ATD™ drag system**
- **Cross Wrap® system**
- **Forged ABS® aluminum longcast spool**
- **AIR BAIL®**
- **Twist Buster® II line roller**
- **Machined screw-in aluminum handle**



Equipment:

Size 2000 is delivered with I-Shape handle knob, sizes 2500 to 4000 with T-Shape handle knob.

Arti.-No.	Size	BB CRBB	BB total	Capacity m/mm	Ratio	Retrieval cm	Drag kg	Weight g
10610-200	2000	1	6	150/0.16	5.1:1	67	5.0	175
10610-250	2500D	1	6	150/0.28	5.2:1	73	10.0	195
10610-255	2500-XH	1	6	150/0.20	6.2:1	87	10.0	195
10610-300	3000D-C	1	6	150/0.33	5.2:1	77	10.0	205
10610-305	3000-CXH	1	6	150/0.23	6.2:1	93	10.0	205
10610-400	4000D-C	1	6	150/0.37	5.2:1	82	12.0	230



22 PROREX V LT

SPINNING REEL

LT LIGHT TOUGH

ATD
AUTOMATIC DRAG SYSTEM

TOUGH DIGIGEAR

ZAION V

Highly robust and light.

The Prorex V LT convinces by modern design and innovative DAIWA technology. The LT concept enables the construction of very light and thus resilient reels – especially for spinfishing.

The strong, distortion-proof reel body, made of Zaion V material, ensures a distortion-proof positioning of the Tough Digigear within the reel body and thus a steadily supersmooth running. The Air rotor nearly runs without any starting resistance and guarantees – thanks to the Twist Buster II line roller – an optimal line lay without twist even when used with very thin lines. The medium aluminum spools are perfectly fitting with braided lines. The special edge reduces friction resistance during cast. The ATD drag system ensures high power and starts nearly without resistance – ideal for using very thin braided lines.

Equipment:

Sizes 1000 to 2500 are delivered with I-Shape handle knob, sizes 3000 with T-Shape handle knob and sizes 4000 with EVA handle knob.



- **LT (Light & Tough)**
- **ZAION V® reel body**
- **6 ball bearings (incl. 1 CRBB®)**
- **ZAION V® AIR ROTOR®**
- **TOUGH DIGIGEAR®**
- **Infinite Anti-Reverse®**
- **ATD™ drag system**
- **Cross Wrap® system**
- **Forged ABS® aluminum longcast spool**
- **AIR BAIL®**
- **Twist Buster® II line roller**
- **Machined screw-in aluminum handle**

Art.-No.	Size	BB CRBB	BB total	Capacity m/mm	Ratio	Retrieval cm	Drag kg	Weight g
10609-100	1000	1	6	150/0.14	5.2:1	64	5.0	180
10609-200	2000	1	6	150/0.16	5.2:1	68	5.0	185
10609-250	2500-XH	1	6	150/0.20	6.2:1	87	10.0	205
10609-300	3000-C	1	6	150/0.23	5.3:1	80	10.0	215
10609-400	4000-C	1	6	150/0.28	5.2:1	82	12.0	240
10609-401	4000-CXH	1	6	150/0.28	6.2:1	99	12.0	240



24 PROREX X LT

NEW

SPINNING REEL

LT LIGHT TOUGH **AIRDRIVE DESIGN** **TOUGH DIGIGEAR**

Prorex X LT – Airdrive Design for a top price!

Thanks to the exclusive Airdrive Design made by DAIWA, the Prorex X series is now even lighter and stronger than the previous series. The newly developed Airdrive Rotor helps to reduce total weight and shifts the centre of gravity to the rear unit of the reel – the rotor spins easier and improves sensitivity and lure feeling. The Airdrive Bail was completely redesigned at the bail arm and reduces the risk of line tangles during cast. Perfect for windy conditions and for the usage with thin fishing lines. Thanks to the use of semi-deep spools, the 24 Prorex X LT is specially designed to be used with thin braided lines.

- AIRDRIVE Design
- 5 ball bearings
- AIRDRIVE ROTOR®
- TOUGH DIGIGEAR®
- AIRDRIVE ABS® longcast spool
- AIRDRIVE BAIL
- Twist Buster® III line roller
- Aluminum handle



Equipment:

Size 2000 is delivered with I-Shape handle knob, sizes 2500 to 4000 with T-Shape handle knob.

Art.-No.	Size	BB total	Capacity m/mm	Ratio	Retrieval cm	Drag kg	Weight g
10611-200	2000	5	150/0.16	5.2:1	68	5.0	195
10611-250	2500	5	150/0.20	5.3:1	75	10.0	215
10611-300	3000-C	5	150/0.23	5.3:1	80	10.0	220
10611-301	3000-CXH	5	150/0.23	6.2:1	93	10.0	220
10611-400	4000-C	5	150/0.28	5.2:1	82	12.0	250



PROREX TWS 400 PL-P

NEW

BAITCASTING REEL

TWS
T-Wing System

U.T. Drag
ULTIMATE TOURNAMENT DRAG

Heavy Duty Baitcast!

The 400 size Prorex TWS was specially developed for heavy duty fishing with huge Swimbaits. Body and body cover are fully made of aluminium and prevent gear deflection under heavy loads. The oversized gear teeth provide perfect power transmission and will easily manage any big baits. The heavy duty clutch design secures the clutch to stay in position also at hard casts and reduces risk of losing lures. The handle length can be adjusted from 70mm to 80mm by individual preference. This DAIWA reel is ready to handle whatever you can throw it's way.

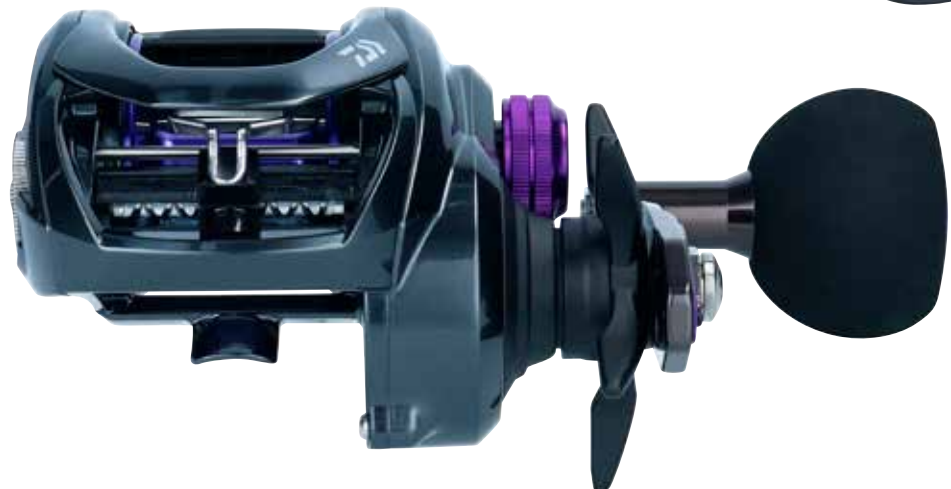

- 7 ball bearings (incl. 2 CRBB®)
- HYPER TOUGH DIGIGEAR®
- Double-Stopper anti-reverse
- UTD® drag system
- Finely adjustable star drag with click-system
- T-Wing System (TWS™)
- Left hand version

Art.-No.	Size	BB CRBB	BB total	Capacity m/mm	Ratio	Retrieval cm	Drag Kg	Weight g
10606-401	400 PL-P	2	7	140/0.48	5.3:1	71	12.0	345



Left hand version



PROREX PE SV TW HSL

BAITCASTING REEL

TWS
T-Wing System

UTD
ULTIMATE TOURNAMENT DRAG

Special model developed for ultra-light fishing for perch & Co. with braided lines.

The super-lightweight and shallow SV spool of the Prorex PE SV TW has been especially designed for the application of thin braids and very small lures. Due to the low starting resistance the Prorex PE SV TW is particularly suited for perch fishing with smallest lures from approx. 4.5g on.

The SV concept reliably prevents backlashes, just stop the spool shortly with the thumb when the lure has reached the water surface at the end of the cast.

The perfect reel for UL fishing for perch or at trout ponds!

- 7 ball bearings (incl. 1 CRBB®)
- UTD® drag system
- Star drag with click-system
- T-Wing System (TWS™)
- SV spool
- Aluminum handle
- Soft-touch handle knob
- Left hand version



Left hand version

Art.-No.	Size	BB CRBB	BB total	Capacity m/mm	Ratio	Retrieval cm	Drag kg	Weight g
10605-105	100HSL	1	7	85/0.23	7.1:1	75	5.0	190



21 PROREX XR TWS PL

BAITCASTING REEL

**HYPERDRIVE
DESIGN**

UTD Drag
ULTIMATE TOURNAMENT DRAG

TWS
T-Wing System

MagForce



Big – Bigger – Big Baits!

The Prorex XR TWS 300PL has especially been developed for heavy fishing for biggest pikes with large swimbaits. The reel exactly offers the fitting line capacity for strong braided lines and – thanks to the 300 reel body – also an optimal balance for heavy baitcasting rods.

The Hyper Drive Design concept contains a combination of many technical details, which make this reel a real powerhouse with enduring lifespan. The Hyper Drive Digigear offers latest technology concerning gear design and durability. Greater teeth within the driving wheel care for an enormous power transmission and a smooth running. Due to the Hyper Double Support, the pinion-gear is housed both-sided within a ball bearing, which enables better power transmission during retrieving under load and a longer lifespan.

The Hyper Tough Clutch prevents unwanted switching of the clutch during the cast and offers perfect security during strong casts. The aluminum Hyper Armed frame cares for an enduring, optimal and distortion-proof housing of the gear within the reel body.

- **HYPER DRIVE Design**
- **Saltwater-resistant construction**
- **8 CRBB® ball bearings**
- **HYPER DRIVE DIGIGEAR®**
- **UTD® drag system**
- **Magforce® magnet drag system**
- **T-Wing System (TWS™)**
- **Aluminum handle**
- **EVA handle knob**
- **Left hand version**



Art.-No.	Size	BB CRBB	BB total	Capacity m/mm	Ratio	Retrieval cm	Drag kg	Weight g
10606-300	300PL	8	8	230/0.33	5.3:1	71	12.0	320





PROREX
RODS





AGS
AIR GUIDE SYSTEM



PROREX AGS SPIN

SVF **AGS**
nanoplus AIR GUIDE SYSTEM

X45 **V-JOINT**

AIR SENSOR

- SVF® Nanoplus carbon fiber blank
- X45® carbon fiber construction
- V-Joint® spigot joint
- DAIWA® Air Sensor reel seat
- AGS® carbon guides
- Fuji® SIC tip guide

The spin and baitcast series from the Prorex predator range for the highest quality demands.

The Prorex AGS rods are featuring almost all highlights of modern and exclusive DAIWA rod building technologies from Japan. These rods particularly impress with their very low weights, perfect balance and a very fast, sensitive and stiff action.

The lineup offers various specialized rods to meet the latest technical demands of modern lure fishing and to provide the perfect tackle for almost every type of lure fishing. The SVF Nanoplus material creates optimum resilience for the blank – by using the Nanoplus technology the resin content in the blank and therefore the total weight could be reduced to a minimum, whereas simultaneously strength and fastness of the blanks have been improved.

The blank immediately transmits every movement of the lure to the palm, and you will be able to realize even very short and tiny bites. The X45 blank construction reduces torque to a minimum and will improve casting distance and accuracy.

The V-joint spigot connection improves the bending curve and thus ensures a very even bending under load. Another outstanding highlight of this rod series are the exclusive DAIWA AGS guides made of carbon. These guides are considerably lighter than conventional rod guides and impressively improve the action and sensitivity of the rods – lure action and fast bites can easily be detected. The AGS rods feature an extremely fast action with outstanding sensitivity.

The Air Sensor reel seat is very comfortable to hold thanks to its ergonomic shape and supports long lasting, fatigue-free fishing.

The Finesse, Chebujig, Jigspin, Sensor Jig models and rods with a casting weight up to 42g are all featuring a carbon rear handle for improved sensitivity.

PROREX AGS SPIN

NEW

SPINNING ROD | M | MH | H

Designed for the special requirements of modern lure fishing with soft and hard lures. The lighter AGS models including 42g casting weight are featuring an exclusive carbon handle that considerably improves feeling and sensitivity! The rods with casting weights over 42g are equipped with EVA handles.

Art.-No.	Length m	CW g	Action	Closed L. cm	Sect.	Guides	Weight g
11213-240	2.40	7-32	extra fast	126	2	9	115
11213-270	2.70	7-32	extra fast	141	2	9	140
11213-241	2.40	14-42	extra fast	126	2	9	125
11213-271	2.70	14-42	extra fast	141	2	9	140
11213-250	2.50	28-70	extra fast / fast	134	2	9	145



11213-250



11213-240

PROREX AGS FINESSE SPIN

NEW

SPINNING ROD | UL

The Finesse Spin with a casting weight of up to 10g is ideal for very small and light lures and especially for fine fishing for perch, chub and trout and offers a slightly more progressive action.

Art.-No.	Length m	CW g	Action	Closed L. cm	Sect.	Guides	Weight g
11213-205	2.05	2-10	extra fast	103	2	8	85

PROREX AGS CHEBUJIG SPIN

NEW

SPINNING ROD | L

The Chebujig rod with a casting weight of 4-15g is equipped with a coloured solid carbon tip for perfect bite detection. This tip supports long casting distances with lighter weights and helps to react on very light and fast bites. The special and progressive tip construction assists to easily inhale the lure.

Art.-No.	Length m	CW g	Action	Closed L. cm	Sect.	Guides	Weight g
11213-225	2.05	4-15	extra fast	116	2	10	105



PROREX AGS JIGSPIN

NEW

SPINNING ROD | ML

The Jigspin model with extra fast tip action was developed for smaller soft lures and metal lures such as bladed jigs, micro spinnerbaits and cover jigs, but is also suitable for fishing with smaller plugs.

Art.-No.	Length m	CW g	Action	Closed L. cm	Sect.	Guides	Weight g
11213-226	2.25	7-21	extra fast	116	2	8	100

PROREX AGS SENSORJIG SPIN

NEW

SPINNING ROD | ML

The Sensor Jig rod in the Prorex AGS range has been designed with a powerful, solid tip and strong backbone. This action is ideal for jigging all types of Softlures in a range between 5g and 25g and perfectly indicates bottom structure and fish contact.

Art.-No.	Length m	CW g	Action	Closed L. cm	Sect.	Guides	Weight g
11213-220	2.25	5-25	extra fast	115	2	9	110



PROREX AGS BAITCAST

NEW

BAITCASTING ROD | L | MH | H | XH

With the four baitcast models in the Prorex AGS series, DAIWA covers the most important areas of modern BC fishing. The Finesse Baitcast up to 14g casting weight easily casts all common smaller rigs and finesse lures, but also excellently twitches small hardbaits. The 80g and 120g models are especially designed for pike fishing with large XL soft lures on shallow rigs and jig heads and offer a slightly longer rear handle for easy operation. The tip nicely loads up during cast and the stiff and powerful backbone supports the hook setting. The 32g casting weight model is ideally suited to zander fishing and pelagic shooting when fishing shallow with slightly smaller and lighter lures. This model offers a carbon rear handle that transfers vibrations to the arm without delay.

Art.-No.	Length m	CW g	Action	Closed L. cm	Sect.	Guides	Weight g
11214-205	2.05	3-14	extra fast	103	2	9	100
11214-215	2.15	9-32	extra fast	116	2	9	115
11214-230	2.30	40-80	extra fast	119	2	10	160
11214-240	2.40	120	extra fast / fast	127	2	10	175

PROREX



PROREX XR SPINNING

HVF
nanoplus

X45

Fuji ALCONITE Tangle Free

AIRSENSOR

- HVF® Nanoplus carbon fiber blank
- X45® carbon fiber construction
- V-Joint® put-over joint
- DAIWA® Air Sensor reel seat
- Fuji® Alconite K-guides

Latest premium rod manufacturing technology. Innovative and reliable components. Evolved blanks and actions – developed by specialists.

The Prorex XR series offers a supreme lineup for pursuing every field of application at modern spin fishing!

The extremely slim and lightweight HVF Nanoplus blanks feature an astonishing handling and enable convenient fishing also during long sessions. The HVF Nanoplus technology cares for a light and perfectly balanced rod weight and leads to a crisp and very fast blank action. The blank instantly transmits every bottom contact and even softest taps straight to the hand and enables a perfect lure feeling. The application of nano particles at the resin elevates the carbon content to a maximum, allowing the design of fast and lightweight rods with high durability.

The exclusive X45 blank design leads to ultimately distortion-proof blanks. After the cast the rods instantly resign to the starting position, allowing long and accurate casts. The V-Joint connection cares for a harmonic bending curve under strain.

The exclusive carbon fiber DAIWA Air Sensor reel seat is ergonomically shaped and significantly contributes to the pleasant handling of these rods.



PROREX XR SPIN

SPINNING ROD | ML | M | MH

The models with casting weights from 10-30g up to 18-84g are perfectly suited when softlures at the jighead or twitchbaits, cranks or spinnerbaits should be applied. Depending on the casting weight you find rods for a large field of application within this rod range: Fishing for perch, chub and trout with small soft- or hardbaits or jigging for pike and zander with a variety of different techniques.

Rods with casting weights up to max. 30g and a length of up to 2.65m are equipped with exclusive EVA carbon fiber handles – perfect handling and lure feeling guaranteed! Rods with a higher casting weight are equipped with an EVA handle to support the rod balance.

Art.-No.	Length m	CW g	Action	Closed L. cm	Sect.	Guides	Weight g
11332-225	2.25	10-30	extra fast	119	2	8	120
11332-240	2.40	10-30	extra fast	127	2	8	115
11332-241	2.40	15-50	extra fast	127	2	8	125
11332-242	2.40	18-84	extra fast	142	2	8	145
11332-270	2.70	5-30	extra fast	142	2	8	130
11332-271	2.70	15-50	extra fast	142	2	8	145



PROREX XR CHEBUJIG

SPINNING ROD | L | SOLID TIP

Both Chebujig rods make fishing for perch and zander an incredible enjoyment. These rods are designed for the use of small and lightweight softbaits at the jighead or Cheburaska system. The solid carbon fiber tip cares for optimal bite detection on long casting distances. The slim but nevertheless robust tip loads perfectly even with very lightweight lures and transmits quick bites till the handle section. Thanks to the strong backbone the hook can be set even over long distances. Equipped with exclusive EVA carbon fiber handle.

Art.-No.	Length m	CW g	Action	Closed L. cm	Sect.	Guides	Weight g
11335-235	2.35	3.5-12	extra fast	122	2	9	115
11335-265	2.65	3.5-12	extra fast	137	2	10	130

PROREX XR FINESSE

SPINNING ROD | LML | TUBULAR TIP

The Prorex XR Finesse rod is perfectly suited for presenting Drop Shot, Free, Texas or Carolina Rigs in a perfect manner. The fast blank with tubular tip and tip action reliably transmits also very soft attacks of cautious predators. This feature is especially important, when lures like crayfish or creature baits are used weightlessly. Equipped with exclusive EVA carbon fiber handle.

Art.-No.	Length m	CW g	Action	Closed L. cm	Sect.	Guides	Weight g
11335-224	2.25	5-21	extra fast	119	2	9	110



PROREX XR ULTRA FAST

SPINNING ROD | M | MH

Both Ultra Fast models are designed for applying lures that produce high pressure, like chatterbaits, deep running or large plugs and heavy soft plastic lures. These rods are also the right choice for fighting string predators also in difficult waters with rough structures like deadwood or extended weedy areas. Perfect handling also at fishing from the boat.

Art.-No.	Length m	CW g	Action	Closed L. cm	Sect.	Guides	Weight g
11332-226	2.25	15-50	ultra fast	119	2	8	130
11332-227	2.25	30-70	ultra fast	119	2	8	135

PROREX XR FINESSE CASTER

BAITCASTING ROD | L | TUBULAR TIP

The Prorex XR Finesse Caster is the perfect add-on to our ultra-modern and lightweight BC reels with SV spool. Using the right combination of reel, rod and line enables astonishing casting distances with lures from 5g on – perfect, when small shads are used or plugs are the go-to lures for zander and perch!

Equipped with exclusive EVA carbon fiber handle.

Art.-No.	Length m	CW g	Action	Closed L. cm	Sect.	Guides	Weight g
11336-220	2.20	5-14	extra fast	114	2	10	120

PROREX XR BAITCAST

BAITCASTING ROD | XH | XXH

The model with 14-42g casting weight represents the perfect all-round baitcasting rod – swimbaits, large plugs and nearly every kind of softbait can be presented in a perfect way with this rod. The ideal choice for zander, pike and large perch.

The 2.40m rod with 40-120g casting weight is the proper companion, when big baits are used for large pikes and zanders. The harmonic blank action enables permanent fatigue-proof fishing and reliable prevents losses during the fight.

Art.-No.	Length m	CW g	Action	Closed L. cm	Sect.	Guides	Weight g
11336-210	2.10	14-42	extra fast	111	2	9	145
11336-245	2.40	40-120	extra fast / fast	127	2	10	165



11336-210



11336-190



11336-220



11336-195



PROREX XR VERTICAL BAITCAST

BAITCASTING ROD | M

The Vertical model has been optimized for the requirements of this particular fishing style. The strong backbone enables you to set the hook effectively also at large depths.

Art.-No.	Length m	CW g	Action	Closed L. cm	Sect.	Guides	Weight g
11336-190	1.90	14-35	extra fast	101	2	9	135

PROREX XR JERK BAITCAST

BAITCASTING ROD | XH | XXH

The Jerkbait rods of the Prorex XR series offer the essential features that are required to present large and heavy jerks in an aggressive way and to set the hook successfully. The stiff blank immediately transfers the twitches to the lure and the tip perfectly loads during the cast to achieve outstanding casting distances. Due to the length of 1.85m and 1.95m, these rods are both suitable for bank and boat fishing.

Art.-No.	Length m	CW g	Action	Closed L. cm	Sect.	Guides	Weight g
11336-185	1.85	30-80	fast	96	2	9	135
11336-195	1.95	40-120	extra fast	104	2	9	150

NEW



PROREX X SPINNING



- HMC+® carbon fiber blank
- Brading-X handle section
- Seaguide® guides

The action of the Prorex X rods has been adapted to the special demands of various modern spinfishing techniques with soft- and hardbaits. The premium HMC+ carbon fiber blank cares for a light weight, fast action and enormous power reserves. The premium spigot joints enable the design of a very slim blank and thus improve the balance significantly. Carbon fiber X-wraps at the blank's surface add stability and an extraordinary look. Very lightweight Seaguide guides with ceramic inlays and special frames, prevent tangling during the cast and contribute significantly to the fast action and great balance of the rod.

The wide range of the Prorex X rod series offers fitting versions for nearly all kind of modern spinfishing.

PROREX X JERK BAITCAST

NEW

BAITCASTING ROD | XH

The Prorex X Jerk model has been specially designed to cope with medium size jerks and even heavy soft lures. The blank perfectly loads during cast and achieves very good casting distances. Thanks to the length of 1.85m, this rod is both suitable for bank and boat fishing.

Art.-No.	Length m	CW g	Action	Closed L. cm	Sect.	Guides	Weight g
11285-185	1.85	30-80	extra fast / fast	96	2	9	145

PROREX X LD CASTER

NEW

BAITCASTING ROD | M | MH | H

The long distance baitcast models in the Prorex X series feature a fast tip action paired with a strong back bone. This allows to benefit from the advantages of a longer rod for casting with a baitcast reel. With a length of 2.65m, handling from the bank becomes considerably easier and compared to shorter rods, you can reach outstanding casting distances, especially with smaller lures. The progressive tip section loads up excellently during the cast and offers sensitive bite detection and hook setting on distance. The available casting weights cover almost all areas of use for local target fish such as perch, zander, pike and asp.

Art.-No.	Length m	CW g	Action	Closed L. cm	Sect.	Guides	Weight g
11285-260	2.65	7-35	extra fast / fast	136	2	11	170
11285-261	2.65	14-56	extra fast / fast	136	2	11	180
11285-262	2.65	28-84	extra fast / fast	136	2	11	185



PROREX X SPIN

SPINNING ROD | LM-H

The Prorex spinning rods are very-well balanced and feature a pleasant handling. The HMC+ carbon fiber blank with fast action and hug power reserves at the backbone enables you to master every fight with confidence! Guides from Seaguide, premium EVA handles and many other innovative components constitute the Prorex X Spin highly attractive rods in the lower price segment.

Art.-No.	Length m	CW g	Action	Closed L. cm	Sect.	Guides	Weight g
11285-241	2.40	7-21	extra fast / fast	123	2	8	120
11285-242	2.40	10-30	extra fast / fast	123	2	8	135
11285-270	2.70	10-30	extra fast / fast	138	2	8	150
11285-243	2.40	15-50	extra fast / fast	123	2	7	145
11285-271	2.70	15-50	extra fast / fast	138	2	8	165
11285-244	2.40	30-70	extra fast / fast	123	2	7	150
11285-272	2.70	30-70	extra fast / fast	138	2	8	170
11285-245	2.40	40-100	extra fast / fast	123	2	7	160
11285-273	2.70	40-100	extra fast / fast	138	2	8	175

PROREX X JIGGERSPIN

JIG SPINNING ROD | ML

The extra-fast jig spinning rod of the Prorex X series are the perfect choice for fishing with light softplastic lures at the jig for perch, zander and pike. The soft tip enables soaking in of the lure and offers optimal sensitivity to scan the ground's surface. The stiff backbone transmits every bite directly to the handle section. The application of jigging rods can significantly reduce the danger of losses during fishing with light lures for perch and zander! This rod type is perfectly made for use with small, lightweight plugs and spoons.

Art.-No.	Length m	CW g	Action	Closed L. cm	Sect.	Guides	Weight g
11287-245	2.40	7-28	extra fast	123	2	8	140
11287-275	2.70	7-28	extra fast	138	2	9	150



PROREX X LIGHT SPIN

SPINNING ROD | L

The Prorex X Light Spin is the perfect buddy for fishing with lightweight spoons, small plugs or softplastic lures at the stream. The fast blank with sensitive tip enables precise casts and a finely adjusted lure presentation even under difficult conditions and in rough terrain. During the fight, the backbone offers enough power reserves to keep fighting fish apart from obstacles and to absorb headbutts and jumps perfectly. Equipped with original Fuji Skeleton reel seat.

Art.-No.	Length m	CW g	Action	Closed L. cm	Sect.	Guides	Weight g
11285-195	1.95	4-15	fast	100	2	8	95
11285-205	2.05	5-20	fast	105	2	8	100

PROREX X SENSOR SPIN

SPINNING ROD | UL | L | ML

The Sensor Spin models have been designed for light and ultralight fishing with softlures and plugs. These kinds of fishing gain popularity and are very successful for perch and zander. Small plastic lures at the Flexi Jig-System, mini plugs and small spoons can be cast precisely over great distances.

During the fight, the fast blank perfectly absorbs fighting fish, guarantees maximum fun and reduces the danger of losses or material fatigue to a minimum.

Equipped with original Fuji Skeleton reel seat.

Art.-No.	Length m	CW g	Action	Closed L. cm	Sect.	Guides	Weight g
11284-210	2.10	1-7	fast	108	2	9	95
11284-230	2.30	1-7	fast	117	2	9	105
11284-270	2.70	1-7	fast	139	2	10	120
11284-211	2.10	2-10	fast	108	2	9	100
11284-231	2.30	2-10	fast	117	2	9	110
11284-271	2.70	2-10	fast	139	2	10	130
11284-212	2.10	3-15	fast	108	2	9	105
11284-232	2.30	3-15	fast	117	2	9	120
11284-272	2.70	3-15	fast	139	2	10	135

PROREX X DROPSHOT

SPINNING ROD | ML

The Prorex X Dropshot rod can be easily identified by its very fast tip action. Due to the sensitive carbon fiber tip, also lightest bites can be detected. The stiff backbone directly transmits the bite to the handle section. With a length of 2.40m, this rod is suited for fishing at the shore as well as from the boat.

Art.-No.	Length m	CW g	Action	Closed L. cm	Sect.	Guides	Weight g
11287-240	2.40	5-21	fast	123	2	9	120



PROREX X EXTRA FAST SPIN

SPINNING ROD | MH | H

The Extra Fast models of the Prorex X series have been developed for fishing with heavy lures, which set up great pressure under water – Chatterbaits, deeply sinking Crankbaits and big shads can be perfectly led with these rods even under difficult fishing conditions. Within heavily vegetated waters as well as in waters with plenty of dead wood, the Extra Fast models can lead a trump. Big fish can be fought uncompromisingly and kept apart from obstacles.

Art.-No.	Length m	CW g	Action	Closed L. cm	Sect.	Guides	Weight g
11286-205	2.05	20-60	ultra fast	105	2	8	135
11286-225	2.25	20-60	ultra fast	115	2	8	145
11286-206	2.05	30-90	ultra fast	105	2	8	140
11286-226	2.25	30-90	ultra fast	115	2	8	155

PROREX X BAITCAST

BAITCASTING ROD | H

The Baitcast model with 2.35m length and up to 84g casting weight enables the application of different lure types for fishing for pike and zander. The well-balanced blank perfectly loads during the cast and thus allows enormous casting distances. Lures like deeply sinking Crankbaits, big plugs and medium to heavy softplastic lures can be retrieved steadily or by aggressive jigging and twitching, without overloading the rod or losing lure control.

Art.-No.	Length m	CW g	Action	Closed L. cm	Sect.	Guides	Weight g
11285-235	2.35	-84	extra fast	120	2	10	145

PROREX X TROLL & BOARD

TROLLING ROD | H

Special rods for modern trolling with or without sideplaner!

The tip action of the Prorex X Troll & Board perfectly buffers waves and thus prevents unwanted activating of the sideplaner. During the fight, the powerful backbone offers enough power reserves to fight biggest predators uncompromisingly from the slowly driving or floating boat.

Of course, this rod is also perfectly suited for presenting big trolling lures without sideplaner. The rod's length of 2.70m cares for sufficient distance to the boat and enable an effortless handling aboard.

Equipped with one-piece EVA handle and original Fuji DPS reel seat.

Art.-No.	Length m	CW g	Action	Closed L. cm	Sect.	Guides	Weight g
11287-246	2.40	-135	medium fast	123	2	8	200
11287-276	2.70	-135	medium fast	138	2	9	225

PROREX X VERTICAL BAITCAST

BAITCASTING ROD | M

The extremely light, very well balanced and powerful blank of the Vertical Baitcast ensures fatigue-free fishing over hours. The innovative Baitcast reel seat is very handy and contributes to an optimal sensitivity during fishing.

The rod's strong tip action guarantees an ideal lure control and an effective setting of the hook even in great depths.

Art.-No.	Length m	CW g	Action	Closed L. cm	Sect.	Guides	Weight g
11285-196	1.95	8-35	fast	100	2	9	150



PROREX S SPINNING

- HMC+® carbon fiber blank
- Premium EVA grip
- Ergonomic reel seat
- Seaguide® guides



PROREX S SPIN

NEW

SPINNING ROD | L-XH

The Prorex S Spin & Baitcast series offers a wide range of specialized predator rods. The Prorex S lineup serves the right rod for almost every area of lure fishing. The very well-balanced and slim blanks made of HMC+ carbon provide fast action and directly transfer bottom, lure and fish contact directly into the handle section. The ergonomically shaped reel seat with side slits enables direct contact with the blank and is comfortable to hold even for long fishing sessions.

The Solid Spin model with a casting weight of 4-18g is equipped with a sensitive solid carbon tip and even perfectly indicates the cautious bites from perch, zander and co – ideal when fishing light rigs or very small softbaits.

The Finesse rod with a casting weight of up to 14g is designed for light and small lures for perch, trout and chub fishing. This rod also copes with small twitchbaits and guarantees a lot of fun!aits.

The Prorex S series is featuring high-quality Seaguide LS guides and offers excellent value for money!

Art.-No.	Length m	CW g	Action	Closed L. cm	Sect.	Guides	Weight g
11282-215	2.15	3-14	extra fast / fast	111	2	9	110
11282-220	2.20	5-18	extra fast / fast	113	2	9	115
11282-210	2.10	5-21	extra fast / fast	108	2	8	115
11282-240	2.40	5-21	extra fast / fast	123	2	8	120
11282-241	2.40	10-30	extra fast / fast	123	2	8	125
11282-242	2.40	15-50	extra fast / fast	123	2	7	145
11282-243	2.40	30-70	extra fast / fast	123	2	7	150
11282-244	2.40	40-90	extra fast / fast	123	2	7	160
11282-245	2.40	50-110	extra fast / fast	123	2	7	170
11282-270	2.70	5-30	extra fast / fast	139	2	8	150
11282-271	2.70	15-50	extra fast / fast	139	2	8	165
11282-272	2.70	30-70	extra fast / fast	139	2	8	170
11282-273	2.70	50-110	extra fast / fast	139	2	8	185
11282-290	2.90	20-60	extra fast / fast	149	2	9	180



PROREX S BAITCAST

NEW

BAITCASTING ROD | L | ML | M | MH

The lineup of Prorex S baitcasting rods leaves almost nothing to be desired and offers the right model for almost every common predator and fishing style. The two parabolic Crank models with 4-18g and 7-28g are particularly suitable for lures creating heavy water drag, such as deep-running plugs and chatter baits.

The Prorex S series is featuring high-quality Seaguide LS guides and offers excellent value for money!

Art.-No.	Length m	CW g	Action	Closed L. cm	Sect.	Guides	Weight g
11283-205	2.05	5-14	extra fast / fast	106	2	9	120
11283-210	2.10	14-42	extra fast / fast	108	2	9	135
11283-225	2.25	30-70	extra fast / fast	116	2	10	145
11283-211	2.10	4-18	progressive	110	2	9	150
11283-212	2.10	7-28	progressive	110	2	9	175



PROREX UL FINESSE BRAID

BRAIDED LINE | CHARTREUSE

With the Prorex UL Finesse Braid, DAIWA offers a very thin Japanese braid, which performs outstandingly at ultra-light and finesse fishing. This excellent line is particularly useful when fishing with extremely small lures and jigheads for perch, chub and trout. The diameter indication at the 135m-spool is declared according to Japanese PE specifications (no mm count!).

- High knot strength
- High abrasion resistance
- Made in Japan



Art.-No.	Color	Capacity m	PE PE No.	Strength kg	Strength lb
12996-002	chartreuse	135	0.25	1.80	3.9
12996-003	chartreuse	135	0.3	2.10	4.7
12996-004	chartreuse	135	0.4	2.80	6.0
12996-006	chartreuse	135	0.6	4.30	9.4



- Sinking
- High abrasion resistance
- Little stretch
- Almost invisible under water
- Very high suppleness
- Made in Japan



PROREX FLUOROCARBON SUPER SOFT

LEADER LINE | CLEAR

The Prorex leader material is made in Japan and highly abrasion resistant but very supple at the same time. Perfect as leader material for fishing in fresh water and at sea fishing.

This leader material from the Prorex range offers an outstanding price-performance ratio!

Art.-No.	Color	Capacity m	Ø mm	Strength kg	Strength lb
12995-014	clear	50	0.14	1.70	3.7
12995-016	clear	50	0.16	2.00	4.4
12995-018	clear	50	0.18	2.50	5.5
12995-020	clear	50	0.20	2.90	6.4
12995-023	clear	50	0.23	4.00	8.8
12995-026	clear	50	0.26	4.80	10.6
12995-030	clear	50	0.30	6.80	15.0
12995-033	clear	50	0.33	7.40	16.3
12995-036	clear	50	0.36	9.30	20.5
12995-040	clear	40	0.40	10.40	22.9
12995-045	clear	28	0.45	12.80	28.2
12995-050	clear	21	0.50	14.60	32.2
12995-055	clear	17	0.55	16.40	36.2
12995-060	clear	15	0.60	20.40	45.0
12995-070	clear	15	0.70	24.60	54.2
12995-080	clear	15	0.80	29.20	64.4
12995-090	clear	15	0.90	36.00	79.4
12995-100	clear	15	1.00	45.00	99.2



PROREX CHIBI FUKU FUKU CRANK

NEW

CRANKBAIT

The small and tiny brother of the Fuku 1 inside the Prorex crank range. This lure is perfectly suited to target Perch and Zander and quickly dives to depth up to 1m. Thanks to the long diving lip, this lure actively avoids being snagged on obstacles.

In combination with the high buoyancy this lure can be easily used to fish around underwater rocks and reefs – the lure quickly dives to surface on loose fishing line and will not snag. The unique body design avoids tangled hooks.



- Category: mini crankbait
- Hooks: 2 SaqSas treble hooks
- Type: floating
- Diving type: shallow runner
- Diving depth: ca. 1.0-1.5m

Art.-No.	Color	Length mm	Weight g	Content pc.
15263-401	ghost yellow ayu	41	6.5	1
15263-402	chrome wakasagi	41	6.5	1
15263-403	firetiger	41	6.5	1
15263-404	special chartreuse	41	6.5	1
15263-405	gizzard shad	41	6.5	1
15263-406	yummi	41	6.5	1
15263-407	black gold	41	6.5	1
15263-408	spawn ayu	41	6.5	1
15263-409	blue tiger	41	6.5	1
15263-410	ghost purple wakasagi	41	6.5	1
15263-411	special shiner	41	6.5	1
15263-412	blue perch	41	6.5	1



PROREX CHINING BUG 55F

NEW

POPPER | FLOATING | TOP WATER

Extra small, floating Popper to target Perch and Asp featuring a unique Tuning-possibility. Thanks to its compact shape and construction, the Prorex Chining Bug achieves long casting distance and provokes outstanding bite frequency especially by the walk-the-dog technique. The small body in combination with the silicone legs at the rear provide a bug shape silhouette that results into improved bite reaction. The integrated „3-Eye“ Tuning plate at the rear enables additional usage of silicone skirts and adaptation of the centre of gravity by changing the rear treble's hook position to 3 different positions. Perfectly suited to adapt on either calm or rough water conditions.

Art.-No.	Color	Length mm	Weight g	Content pc.
15265-701	eagle red berry	70	12.9	1
15265-702	green gold red tail	70	12.9	1



- Category: popper
- Hooks: 2 SaqSas treble hooks
- Type: floating
- Diving type: top water



PROREX FUKU 1 CRANK

NEW

CRANKBAIT

This classic and compact designed crank bait in the Prorex family instantly dives down to depth (up to 1m) and provides a strong wiggling and rolling action – perfectly suited for slow retrieve! Thanks to the buoyancy and snaggles design, this lure is also designed to be closely fish around underwater obstacles – once touched the lure immediately pops up on lose fishing line and doesn't snag underwater. Thanks to the special body design, the hooks will not tangle despite located close together. A real performer for Perch, Zander and Pike. Silent construction.



- Category: crankbait
- Hooks: 2 SaqSas treble hooks
- Type: floating
- Diving type: medium deep runner
- Diving depth: ca. 1.0-1.5m

Art.-No.	Color	Length mm	Weight g	Content pc.
15262-501	ghost yellow ayu	55	14.5	1
15262-502	chrome wakasagi	55	14.5	1
15262-503	firetiger	55	14.5	1
15262-504	special chartreuse	55	14.5	1
15262-505	gizzard shad	55	14.5	1
15262-506	yummi	55	14.5	1
15262-507	black gold	55	14.5	1
15262-508	spawn ayu	55	14.5	1
15262-509	blue tiger	55	14.5	1
15262-510	ghost purple wakasagi	55	14.5	1
15262-511	special shiner	55	14.5	1
15262-512	blue perch	55	14.5	1



ghost yellow ayu



chrome wakasagi



firetiger



special chartreuse



gizzard shad



yummi



black gold



spawn ayu



blue tiger



ghost purple wakasagi



special shiner



blue perch



PROREX FUKU ZERO CRANK

NEW

CRANKBAIT

This floating, compact designed crank in the Prorex series was specially designed to be fished over weed beds or in very shallow waters. The Zero (0) Crank rides on the surface film of the water and provides mind blowing bites on the surface. Perfectly suited once weed rises close to the surface and standard lures can't be used and for fishing in between fields of water lilies. A light sound rattle positioned in the upper part of the body creates additional attraction and attention. Thanks to the compact body shape, this lure can be casted with accuracy even on long distance and provides an outstanding, rolling and snaky action.

- **Category:** crankbait
- **Hooks:** 2 SaqSas treble hooks
- **Type:** floating
- **Diving type:** top water



Art.-No.	Color	Length mm	Weight g	Content pc.
15261-501	ghost yellow ayu	54	14.0	1
15261-502	chrome wakasagi	54	14.0	1
15261-503	firetiger	54	14.0	1
15261-504	special chartreuse	54	14.0	1
15261-505	gizzard shad	54	14.0	1
15261-506	yummi	54	14.0	1
15261-507	black gold	54	14.0	1
15261-508	spawn ayu	54	14.0	1
15261-509	blue tiger	54	14.0	1
15261-510	ghost purple wakasagi	54	14.0	1
15261-511	special shiner	54	14.0	1
15261-512	blue perch	54	14.0	1



PROREX FUKU HAYATE CRANK

NEW

CRANKBAIT

The Prorex floating deep diver in Fuku's retro design range from Japan dives up to 2m depth. The Fuku Hayate is specially designed to target large Perch and Zander and convinces by it's strong flanking and rolling action. The lures immediately dives down to the desired depth and reduces water drag – perfect once light tackle is used. The semi-silent construction provides only very light and tiny rattling sound by its inner balance weight that improves the number of bites in heavily fished waters.



Art.-No.	Color	Length mm	Weight g	Content pc.
15260-501	ghost yellow ayu	55	7.0	1
15260-502	chrome wakasagi	55	7.0	1
15260-503	firetiger	55	7.0	1
15260-504	special chartreuse	55	7.0	1
15260-505	gizzard shad	55	7.0	1
15260-506	yummi	55	7.0	1
15260-507	black gold	55	7.0	1
15260-508	spawn ayu	55	7.0	1
15260-509	blue tiger	55	7.0	1
15260-510	ghost purple wakasagi	55	7.0	1
15260-511	special shiner	55	7.0	1
15260-512	blue perch	55	7.0	1

- Category: crankbait
- Hooks: 2 SaqSas treble hooks
- Type: floating
- Diving type: medium deep runner
- Diving depth: ca. 1.5-2.0m



PROREX SWIFT CRANK 250

NEW

CRANKBAIT

The Deep Diver within the latest Prorex Crank family – achieves up to 2.5m running depth. Perfectly suited for fishing close to bottom or for bottom bouncing. The diving lip construction features a special „Centre Bone Design” – offering an increased strength area in the middle of the lip and thinner construction at the edges to improve strength for frequent bottom contact and enable faster lure reaction on twitching and jerking with your rod tip. The balance weight at the rear part of the body supports long casting distances and is fixed by a magnet inside the body during retrieve to provide a constant and stable running action. Thanks to the body size of 70mm, this lure is a real all-round lure to mainly target Perch and Zander but easily copes with lighter Pike fishing as well.



- Hooks: 2 SaqSas treble hooks
- Type: floating
- Diving type: medium deep runner
- Diving depth: up to ca. 2.5m

Art.-No.	Color	Length mm	Weight g	Content pc.
15264-701	ghost yellow ayu	70	12.9	1
15264-702	chrome wakasagi	70	12.9	1
15264-703	firetiger	70	12.9	1
15264-704	special chartreuse	70	12.9	1
15264-705	gizzard shad	70	12.9	1
15264-706	yummi	70	12.9	1
15264-707	black gold	70	12.9	1
15264-708	spawn ayu	70	12.9	1
15264-709	blue tiger	70	12.9	1
15264-710	ghost purple wakasagi	70	12.9	1
15264-711	special shiner	70	12.9	1
15264-712	blue perch	70	12.9	1



ghost yellow ayu



chrome wakasagi



firetiger



special chartreuse



gizzard shad



yummi



black gold



spawn ayu



blue tiger



ghost purple wakasagi



special shiner



blue perch



DUCKFIN

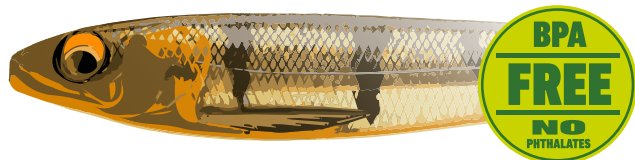

PROREX DUCKFIN SHAD SET

We offer the successful and popular original DAIWA DuckFin Shad also in a set of established colors.

Together with our teamglers we did choose color combinations that normally always score. The Nature set for clear waters and challenging days – the UV set for muddy water and reaction strikes and the UV & Nature set for every situation. Phthalate-free!

The Prorex DuckFin Shad sets are available in the following color sortings:

- Nature Mix (gold perch, dirty roach, pearl mother) UV Mix (UV green chartreuse, UV chartreuse, UV pearl) UV & Nature Mix (chiayu, UV pearl, burning perch)

PROREX DUCKFIN SHAD | NATURE SET

SOFT SHAD ASSORTMENT



Size: **6.0cm (2.5")** Color: Gold Perch x 3 Pearl Mother x 3 Dirty Roach x 3 **9 pcs.**

Size: **9.0cm (3.5")** Color: Gold Perch x 2 Pearl Mother x 3 Dirty Roach x 2 **7 pcs.**

Size: **12.5cm (5")** Color: Gold Perch x 2 Pearl Mother x 1 Dirty Roach x 2 **5 pcs.**



PROREX DUCKFIN SHAD | UV SET

SOFT SHAD ASSORTMENT



Size: **6.0cm (2.5")** Color: UV Green Chartreuse x 3 UV Pearl x 3 UV Chartreuse x 3 **9 pcs.**

Size: **9.0cm (3.5")** Color: UV Green Chartreuse x 2 UV Pearl x 3 UV Chartreuse x 2 **7 pcs.**

Size: **12.5cm (5")** Color: UV Green Chartreuse x 2 UV Pearl x 1 UV Chartreuse x 2 **5 pcs.**



PROREX DUCKFIN SHAD | UV & NATURE SET

SOFT SHAD ASSORTMENT



Size: **6.0cm (2.5")** Color: Chiayu x 3 Burning Perch x 3 UV Pearl x 3 **9 pcs.**

Size: **9.0cm (3.5")** Color: Chiayu x 2 Burning Perch x 3 UV Pearl x 2 **7 pcs.**

Size: **12.5cm (5")** Color: Chiayu x 2 Burning Perch x 1 UV Pearl x 2 **5 pcs.**



Art.-No.	Length cm	Content Set pc.
15142-600	6.0	9
15142-900	9.0	7
15142-100	12.5	5

Art.-No.	Length cm	Content Set pc.
15142-601	6.0	9
15142-901	9.0	7
15142-101	12.5	5

Art.-No.	Length cm	Content Set pc.
15142-602	6.0	9
15142-902	9.0	7
15142-102	12.5	5



LAZY SHAD

PROREX LAZY SHAD

The Lazy Shad from the Prorex range has been developed together with the DAIWA Scandinavia team. This lure comes into action even at low speed and therefore is perfectly suited for using shallow rigs. The high profile together with the large paddle tail provokes strong flanking. This lure already has been a show-stopper at some pike competitions in Scandinavia! The 16cm version is also perfectly suited for targeting large zanders!

PROREX LAZY SHAD | 160MM

SHAD

Art.-No.	Color	Length cm	Weight g	Content pc.
15225-102	olive roach UV	16.0	54.0	1
15225-104	motor oil burbot UV	16.0	54.0	1
15225-105	magic green	16.0	54.0	1
15225-107	ghost golden perch	16.0	54.0	1
15225-109	ayu	16.0	54.0	1
15225-110	natural perch	16.0	54.0	1
15225-112	headlight	16.0	54.0	1
15225-113	UV pink belly	16.0	54.0	1
15225-119	pearl yellow	16.0	54.0	1

PROREX LAZY SHAD | 200MM

SHAD

Art.-No.	Color	Length cm	Weight g	Content pc.
15225-002	olive roach UV	20.0	85.0	1
15225-004	motor oil burbot UV	20.0	85.0	1
15225-005	magic green	20.0	85.0	1
15225-007	ghost golden perch	20.0	85.0	1
15225-009	ayu	20.0	85.0	1
15225-010	natural perch	20.0	85.0	1
15225-012	headlight	20.0	85.0	1
15225-013	UV pink belly	20.0	85.0	1
15225-019	pearl yellow	20.0	85.0	1



PROREX TG SPIN JIG NEW

This tiny Prorex Spin Jig made by DAIWA was specially designed to target Perch. Thanks to the compact body, this lure achieves huge casting distances and drops immediately to desire depth. During retrieve, you can feel the vibration up to your rod handle. This lure features a heavily vibrating Colorado blade at the rear end and a side-to-side flanking action of it's body. The lure nearly fully eliminates tangles during cast and fall by the rear end's tube construction and hook position.

The 14g version is made by Tungsten, the 21g version is made by Zinc and also provides good results on Pike and Asp.

- **Category:** jig spinnerbait
- **Hook:** treble hook
- **Sinking behaviour:** fast sinking



PROREX TG SPIN JIG NEW

JIG SPINNERBAIT

Art.-No.	Color	Color (Blade)	Treble Size	Weight g
15448-014	ayu	silver	8	14.0
15448-114	golden shiner	matt orange	8	14.0
15448-214	rusty shad	silver	8	14.0
15448-314	gold nugget	gold	8	14.0
15448-414	green golden roach	gold	8	14.0
15448-514	matt firetiger/black stripes	silver	8	14.0
15448-614	pink iwashi	silver	8	14.0
15448-714	chartreuse sniper	silver	8	14.0
15448-814	3D blue smelt	silver	8	14.0
15448-914	silver fish	silver	8	14.0
15449-014	MO burbot UV	gold	8	14.0



ayu



golden shiner



rusty shad



gold nugget



green golden roach



matt firetiger



pink iwashi



chartreuse sniper



3D blue smelt



silver fish



MO burbot UV



PROREX REAL SLIM SHADY LIVE NEW

The proven Prorex Slim Shady made by DAIWA is now available in realistic 3D design Live Print coloration. Extremely close to a real fish. Thanks to the special surface and material treatment, these colors are shimmering greenish, golden or bluish on the surface. This special color selection has now proven its effectiveness in various field tests all over Europe. A Real Slim Shady!

PROREX REAL SLIM SHADY LIVE | 75MM NEW

SHAD | DISPLAY BOX

Art.-No.	Color	Length cm	Weight g	PU pc.
15100-120	baby zander	7.5	3.3	60
15100-121	gold perch	7.5	3.3	60
15100-122	real perch	7.5	3.3	60

PROREX REAL SLIM SHADY LIVE | 105MM NEW

SHAD | DISPLAY BOX

Art.-No.	Color	Length cm	Weight g	PU pc.
15100-220	baby zander	10.5	8.0	48
15100-221	gold perch	10.5	8.0	48
15100-222	real perch	10.5	8.0	48

PROREX REAL SLIM SHADY LIVE | 135MM NEW

SHAD | DISPLAY BOX

Art.-No.	Color	Length cm	Weight g	PU pc.
15100-320	baby zander	13.5	13.5	48
15100-321	gold perch	13.5	13.5	48
15100-322	real perch	13.5	13.5	48

PROREX REAL SLIM SHADY LIVE | 160MM NEW

SHAD | DISPLAY BOX

Art.-No.	Color	Length cm	Weight g	PU pc.
15100-420	baby zander	16.0	25.5	36
15100-421	gold perch	16.0	25.5	36
15100-422	real perch	16.0	25.5	36

PROREX REAL SLIM SHADY | LIVE SET NEW

SOFT SHAD ASSORTMENT

The proven Prorex Slim Shady made by DAIWA is now also available in realistic 3D Live Print designs. Very effective and catchy! Baby Zander, Gold Perch and Real Perch design.

Art.-No.	Color	Length cm	Weight g	Content pc.
15100-615	live set	7.5	20.0	5
15100-715	live set	10.5	32.0	4
15100-815	live set	13.5	56.0	4
15100-915	live set	16.0	78.0	3

The Real SLIM SHADY

3D REAL PATTERN SOFTBAITS

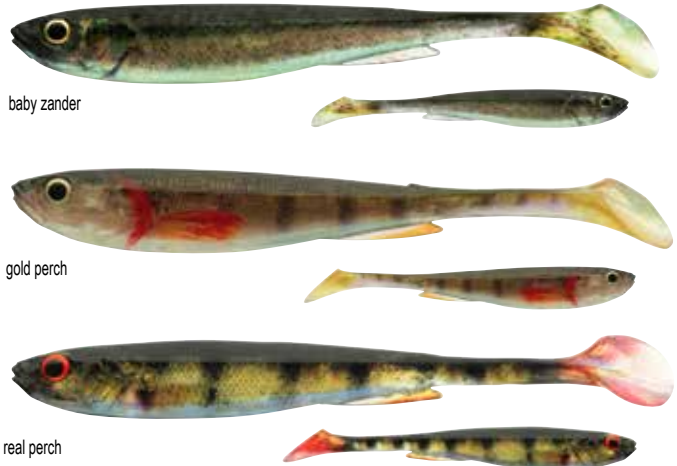

SLIM SHADY

PROREX SLIM SHADY

The Slim Shady from the DAIWA Prorex range convinces by its catchiness. The slim body shape imitates the main bait fish of most predators – bleaks and freshwater smelts. Due to 45 degrees of the tail, the Slim Shady is not too conspicuous and strongly flanking within running waters and thus is ideally suited for fishing in channels or rivers - as well as silent waters. The lure shows slightly flanking movements and imitates a hurt bait fish. Due to the slim body shape, this lure also can be fished effortlessly, because the resistance in the current is minimized. With enduring, painted eyes. The Slim Shady has proven its catchiness during testing phase and has convinced many zander, pikes and perches!

- Available in 4 sizes – 7.5, 10.5, 13.5 und 16cm – and 10 different colors.
- Phtalat-free rubber.



golden shiner



chart. shocker



flash minnow



ghost fire tiger



white ghost



motor oil tiger



wakasagi



natural uv perch



ayu



natural green roach

PROREX SLIM SHADY | 75MM

SHAD | DISPLAY BOX

Art.-No.	Color	Length cm	Weight g	PU pc.
15100-101	golden shiner	7.5	3.3	60
15100-103	flash minnow	7.5	3.3	60
15100-107	white ghost	7.5	3.3	60
15100-108	wakasagi	7.5	3.3	60
15100-109	ayu	7.5	3.3	60
15100-110	chartreuse shocker	7.5	3.3	60
15100-114	ghost firetiger	7.5	3.3	60
15100-117	motor oil tiger	7.5	3.3	60
15100-118	natural UV perch	7.5	3.3	60
15100-119	natural green roach	7.5	3.3	60

PROREX SLIM SHADY | 105MM

SHAD | DISPLAY BOX

Art.-No.	Color	Length cm	Weight g	PU pc.
15100-201	golden shiner	10.5	8.0	48
15100-203	flash minnow	10.5	8.0	48
15100-207	white ghost	10.5	8.0	48
15100-208	wakasagi	10.5	8.0	48
15100-209	ayu	10.5	8.0	48
15100-210	chartreuse shocker	10.5	8.0	48
15100-214	ghost firetiger	10.5	8.0	48
15100-217	motor oil tiger	10.5	8.0	48
15100-218	natural UV perch	10.5	8.0	48
15100-219	natural green roach	10.5	8.0	48

PROREX SLIM SHADY | 135MM

SHAD | DISPLAY BOX

Art.-No.	Color	Length cm	Weight g	PU pc.
15100-301	golden shiner	13.5	13.5	48
15100-303	flash minnow	13.5	13.5	48
15100-307	white ghost	13.5	13.5	48
15100-308	wakasagi	13.5	13.5	48
15100-309	ayu	13.5	13.5	48
15100-310	chartreuse shocker	13.5	13.5	48
15100-314	ghost firetiger	13.5	13.5	48
15100-317	motor oil tiger	13.5	13.5	48
15100-318	natural UV perch	13.5	13.5	48
15100-319	natural green roach	13.5	13.5	48

PROREX SLIM SHADY | 160MM

SHAD | DISPLAY BOX

Art.-No.	Color	Length cm	Weight g	PU pc.
15100-401	golden shiner	16.0	25.5	36
15100-403	flash minnow	16.0	25.5	36
15100-407	white ghost	16.0	25.5	36
15100-408	wakasagi	16.0	25.5	36
15100-409	ayu	16.0	25.5	36
15100-410	chartreuse shocker	16.0	25.5	36
15100-414	ghost firetiger	16.0	25.5	36
15100-417	motor oil tiger	16.0	25.5	36
15100-418	natural UV perch	16.0	25.5	36
15100-419	natural green roach	16.0	25.5	36

The catchy Slim Shady is also available as color set. With these sets, you cover nearly all kind of waters from very clear to very murky and can easily find out the actual color preferences.

PROREX SLIM SHADY | NATURE SET

SOFT SHAD ASSORTMENT



- The Prorex Slim Shady Nature set is available in following colors:
- 7.5cm (2x ayu, 1x wakasagi, 1x flash minnow, 1x golden shiner)
- 10.5cm (1x ayu, 1x wakasagi, 1x flash minnow, 1x golden shiner)
- 13.5cm (1x ayu, 1x wakasagi, 1x flash minnow, 1x golden shiner)
- 16.0cm (1x ayu, 1x golden shiner, 1x wakasagi)

Art.-No.	Color	Length cm	Weight g	Content Set pc.
15100-600	color mix 1	7.5	20.0	5
15100-700	color mix 1	10.5	32.0	4
15100-800	color mix 1	13.5	56.0	4
15100-900	color mix 1	16.0	78.0	3

PROREX SLIM SHADY | FLASH SET

SOFT SHAD ASSORTMENT



- The Prorex Slim Shady Flash set is available in following colors:
- 7.5cm (1x ghost firetiger, 2x real firetiger, 1x chartreuse shocker, 1x natural UV perch)
- 10.5cm (1x ghost firetiger, 1x real firetiger, 1x chartreuse shocker, 1x natural UV perch)
- 13.5cm (1x ghost firetiger, 1x real firetiger, 1x chartreuse shocker, 1x natural UV perch)
- 16.0cm (1x ghost firetiger, 1x real firetiger, 1x chartreuse shocker)

Art.-No.	Color	Length cm	Weight g	Content pc.
15100-601	color mix 2	7.5	20.0	5
15100-701	color mix 2	10.5	32.0	4
15100-801	color mix 2	13.5	56.0	4
15100-901	color mix 2	16.0	78.0	3



PROREX BELLY SHAD NEW

The PX Belly Shad was primarily designed to target perch and zander. The 90 degree angled paddle tail supports a slight flanking and wobbling action even under slow retrieve. Perfectly suited to be fished in Stillwater, rivers and channels. The compact high back design provides long casting distance and imitates the shape of common prey fish like small perch or roach. The available mix of 10 different natural and flashy colors fits to all water conditions and types. With painted eyes.

Available in 3 size: 6cm, 8.5cm und 11cm.



PROREX BELLY SHAD | 60MM NEW

SHAD | DISPLAY BOX

Art.-No.	Color	Length cm	Weight g	PU pc.
15320-101	golden shiner	6.0	2.0	60
15320-103	flash minnow	6.0	2.0	60
15320-107	white ghost	6.0	2.0	60
15320-108	wakasagi	6.0	2.0	60
15320-109	ayu	6.0	2.0	60
15320-110	chartreuse shocker	6.0	2.0	60
15320-114	ghost firetiger	6.0	2.0	60
15320-117	motor oil tiger	6.0	2.0	60
15320-118	natural UV perch	6.0	2.0	60
15320-119	natural green roach	6.0	2.0	60

Belly Shad



golden shiner



flash minnow



white ghost



wakasagi



ayu



chartreuse shocker



ghost firetiger



motor oil tiger



natural UV perch



natural green roach



PROREX BELLY SHAD | 85MM

NEW

SHAD | DISPLAY BOX

Art.-No.	Color	Length cm	Weight g	PU pc.
15320-201	golden shiner	8.5	4.0	48
15320-203	flash minnow	8.5	4.0	48
15320-207	white ghost	8.5	4.0	48
15320-208	wakasagi	8.5	4.0	48
15320-209	ayu	8.5	4.0	48
15320-210	chartreuse shocker	8.5	4.0	48
15320-214	ghost firetiger	8.5	4.0	48
15320-217	motor oil tiger	8.5	4.0	48
15320-218	natural UV perch	8.5	4.0	48
15320-219	natural green roach	8.5	4.0	48



PROREX BELLY SHAD | 110MM

NEW

SHAD | DISPLAY BOX

Art.-No.	Color	Length cm	Weight g	PU pc.
15320-301	golden shiner	11.0	12.0	48
15320-303	flash minnow	11.0	12.0	48
15320-307	white ghost	11.0	12.0	48
15320-308	wakasagi	11.0	12.0	48
15320-309	ayu	11.0	12.0	48
15320-310	chartreuse shocker	11.0	12.0	48
15320-314	ghost firetiger	11.0	12.0	48
15320-317	motor oil tiger	11.0	12.0	48
15320-318	natural UV perch	11.0	12.0	48
15320-319	natural green roach	11.0	12.0	48



Belly shad

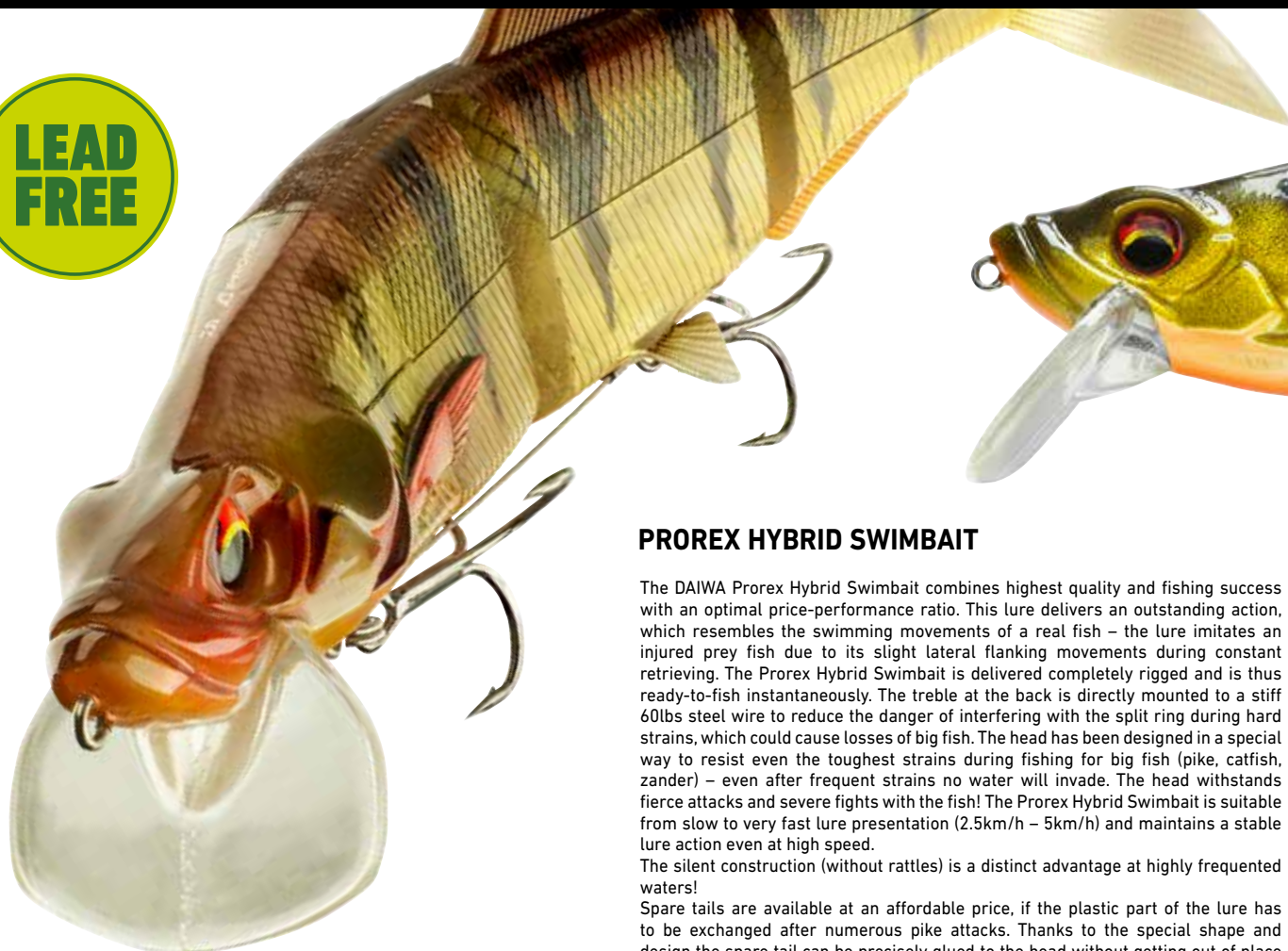

PROREX HYBRID SWIMBAIT

The DAIWA Prorex Hybrid SwimBait combines highest quality and fishing success with an optimal price-performance ratio. This lure delivers an outstanding action, which resembles the swimming movements of a real fish – the lure imitates an injured prey fish due to its slight lateral flanking movements during constant retrieving. The Prorex Hybrid SwimBait is delivered completely rigged and is thus ready-to-fish instantaneously. The treble at the back is directly mounted to a stiff 60lbs steel wire to reduce the danger of interfering with the split ring during hard strains, which could cause losses of big fish. The head has been designed in a special way to resist even the toughest strains during fishing for big fish (pike, catfish, zander) – even after frequent strains no water will invade. The head withstands fierce attacks and severe fights with the fish! The Prorex Hybrid SwimBait is suitable from slow to very fast lure presentation (2.5km/h – 5km/h) and maintains a stable lure action even at high speed.

The silent construction (without rattles) is a distinct advantage at highly frequented waters!

Spare tails are available at an affordable price, if the plastic part of the lure has to be exchanged after numerous pike attacks. Thanks to the special shape and design the spare tail can be precisely glued to the head without getting out of place (recommendation: Loctite glue type 406).

Size comparison



25cm



PROREX HYBRID SWIMBAIT | 180SF

HYBRID LURE | SINKING | MEDIUM DEEP RUNNER

- Type: silent (without rattles)
- Hooks: 2 treble hooks
- Type: sinking
- Diving type: medium deep runner
- Diving depth: ca. 2.0m, trolled up to ca. 3.5m
- Waters: silent & current waters
- Presentation techniques: spinning, trolling
- Speed: slow and fast
- Target fishes: zander, pike, catfish

Art.-No.	Color	Length cm	Treble Size	Weight g	Content pc.
15418-001	firetiger	18.0	1	50.0	1
15418-002	golden shiner	18.0	1	50.0	1
15418-011	perch	18.0	1	50.0	1

PROREX HYBRID SWIMBAIT | 250SF

HYBRID LURE | SINKING | DEEP RUNNER

- Type: silent (without rattles)
- Hooks: 2 treble hooks
- Type: sinking
- Diving type: deep runner
- Diving depth: ca. 2.5m, trolled up to ca. 5.0m
- Waters: silent & current waters
- Presentation techniques: spinning, trolling
- Speed: slow and fast
- Target fishes: zander, pike, catfish

Art.-No.	Color	Length cm	Treble Size	Weight g	Content pc.
15425-001	firetiger	25.0	2/0	125.0	1
15425-002	golden shiner	25.0	2/0	125.0	1
15425-003	swedish blue	25.0	2/0	125.0	1
15425-005	ghost purple ayu	25.0	2/0	125.0	1
15425-007	rainbow trout	25.0	2/0	125.0	1
15425-010	ayu	25.0	2/0	125.0	1
15425-011	perch	25.0	2/0	125.0	1



firetiger



golden shiner



swedish blue



rainbow trout



ghost purple ayu



perch



ayu

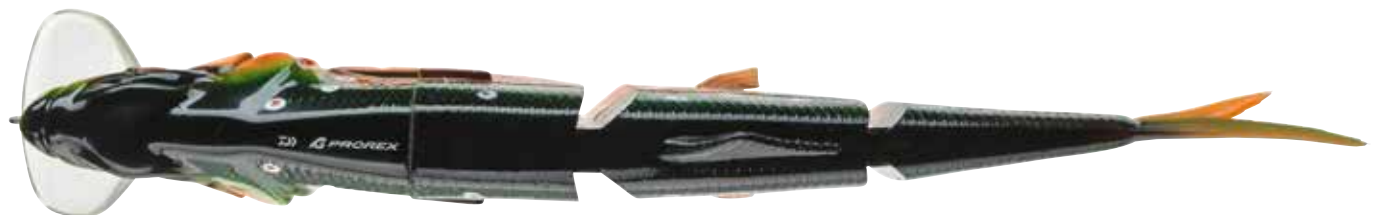

PROREX HYBRID SWIMBAIT | 180SF | SPARE TAILS

Spare tails for 18cm Hybrid Swimbait

Art.-No.	Color	Length cm	Content pc.
15418-102	golden shiner	18.0	1
15418-103	swedish blue	18.0	1
15418-107	rainbow trout	18.0	1
15418-110	ayu	18.0	1
15418-111	perch	18.0	1
15418-112	ghost lime	18.0	1

PROREX HYBRID SWIMBAIT | 250SF | SPARE TAILS

Spare tails for 25cm Hybrid Swimbait

Art.-No.	Color	Length cm	Content pc.
15425-107	rainbow trout	25.0	1
15425-111	perch	25.0	1
15425-112	ghost lime	25.0	1



PROREX PELAGIC HEAD

JIGHEAD

Realistic, fish-shaped screw-in head. Can easily be screwed into any soft plastic lure. Due to 6 different colors, the head can easily be aligned to nearly all kind of lures. The top side has a broad profile, which cares for a slight, additional lure action during retrieving. The big eyelet at the head also fits with split rings. With extra thick varnish. Lead-free.

Available in 30g, 40g and 50g.

Equipment:

- Lead-free design

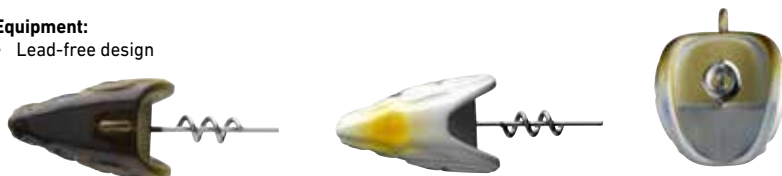

Art.-No.	Color	Weight g	Content pc.
15330-030	ayu	30.0	1
15330-040	ayu	40.0	1
15330-050	ayu	50.0	1
15330-130	chartreuse	30.0	1
15330-140	chartreuse	40.0	1
15330-150	chartreuse	50.0	1
15330-230	golden shiner	30.0	1
15330-240	golden shiner	40.0	1
15330-250	golden shiner	50.0	1
15330-330	game changer pearl	30.0	1
15330-340	game changer pearl	40.0	1
15330-350	game changer pearl	50.0	1
15330-430	muddy green	30.0	1
15330-440	muddy green	40.0	1
15330-450	muddy green	50.0	1
15330-530	roach	30.0	1
15330-540	roach	40.0	1
15330-550	roach	50.0	1

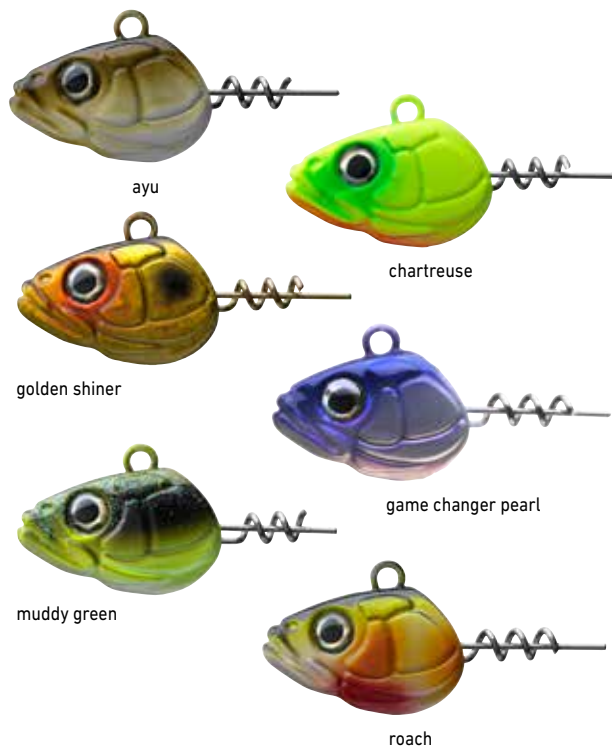

PROREX MICRO SPINNER FISH TG

MICRO-SPINNERBAIT

Very small micro spinnerbait with tungsten body. Runs very steady even in tough currents and catches especially perches and trouts. Due to the silicone ring at the wire, this lure can also easily be fished with swivel and carabiner, without slipping off. Due to the light weight, the Prorex Micro Spinner Jig is also perfectly suited for fishing in vegetated areas. Lead-free.

- **Category:** micro-spinnerbait
- **Type:** slow sinking
- **Waters:** silent & current waters
- **Speed:** slow and fast
- **Target fishes:** perch, trout, chub

Equipment:

- Lead-free design

Art.-No.	Color	Treble Size	Weight g
15153-005	chromed orange	10	5.3
15153-105	shiny ayu	10	5.3
15153-305	firetiger	10	5.3
15153-505	katakuchi	10	5.3
15153-705	blue red tail	10	5.3



V-MARLEY



PROREX V-MARLEY PELAGIC SHAD

SHAD

This new and very catchy pelagic and vertical lure combines the advantages of a V-tail with fringes, which dance even under slow currents. The special, ultra-thin pelvic fin even finely pulsates during retrieving stops and provokes attacks.

The thin profile offers little resilience during the bite and thus can easily be inhaled by zander & Co. The realistic, lead-free head with a weight of 40g supports the strong profile, produces slight wave motions during retrieving and can be screwed to the lure. With extra strong and sharp SaqSas Assist hook at the back.

The lure is delivered ready-to-fish and can be used immediately. Phthalat-free rubber. Available in 8 colors. Length: 21cm.

Hook: SaqSas treble hook

Equipment:

- Lead-free design

Art.-No.	Color	Length cm	Treble Size	Weight g	Content pc.
15227-001	firetiger	21.0	1/0	80.0	1
15227-002	ayu	21.0	1/0	80.0	1
15227-003	wakasagi	21.0	1/0	80.0	1
15227-004	golden shiner	21.0	1/0	80.0	1
15227-005	real mud roach	21.0	1/0	80.0	1
15227-006	natural UV perch	21.0	1/0	80.0	1
15227-007	game changer	21.0	1/0	80.0	1
15227-008	white ghost	21.0	1/0	80.0	1



ayu



wakasagi



golden shiner



red mud roach



natural UV perch



game changer



white ghost



firetiger

PROREX V-MARLEY PELAGIC SHAD LIVE

NEW

SHAD

DAIWA's Pelagic lure from Prorex – now available in super realistic 3D live print coloration. Proven and effective lures for Pike and Zander.

- **Hook: SaqSas treble hook**
- **Sinking behaviour: fast sinking**
- **Presentation techniques: pelagic, vertical**

Equipment:

- Lead-free design



baby zander



perch

Art.-No.	Color	Length cm	Treble Size	Weight g	Content pc.
15227-009	baby zander	21.0	1/0	80.0	1
15227-010	perch	21.0	1/0	80.0	1



PROREX URBAN SHRIMP

SOFT LURE

Realistic crawfish resp. shrimp imitation – especially for perch and zander. The extremely soft rubber is equipped with shrimp flavor and thus provokes vehement bites even during stops. Both claws and legs vibrate even at slow speed. With slot for off-set hook at the back. Ideally suited for drop-shot fishing as well as Cheburaska-, Free- and Carolina-Rigs. Phthalat-free rubber.

Available in 2 sizes and 4 colors.

- Target fishes: perch, zander



Art.-No.	Color	Length cm	Weight g	Content pc.
15152-006	pinky perch	6.0	2.0	8
15152-007	pinky perch	7.2	2.8	8
15152-106	summer craw	6.0	2.0	8
15152-107	summer craw	7.2	2.8	8
15152-206	sundown brown	6.0	2.0	8
15152-207	sundown brown	7.2	2.8	8
15152-306	orange peeler	6.0	2.0	8
15152-307	orange peeler	7.2	2.8	8

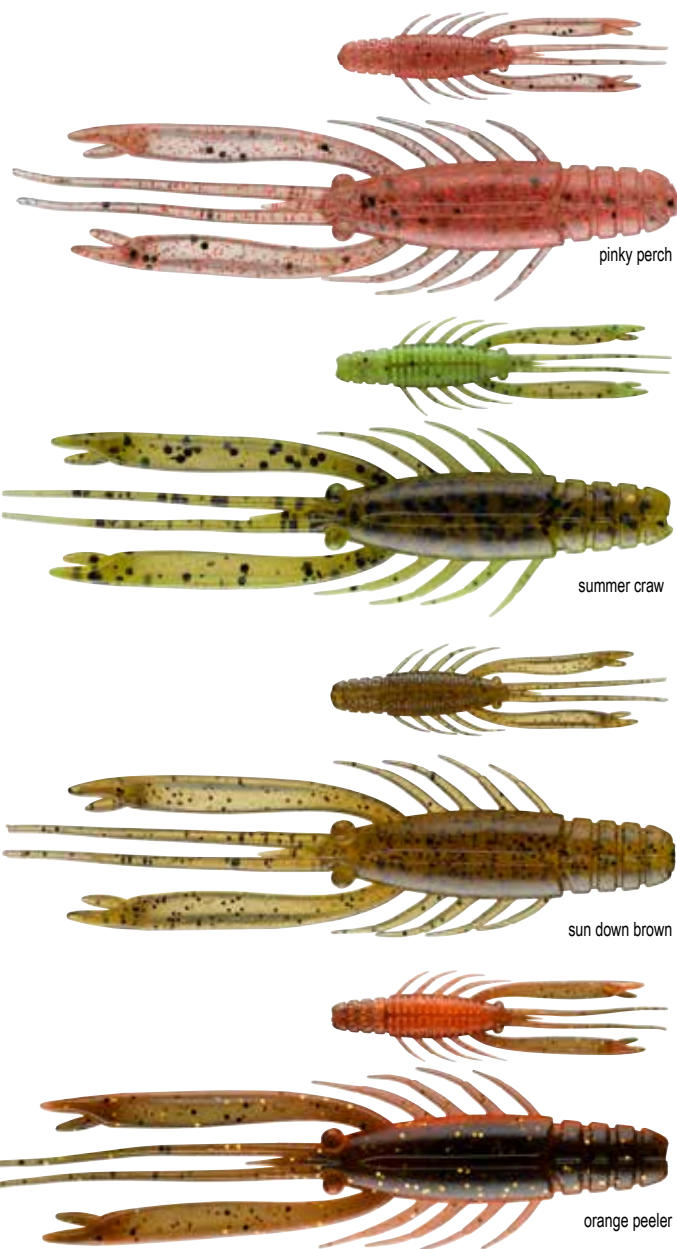

PROREX SWIVELED HEAD ASSIST

STINGER HOOK SYSTEM

The short Swivel Assist hook with split ring has been constructed as head treble and can easily be added to the eyelet of the jighead - ideally suited for all screw-in heads, for pelagic lures etc. With extra sharp SaqSas hooks. Both wire legs can be stuck into the lure, all 3 hook tips are always fully accessible.



Art.-No.	Treble Size	Recommended Lure Length cm	Content pc.
15419-010	1/0	20-30	2
15419-001	1	20-25	2
15419-002	2	18-25	2

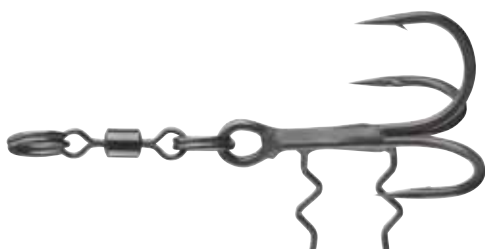

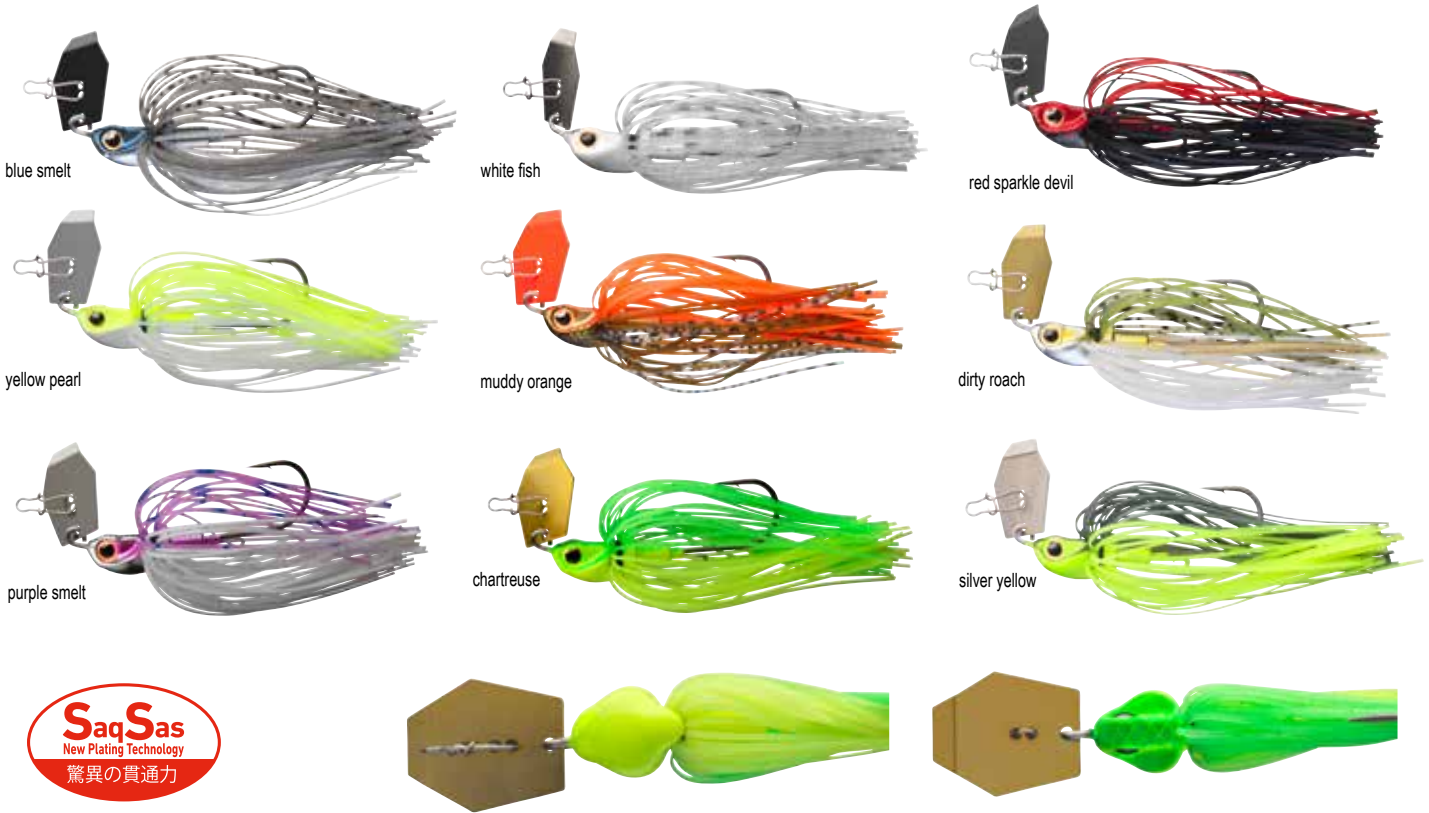

PROREX MICRO BLADED JIG

VIB BAIT

- **Hook:** SaqSas single hook
- **Sinking behaviour:** slow sinking
- **Diving type:** shallow runner
- **Speed:** slow and fast
- **Target fishes:** perch, trout, chub

Further information:

- Can also be fished with small soft plastic lure or twister (not included in delivery)

Equipment:

- Lead-free design

Classical small chatterbait, which is perfectly made for fishing for perch thanks to its size. Due to the tungsten head with a weight of 8g, this lure also runs very steady during fast retrieving. Ideal for usage with 7.5 – 10cm trailer baits. With SaqSas hook and bait holder. Lead-free.

Art.-No.	Color	Hook Size	Weight g	Content pc.
15151-008	blue smelt	1/0	8.0	1
15151-108	whitefish	1/0	8.0	1
15151-208	red sparkle devil	1/0	8.0	1
15151-308	yellow pearl	1/0	8.0	1
15151-408	muddy orange	1/0	8.0	1
15151-508	dirty roach	1/0	8.0	1
15151-608	purple smelt	1/0	8.0	1
15151-708	chartreuse	1/0	8.0	1
15151-808	silver yellow	1/0	8.0	1

PROREX SCREW-IN SHALLOW RIG

STINGER HOOK SYSTEM

Shallow screw-in system made of 70lbs steel wire. Ready-to-fish. With extra strong trebles.

Available in 2 sizes:

M – for lures of ca. 18–25cm

L – for lures of ca. 20–30cm

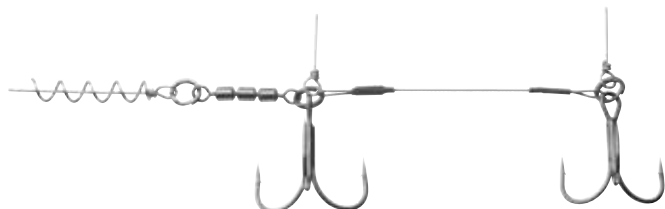

Art.-No.	Treble Size	Strength lb	Weight g	Recommended Lure Length cm	Content pc.
15419-720	2/0+1/0	70	10.0	18-25	1
15419-730	3/0+2/0	70	8.0	20-30	1



PROREX SCREW-IN SWIVEL ASSIST STINGER

STINGER HOOK SYSTEM

Shallow screw-in system with swivels and split rings. Ready-to-fish and instantaneously usable. The system's trick is, to make it harder to remove the hook during the fight with the fish thanks to the swivels. Additionally, this system can exactly be adapted to the lure's size by adding or removing swivels resp. split rings. The swivel's weight additionally stabilizes the lure action. With extra strong trebles.

Available in 2 sizes:

M – for lures of ca. 18–25cm

L – for lures of ca. 20–30cm



Art.-No.	Treble Size	Strength lb	Weight g	Recommended Lure Length cm	Content pc.
15419-620	2/0+1/0	70	12.0	18-25	1
15419-630	3/0+2/0	70	15.0	20-30	1



PROREX STINGER PINS

Ideal for making steel wires and assist-systems. The Stinger Pins with extra small eyelet ensures close contact between wire and plastic lure.



Art.-No.	Length mm	Content pc.
15415-025	25	10

PROREX ASSIST STINGER

Premium Assist-Rigs made of quality steel wire. Due to the tough wire, these rigs can be reused many times without kinking – no need to replace just after a few bites. Depending on the hook size, length of the wire and lure profile, suitable for lures from ~ 13cm – 30cm. The adjustable put over sleeve on the wire eye allows putting it firmly over the jig hook eye without slipping.

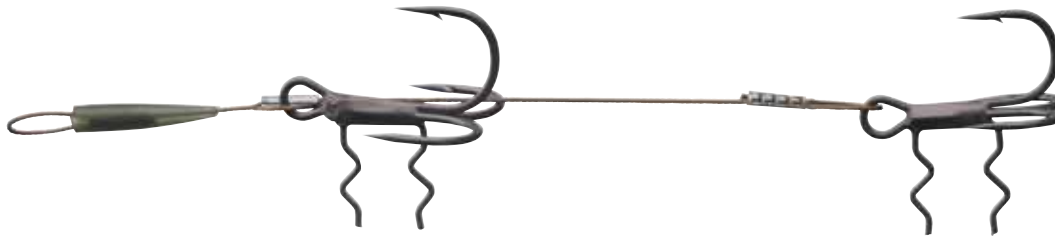

PROREX DOUBLE STINGER

STINGER HOOK SYSTEM



Art.-No.	Length cm	Size	Treble Size	Strength kg	Content pc.
15419-402	5.0	M	2+2	20.0	1
15419-401	7.5	L	1+2	20.0	1



PROREX TAIL STINGER

STINGER HOOK SYSTEM



Art.-No.	Length cm	Size	Treble Size	Strength kg	Content pc.
15419-201	7.0	M	1	20.0	2
15419-202	7.0	M	2	20.0	2
15419-101	10.0	L	1	20.0	2
15419-102	10.0	L	2	20.0	2

PROREX HEAD & TAIL STINGER

STINGER HOOK SYSTEM



Art.-No.	Length cm	Size	Treble Size	Strength kg	Content pc.
15419-310	3.5	S	1/0	20.0	2
15419-301	3.5	S	1	20.0	2
15419-302	3.5	S	2	20.0	2

PROREX ASSIST TREBLE HOOK SAQSAS

TREBLE HOOK



Special Assist hook, with all tips fully exposed. The thorn at the leg is simply stuck into the plastic lure and causes nearly no harm. Extra sharp – with SaqSas coating.



Art.-No.	Hook Size	Content pc.
NEW 15415-006	6	7
15415-004	4	7
15415-002	2	6
15415-001	1	6
15415-010	1/0	5
NEW 15415-020	2/0	5
NEW 15415-030	3/0	5



PROREX SCREW-IN SCREW

SPIRAL SCREW

The Screw-In Spiral, which (2 sizes available) is the basis for the Screw-In system.
Spiral M / 3cm: Suitable for plastic lures of 15-22cm
Spiral L / 5cm: Suitable for plastic lures of 23-30cm



PROREX SCREW-IN SYSTEM

With the Prorex Screw-In System you can rig your soft lures in the way, which is perfectly fitting for fishing in flat waters.

First fix the screw at the head of the soft lure and then mount a double treble system at the screw via a split ring. The trebles can be stuck into the belly of the soft lure. Like this you get a system which can be presented slowly right beyond the surface. Ideal after the spawning season, when the pikes remain in shallow water areas! To change the sinking behaviour, different Prorex Screw-In Weight Balancer weights can be screwed into the belly of the soft lure.

PROREX SCREW-IN WEIGHT BALANCER

SCREW LEAD | FOR SOFT LURES

The Prorex Screw-In Weight Balancer lead can simply be screwed into the belly/head of a soft lure. Depending on position and weight the lure changes its balance and diving depth.

Ideal in combination with the Prorex Screw-In system.



Art.-No.	Weight g	Content pc.
15411-104	4.0	4
15411-106	6.0	4
15411-108	8.0	3
15411-110	10.0	3
15411-112	12.0	3

PROREX SCREW-IN INSERT GLASS RATTLE

PLUG-IN RATTLE

These rattles can be fixed to the soft lure at any position.

The small steel balls in the glass shell produce a slight clattering noise and thus can provoke the bite reflex in certain situations.



Art.-No.	Size	Size mm	Content pc.
15411-203	S	3	6
15411-205	M	5	6

PROREX FLEXI JIG-SYSTEM

Extraordinarily successful system especially designed for ultra-light fishing for perch, zander and chub.



PROREX FLEXI JIG-SYSTEM TG HEAD

JIGHEAD | WITH 3D EYES

The Prorex TG Flexi Jig Heads are made of pure tungsten and thus feature a markedly higher density than jigheads made of lead. Thus, you can fish more subtle and lighter than with conventional jigheads, because there is less resistance from air and current. The threat of hang ups is reduced, while the sensitivity is considerably increased.

Due to the flexible attachment of the hook at the tungsten jighead, this lure features an incomparable tilting action when it reaches the ground, which is especially tempting for zander and perch. Depending on the weight and hook size the tungsten heads are suited for very small softplastic lures of 3-10cm length. The 3D eyes provide an additional attraction under water.

The small heads are also perfectly applicable for fishing in trout ponds!



Art.-No.	Color	Weight g	Content pc.
15412-105	copper	5.0	4
15412-106	copper	6.0	3
15412-107	copper	7.0	3
15412-108	copper	8.0	3
15412-109	copper	9.0	2

Art.-No.	Color	Weight g	Content pc.
15412-205	fluo orange	5.0	4
15412-206	fluo orange	6.0	3
15412-207	fluo orange	7.0	3
15412-208	fluo orange	8.0	3
15412-209	fluo orange	9.0	2

Art.-No.	Color	Weight g	Content pc.
15412-305	fluo-pink	5.0	4
15412-306	fluo-pink	6.0	3
15412-307	fluo-pink	7.0	3
15412-308	fluo-pink	8.0	3
15412-309	fluo-pink	9.0	2



PROREX FLEXI JIG-SYSTEM FN HOOK

SINGLE HOOK

These fine high-quality hooks with chemically sharpened hook tip are the fitting hooks for the Prorex Flexi Jig-System TG heads.

The extra-large eyelet offers much space to allow a free action of the lure at the tungsten head. Thanks to the large eyelet this hooks can also easily be applied at split rings, e.g. when the use of single hooks at spinners is required etc.



Art.-No.	Color	Hook Size	Content pc.
15412-001	black	1	6
15412-002	black	2	6

PROREX SOFT TAIL CONNECTOR

Perfect for attaching trailers at the rear eyelet of jerkbaits, plugs, etc.



Assembly example / hardbait & curly tail

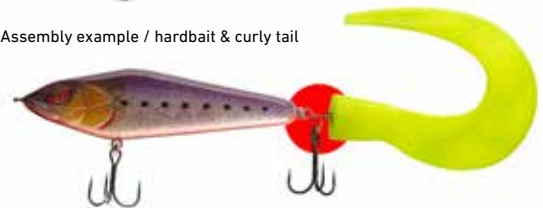

Art.-No.	Color	Length cm	Ø mm	Weight g	Content pc.
15219-000	steel grey	4.0	5.0	25.0	10



PROREX CARBON FOLDING NET

NEW

LANDING NET



Extremely light, big and powerful!

These foldable Prorex boat nets made by DAIWA satisfy immediately by the remarkable low weights and powerful and ultra lightweight 3k woven carbon handle. The net frame is extremely lightweight and strong and reduces weight by simultaneously adding strength thanks to the carbon supported 3K woven surface.

The folding mechanism greatly reduces transport and stowing size and supports easy transport inside the car or on the boat.

The rubberized mesh features 12mm mesh on sides for easy netting during drift and 8mm mesh on bottom for increased fish protection.

The net band provides easy and controlled netting functionality.

The L Version (75x65cm) features a 3k woven carbon handle in 120cm length and an engraved 80cm meter.

The XL version for real lunkers with 85x75cm size features an extra solid aluminium spreader block and an extendable 3k woven carbon handle from 120cm up to 145cm out of the rear handle plus an engraved 80cm meter.

The loop at the EVA rear handle prevents loss during action.

Thanks to it's low weight and strong construction, this Prorex carbon folding boat net solves the handling trouble of many big fish nets on the market causing inconvenient usage being alone on the water.

Material net: Polyester

Art.-No.	Color Handle	Color Net	Length cm	Handle L. cm	Closed L. cm	Size cm	Net Depth cm	Mesh mm	Sect.	Weight g
15810-425	carbon	black	195	120	121	75x65	65	20x20	1	900
15810-430	carbon	black	230	121-145	121	85x75	65	20x20	1	1070

PROREX TOUGH JUNGLE NET XL

NEW

LANDING NET

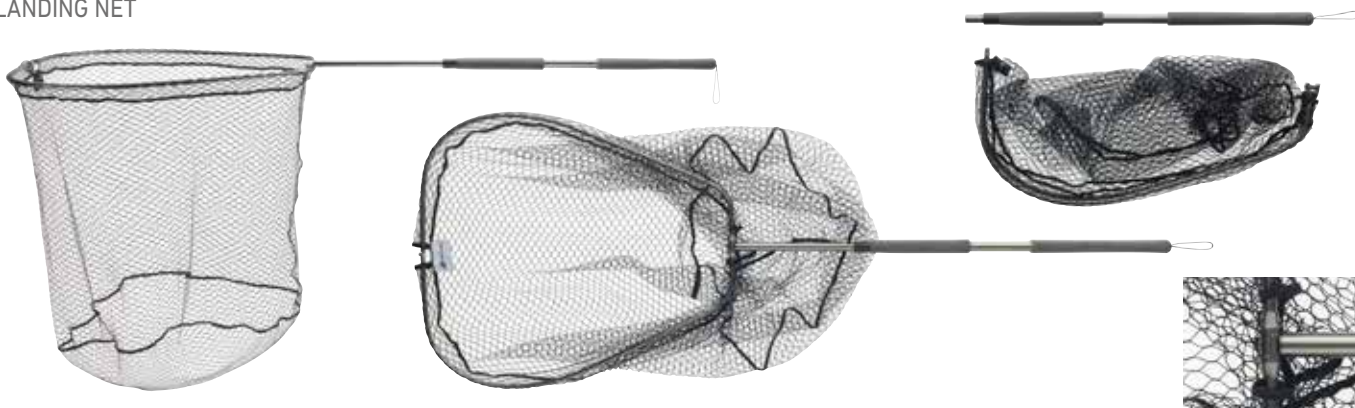

The name says it all – perfectly suited to net fish in weedy areas!

This super strong, foldable boat net with aluminium frame was specially designed for the heavy duties during boat fishing and in weedy areas. The extra strong aluminium frame is firmly screwed into the telescopic handle (85-150cm) by a powerful 11.8x2.2mm screw and provides ultimate power and reliability to cope even with the biggest lunkers delved into weed.

The 20mm rubber mesh is easy to handle inside drift and currents and features an anti-smell function as it will not absorb any water and odours.

The folding mechanism greatly reduces transport and stowing size and supports easy transport inside the car or on the boat

The loop at the EVA rear handle prevents loss during action. Material net: Polyester

Art.-No.	Color Handle	Color Net	Length cm	Handle L. cm	Closed L. cm	Size cm	Net Depth cm	Mesh mm	Sect.	Weight g
15810-440	grey	black	220	85-150	85	80x70	65	20x20	2	1070

PROREX SHORT TRACK BOAT NET

NEW

BOAT NET

This compact and powerful DAIWA landing net is the perfect choice once fishing from smaller boats with limited space and for bank fishing. The strong net head with 70x60cm size features a 60cm extra deep net and gives space even for huge fish. The strong 80cm aluminium handle can be fully passed through the spreader block for easy transport and is easy to fix by simply turning the handle. The rubber net features 10mm mesh size for maximum fish care and will not absorb odours and water. Material net: Polyester

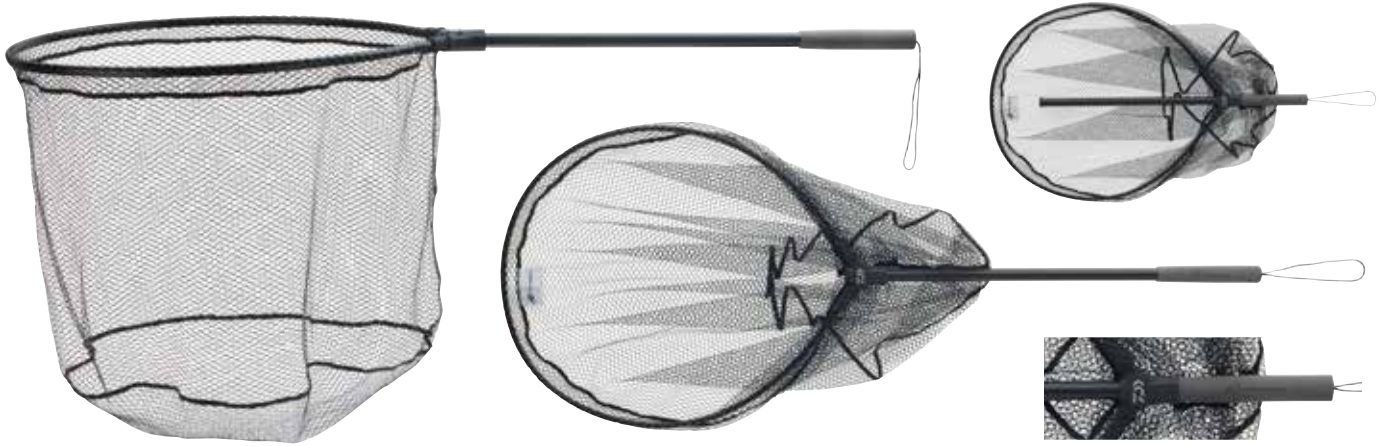

Art.-No.	Color Handle	Color Net	Length cm	Handle L. cm	Closed L. cm	Size cm	Net Depth cm	Mesh mm	Weight g
15810-470	black	black	150	80	82	70x60	60	10x10	840

PROREX FAST FOLD STALKER NET

NEW

LANDING NET

This fast fold landing net with solid frame and aluminium spreader block is the perfect choice for mobile anglers. The landing net head can be easily and instantly folded up just by one short shake of your arm. The telescopic aluminium handle can be adjusted between 80-140cm length. The 12mm rubberized mesh features an anti-smell function and will not absorb water. Available in two sizes: 60x50cm and 70x60cm. Material net: Polyester



Art.-No.	Color Handle	Color Net	Length cm	Handle L. cm	Closed L. cm	Size	Size cm	Net Depth cm	Mesh mm	Sect.	Weight g
15810-450	black	black	205	80-140	82	M	60x50	40	12x12	1	570
15810-460	black	black	215	80-140	82	L	70x60	50	12x12	1	670

PROREX FAST FLOW ECO BOAT NET

NEW

BOAT NET



Economic prized XL boat landing net with rubber mesh!

Strong and solid Prorex boat net made by DAIWA featuring a powerful aluminium handle and rubber mesh. Thanks to the size of 75x65cm, this net will easily handle even huge fish over 1m size. The large rubber mesh will reduce drag in the water and make netting easier once drift and current will occur. Does not absorb odours and water.

Material net: Polyester

Art.-No.	Color Handle	Color Net	Length cm	Handle L. cm	Closed L. cm	Size cm	Net Depth cm	Mesh mm	Sect.	Weight g
15810-410	black	black	185	110	110	75x65	65	12x12	1	850

PROREX WADING NET

WITH TELESCOPIC HANDLE SECTION

Premium wading landing net with extra soft, lightweight net with silicone coating. The net's size of 55x45x40cm offers enough space even for biggest fish.

The extremely soft silicone coating is highly protective for the fish's mucosa, doesn't absorb moisture and odor and can be cleaned easily – additionally the silicone coated net is much more lightweight than usual nets with rubber coating!

The Prorex landing net convinces by several well-considered details. Due to the special holder at the handle, it can be fixed to the wading belt or to the wader at the back and thus doesn't interfere with casting and wading. With the elastic fixation strap and the attached snap, the loss of the landing net can additionally be prevented. The handle section can be extended telescopically – ideal when you are fishing with somewhat longer rods for sea trout.

Material net: Polyester

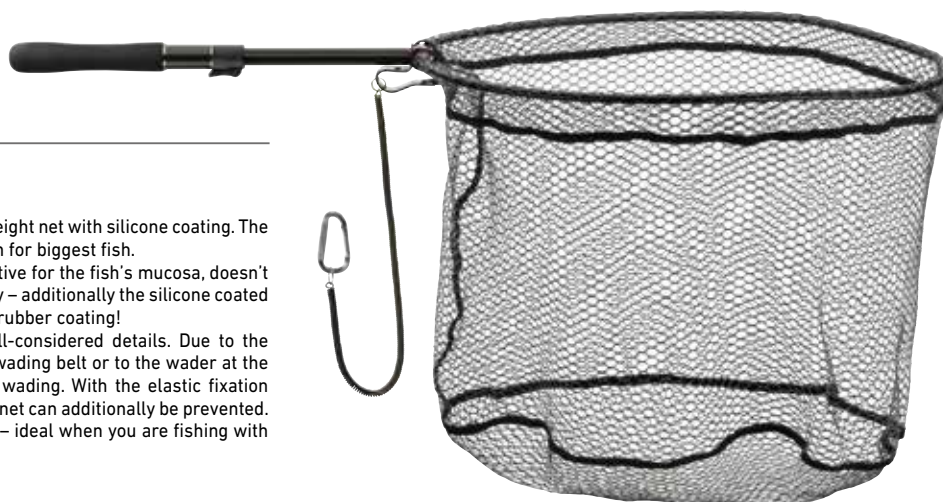

Art.-No.	Length cm	Handle L. cm	Closed L. cm	Size cm	Net Depth cm
15809-745	98	Tele 25-43	82	55x45	40





PROREX STALKER CARBON TELE HANDLE MULTI ADJUST

NEW

LANDING NET HANDLE

This lightweight but strong quality carbon handle features a 3k woven surface and is a real multi-talent being able to be twist less adjusted and fixed to each individual segment. The screw nut provides individual threads for each segment. Thanks to the short length, this Prorex power carbon handle is easy to transport and stow. With English thread.

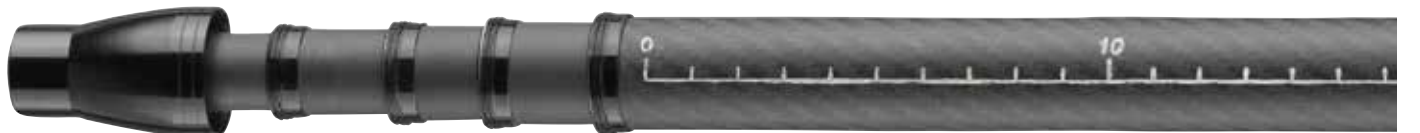

Art.-No.	Color Handle	Length cm	Handle L. cm	Closed L. cm	Sect.	Weight g
15810-250	carbon	250	61-250	61	5	200



PROREX HYBRID KNOTABLE WIRE

NEW

LEADER MATERIAL | KNOTABLE

The sensation wire from Japan! Thanks to the thin diameter and coating properties of the wire, the Prorex Hybrid Wire feels like monofilament and can be knotted easily just as Nylon lines. Best strength is hereby achieved by using the simple Palomar-Knot! The very thin, smooth and flexible wire is especially suitable for small and smallest lures as the action is not affected by this wire. Perfectly suitable for UL fishing on Perch with tiny lures once Pike's are to be expected as well. The brown camouflage surface reduces reflections and reduces contrast under water. Made in Japan.

Art.-No.	Color	Rig Length m	Ø mm	Strength kg
17930-029	brown	6.0	0.226	2.9
17930-037	brown	6.0	0.248	3.7
17930-044	brown	6.0	0.275	4.4
17930-054	brown	6.0	0.300	5.4



PROREX SCREW-IN HEADS LEAD FREE

Classic Screw-in Jig Head. The additional eyelet can be used to attach an additional stinger hook. Available in two shapes – classic round shaped and football shape. The football shape provides slightly stronger side-to-side flanking action. Lead Free.

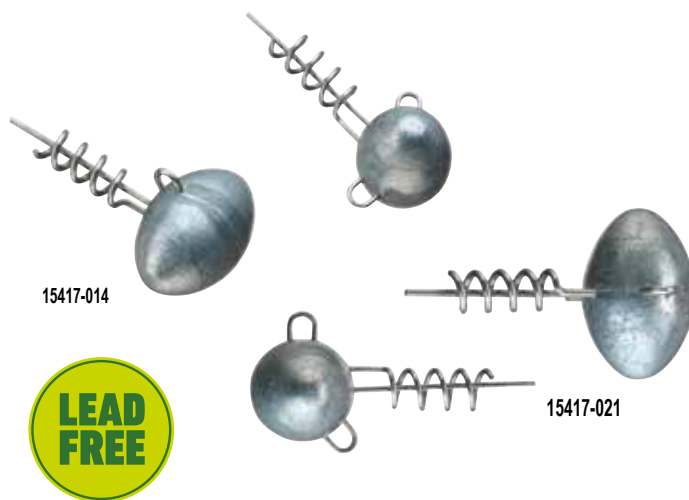
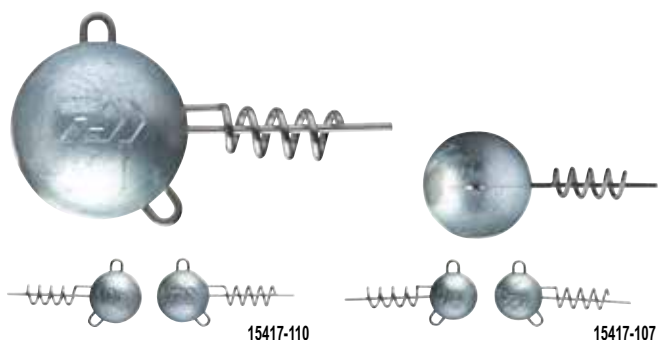

PROREX ROUND SCREW-IN HEADS LEAD FREE

NEW

JIGHEAD | ROUND

Art.-No.	Weight g	Content pc.
15417-107	7.0	3
15417-110	10.0	3
15417-114	14.0	2
15417-121	21.0	2
15417-128	28.0	2

PROREX FOOTBALL SCREW-IN HEADS LEAD FREE

NEW

JIGHEAD

Art.-No.	Weight g	Content pc.
15417-007	7.0	3
15417-010	10.0	3
15417-014	14.0	2
15417-021	21.0	2

PROREX TITANIUM STEEL WIRE

Titanium material is hardly susceptible for kinkings, which is a great advantage. Thus it is distinctly more durable than usual 1x7 or 7x7 steel wires. Additionally titanium leaders provoke less tanglings during the cast and at active retrieving!
Ideal for twitching and jerkbaiting with plugs!

- Very flexible
- For active lure presentation

PROREX TITANIUM WIRE LEADER

WITH SWIVEL AND SNAP

Art.-No.	Rig Length cm	Strength kg	Content pc.
17925-712	20.0	12.0	2
17925-718	20.0	18.0	2
17925-725	20.0	25.0	2
17925-812	30.0	12.0	2
17925-818	30.0	18.0	2
17925-825	30.0	25.0	2

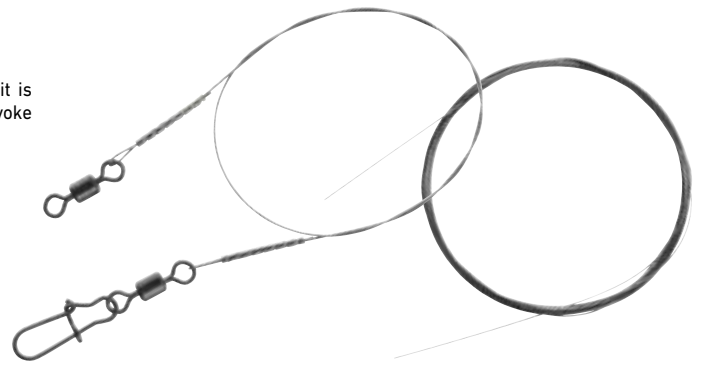

PROREX TITANIUM WIRE SPOOL

3M SPOOL

Art.-No.	Length m	Strength kg	Content pc.
17925-912	3.0	12.0	1
17925-918	3.0	18.0	1
17925-925	3.0	25.0	1

PROREX FLUOROCARBON LEADER

WITH SWIVEL AND SNAP

Strong and abrasion resistant Fluorocarbon leader. Equipped with extra strong Prorex swivel and snap, this leader is highly recommended for the use at clear waters when you are fishing with large lures. The high linear strength easily withstands the bite of a pike.

Art.-No.	Rig Length cm	Strength kg	Content pc.
17925-622	30.0	22.0	1
17925-631	30.0	31.0	1
17925-636	30.0	36.0	1



PROREX SNAP

LURE SNAP

The Prorex snaps are made of extra thick and strong „Stainless Steel“ and feature an extraordinarily high linear strength. These snaps don't bend up even under highest strains and offer optimal safety. Due to the dull black surface, reflections and thus frightening of fish under water is reduced.

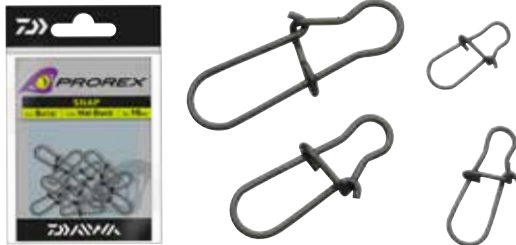

Art.-No.	Color	Swivel Size	Strength kg	Content pc.
15408-000	matt black	16	9.0	10
15408-001	matt black	12	18.0	10
15408-002	matt black	6	24.0	10
15408-004	matt black	4	32.0	10

PROREX SWIVEL

SWIVEL

The Prorex swivels with snaps are made out of extra thick and strong „Stainless Steel“ and feature an extraordinarily high linear strength. These snaps don't bend up even under highest strains and offer optimal safety. Due to the dull black surface, reflections and thus frightening of fish under water is reduced.

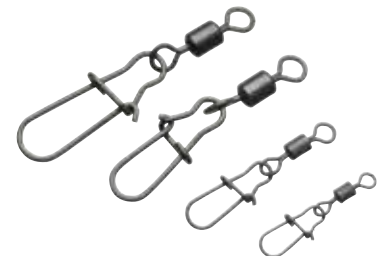

Art.-No.	Color	Swivel Size	Strength kg	Content pc.
15408-100	matt black	16/8	9.0	10
15408-101	matt black	12/6	18.0	10
15408-102	matt black	6/2	24.0	10
15408-104	matt black	4/2	32.0	10



PROREX SINGLE CRIMPS

CRIMPING SLEEVES | SINGLE

Premium, thick-walled and at the same time soft crimps for rigging wire leaders, hard-mono leaders etc. Due to the soft brass material the leader material is spared at crimping.



Art.-No.	Ø mm	Content pc.
15408-200	0.84	50
15408-201	1.04	50
15408-202	1.40	50
15408-204	1.80	50

PROREX DOUBLE CRIMPS

CRIMPING SLEEVES | DOUBLE

The double crimps are especially suitable for the rigging of thick steel wires and for hardmono or fluorocarbon leaders.



Art.-No.	Ø mm	Content pc.
15408-300	1.00	30
15408-301	1.30	30
15408-302	1.90	30

PROREX „FISH-LIP“ GRIP

LANDING PLIERS | WITH INTEGRATED SCALE



The Prorex landing pliers are perfectly suitable for landing zanders, perch and pikes. Simply place it into the underjaw, close the pliers and lift out the fish. The ends of the jaws are rounded and spherically shaped to prevent injuring of the fish at lifting. A spring scale up to 28lbs/13kg is integrated into the pliers. Due to the aluminum construction, this landing pliers are very lightweight and can be carried effortlessly in every small fishing bag.

Art.-No.	Length cm	Content pc.
15409-020	29.0	1



PROREX SIDE CUTTER

Premium, small cutter for steel wires and thick monofilament lines. The Teflon coating reduces the danger of corrosion.

The end of both handles are marked with self-luminous material to facilitate finding of the pliers in the dark.

Art.-No.	Length cm	Content pc.
15409-025	14.0	1



PROREX CRIMPING PLIERS

Premium crimping pliers with two sections for differently sized crimps. The five pressure points at the jaws guarantee an optimal crimping and prevent damaging of the steel wire at the crimp edge.

The end of both handles are marked with self-luminous material to facilitate finding of the pliers in the dark.

Art.-No.	Length cm	Content pc.
15409-005	14.0	1



PROREX „PISTOL“ DISGORGER

This disgorger pliers are perfectly made for loosening hooks and lures, which have been swallowed deeply. Due to the applied angle you can release the hook easily and safely. The jaws with grooves optimally grab also thin hooks and facilitate fixing and releasing.

The Teflon coating reduces the danger of corrosion.

The end of both handles are marked with self-luminous material to facilitate finding of the pliers in the dark.

Art.-No.	Length cm	Content pc.
15409-000	24.0	1



PROREX MULTIFUNCTION PLIERS

The Prorex multifunction pliers is ideal for opening split rings of 5mm to 12mm. Additionally this pliers offer the possibility to cut steel and monofilament lines via the cutting edge and thus predestinate this tool for the manufacturing of steel wire leaders. The jaws are equipped with extra pressure points like at conventional crimping pliers. The Teflon coating reduces the danger of corrosion.

Equipped with ergonomic, anti-slip handles.

Art.-No.	Length cm	Content pc.
15409-030	23.0	1



PROREX „LONGNOSE“ PLIERS

STRAIGHT DESIGN

Extra long and very durable disgorger pliers made of stainless steel. Ideal to loosen deeply swallowed lures and hooks.

The Teflon coating reduces the danger of corrosion.

Equipped with ergonomic, anti-slip handles.

Art.-No.	Length cm	Content pc.
15409-010	28.0	1



PROREX „LONGNOSE“ PLIERS

CURVED DESIGN

Extra long and very durable disgorger pliers made of stainless steel with curved jaws. Ideal to loosen deeply swallowed lures and hooks.

The Teflon coating reduces the danger of corrosion.

Equipped with ergonomic, anti-slip handles.

Art.-No.	Length cm	Content pc.
15409-015	28.0	1

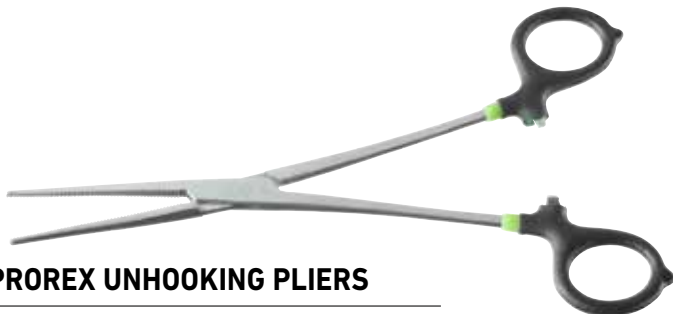

PROREX UNHOOKING PLIERS

STRAIGHT DESIGN

Premium unhooking pliers for loosening hooks. Due to the fixation mechanism you can securely grip deeply swallowed hooks and then pull gently into different directions to detach the hook.

Art.-No.	Length cm	Version	Content pc.
15409-035	20.0	straight	1



PROREX UNHOOKING PLIERS

CURVED DESIGN

Premium unhooking pliers for releasing hooks. Due to the fixing mechanism you can fix deeply swallowed hooks and then push in different ways to release the hook gently.

Art.-No.	Length cm	Version	Content pc.
15409-040	20.0	curved	1



PROREX D-BOX TACKLE BAG

LURE / TACKLE BAG | L-SIZE

Within this modern tackle bag, you can store nearly all of your lures and other tackle, which is needed for fishing. The water-repellent material is very durable and can easily be cleaned. The rubberized bottom prevents the intrusion of water. The lower compartment is equipped with 4 big DAIWA D-boxes and offers enough space for big tackle boxes or reels, spools, foods, drinks, rainwear etc. Within the bit front pocket, you can store long pliers, documents and others. 4 additional side pockets offer space for small boxes, leader bags etc. The zipper is made of ABS material and extremely durable without corroding.

Equipment:

- 2x D-Box LR #18312-005
- 1x D-Box LD #18312-010
- 1x D-Box LS #18312-000

Material: Bag polyester; Bottom PVC



Art.-No.	Size	Size cm
15808-050	L	45x42x25



PROREX D-BOX TACKLE BAG

LURE / TACKLE BAG | M-SIZE

Small, compact tackle bag incl. 3 DAIWA D-boxes in medium size. Ideal for a short fishing trip, when not that much tackle is needed or for many small tackle and lures. The D-boxes can be stored horizontally or vertically within the bag. If needed, 2-3 additional boxes can be stored within the main compartment. Within the inner part of the lid, you find a big pocket for documents, handy, keys etc. The big front pocket is perfectly fitting for the smaller DAIWA D-boxes. 2 extra big side pockets offer space for many small tackle, documents etc. The water-repellent material is very durable and can easily be cleaned. The rubberized bottom prevents the intrusion of water. The zippers are made of ABS material and extremely durable without corroding.

Equipment:

- 1x D-Box MS #18311-000
- 1x D-Box MD #18311-010
- 1x D-Box MR #18311-005

Material: Bag polyester; Bottom PVC



Art.-No.	Size	Size cm
15808-020	M	40x25x22



PROREX SOFTBAIT BINDER

LURE / TACKLE BAG

This small space-miracle can host up to 12 different zip-bags for plastic lures. Ideally suited when flavored lures should remain within the bag. This organizer solves the problem of common zip bags not fitting into plastic boxes and stores them to be prepared for any target fish or fishing technique. The organizer can be attached to other tackle bags via carabiner and loop and exactly fits to the front pocket of the Prorex Tackle Bags size M. The water-repellent material is extremely durable without corroding.

Material: polyester



Art.-No.	Size cm
15809-520	25x17



PROREX TACKLE CONTAINER

XL-SIZE

This very robust but lightweight tackle container made of hard EVA offers tremendous space for big tackle boxes, accessories, clothes, boots etc. Furthermore, the container offers eyelets at the upper edge for mounting up to 16 lures – thus loose lures or trebles can be stored in a convenient and secure way during transportation or at the boat.

The extra strong zipper with XL teeth ensures a long lifespan.

Due to the hard cover, the content is perfectly protected against damage from the outside. Additionally the bag is totally waterproof – thus your tackle is protected against infiltrating rain and water from the bottom.

The broad shoulder strap offers great carrying comfort and is adjustable regarding its length.

Material: Bag EVA

Product delivered without content.



Art.-No.	Size	Size cm
15809-500	XL	46x35x30



PROREX LURE STORAGE BAG

XL-SIZE

This premium lure bag made of solid and robust EVA material offers much space for XL lures, accessories and pliers.

The upper compartment can be removed completely, within the main compartment below one big XL tackle box up to 10cm as well as further small tackle can be stored.

The upper compartment is equipped with a thick EVA board to mount up to 16 fully rigged lures up to 28cm – thus you securely can prepare your fishing equipment ready-to-use. This compartment contains two straps with hook and loop fastener at the end, allowing even the fixation at the railing of the boat – the needed lures are thus ready to hand. A net pocket within the lid offers space for documents, keys etc. Due to the entirely waterproof material, this bag provides optimal protection against rain and splashing water.

Equipped with broad shoulder strap for optimal carrying comfort.

Material: Bag EVA



Product delivered without content.

Art.-No.	Size	Size cm
15809-505	XL	46x30x15.5



PROREX ROVING BAG

This premium and highly robust shoulder bag with hard outer shell offers numerous features, which facilitate its application at fishing.

The Roving shoulder bag is designed in a way that guarantees unimpeded movements during fishing – when tackle is needed, the bag can be swung around and single compartments can be opened easily without the necessity of laying down the bag. The bag contains two main compartments for tackle and lures. One main compartment is equipped with EVA board to store spoons, plugs, softplastic lures with jig heads etc. which are thus ready-to-use. The second main compartment is equipped with a tackle box for diverse small parts and lures. The Box is connected to the bag via hook and loop fastener, which prevents unwanted loss of the box during fishing. The shoulder strap is completed by a big superimposed pocket for documents etc., a separate handy pocket with hook and loop fastener and another small superimposed pocket for keys etc.

With the Prorex Roving shoulder bag you gain a real "space miracle", which is perfectly fitting for street fishing and stalking fishing!

The hard cover with woven-carbon fiber design offers perfect protection from damages.

Equipped with wide, padded shoulder strap which ensures an optimal carrying comfort even if the bag is fully loaded.

Material: Bag polypropylene; Carry strap polyurethane



Product delivered without content.

Art.-No.	Size cm
15809-510	32x23x9.5

PROREX ROVING RUCKSACK

Light but durable rucksack with four big tackle boxes in the main compartment and two small tackle boxes at the side.

Due to the special construction of the main compartment, single tackle boxes can be removed without the upper ones sliding down. The separations are fixed with hook and loop fastener and can be removed easily, allowing the use also of bigger boxes. In the big upper compartment many accessories like pliers, reels etc. can be stored. The superimposed hardcover case for glasses at the front is especially fitting for pole glasses. The back is thickly padded to carry the rucksack comfortably over longer distances even when fully loaded. With rubberized bottom and anti-slip pads to prevent slipping and the intrusion of water.

Material: Bag polyester



Art.-No.	Size cm
15810-900	40x25x45



PROREX SHOULDER BAG

This big shoulder bag offers plenty space for numerous small pieces, documents, etc. Two big tackle boxes of the common size 36x22.5x5.5cm are included for the transportation and storage of soft plastic lures. Both front pockets additionally offer much space for the secure transportation of smaller lure boxes with supplies, jig hooks etc.

All of the bag's outer material is water repellent and restrains short showers without soaking. The rubberized bottom prevents the intrusion of moisture from below.

Equipped with padded shoulder strap which ensures an optimal carrying comfort even if the bag is fully loaded.

Material: Outer material polyurethane, PVC coated; Inner material polyester

Art.-No.	Size cm
15809-400	39x25x26

PROREX LURE BAG

M-SIZE

This shoulder bag for spin fishing offers much space for the storage of lures and supplies.

The bag is delivered including 3 big tackle boxes of the common size 36x33.5x5.5cm. Both front pockets additionally offer much space for the transportation of smaller lure boxes for jig hooks, swivels etc.

All of the bag's outer material is water repellent and restrains short showers without soaking. The rubberized bottom prevents the intrusion of moisture from below.

Equipped with padded shoulder strap which ensures an optimal carrying comfort even if the bag is fully loaded.

Material: Outer material polyurethane, PVC coated; Inner material polyester

Art.-No.	Size	Size cm
15809-410	M	38x25x24

TOPLoader



PROREX LURE BAG

TOPLOADER | XL-SIZE

This extra big carrying bag offers enormous space for the storage of lures and supplies.

The bag is delivered including 2 big tackle boxes of 36x22.5x5.5cm and one extra tall soft plastic lure box of 36x22.5x8.5cm. The tall box can store extra big soft plastic lures which do not fit into flat lure boxes. Both front pockets and both side pockets additionally offer much space for the secure transportation of smaller lure boxes with supplies, jig hooks etc. The big main compartment above the boxes offers storage space for big pieces and can be separated in differently sized compartment via velcro dividers as required.

All of the bag's outer material is water repellent and restrains short showers without soaking. The rubberized bottom prevents the intrusion of moisture from below.

Equipped with padded shoulder strap which ensures an optimal carrying comfort even if the bag is fully loaded.

Material: Outer material polyurethane, PVC coated; Inner material polyester

Art.-No.	Size	Size cm
15809-420	XL	46x34x27



TOPLoader

PROREX LURE BAG

TOPLOADER | XXL-SIZE

The perfect bag for fishing from the boat!
 If you regularly go fishing for large specimen with big lures like plugs, swimbaits etc., you are well-advised with this Prorex lure bag XXL, since it offers enormous space also for XL-lures. The bag is delivered with 3 big and tall lure boxes of 36x22.5x8.5cm – ideal for large lures like jerkbaits, swimbaits etc., which do not fit into regular flat boxes. The big front pocket and both side pockets offer much space for smaller boxes and supplies.
 The big main compartment above the boxes offers storage space for big pieces and can be separated in differently sized compartment via velcro dividers as required. All of the bag's outer material is water repellent and restrains short showers without soaking.

Equipped with padded shoulder strap which ensures an optimal carrying comfort even if the bag is fully loaded.

Material: Outer material polyurethane, PVC coated; Inner material polyester

Art.-No.	Size	Size cm
15809-425	XXL	46x35x33

PROREX TACKLE BAG

This affordable bags within our DAIWA Prorex range offers enormous space for lures and small pieces for a very good price-performance ratio.
 The bottom of the Prorex tackle bags is rubberized to prevent the intrusion of moisture. Additionally, anti-slip pads avoid slipping on wet ground – ideal at the boat.

Equipped with padded shoulder strap which ensures comfortable carrying also when fully loaded.



PROREX TACKLE BAG

L-SIZE

The big main compartment of the large Prorex tackle bag contains 3 big lure boxes with space for plastic lures, plugs, jigheads etc. An additional small plastic box is placed in one of two superimposed pockets at the front and perfectly stores small things like swivel etc. Both side pockets offer space for additional accessories, phone etc.

Material: Outer material nylon; Inner material polyester

Art.-No.	Size	Size cm
15810-500	L	38x18x24

PROREX TACKLE BAG

M-SIZE

The main compartment of the medium sized Prorex tackle bag contains 2 big lure boxes with space for plastic lures, plugs, jigheads etc. The big front pocket and both side pockets offer much space for documents and small items.

Material: Outer material nylon; Inner material polyester

Art.-No.	Size	Size cm
15810-600	M	38x14x24



PROREX 1 ROD BAG

ROD HOLDALL | FOR 1 MOUNTED ROD

Thickly padded holdall for one made-up rod. The bottom is rubberized to prevent the intrusion of water and moisture.

Equipped with padded shoulder strap and carrying handle.

Material: Bag polyester

Art.-No.	Length cm	Version
15812-240	128	for 1 rod up to 2.40m
15812-270	145	for 1 rod up to 2.70m
15812-300	157	for 1 rod up to 3.00m



PROREX 2 ROD BAG

ROD HOLDALL | FOR 2 MOUNTED RODS

Thickly padded transportation tube for two made-up rods. The thick padding ensures an optimal protection of the rods and reels.

The bottom is rubberized to prevent the intrusion of water and moisture. Equipped with padded shoulder strap and carrying handle.

Material: Bag polyester

Art.-No.	Length cm	Version
15813-240	128	for 2 rods up to 2.40m
15813-270	145	for 2 rods up to 2.70m
15813-300	157	for 2 rods up to 3.00m



PROREX 1 ROD BAG

NEOPRENE ROD HOLDALL | FOR 1 MOUNTED ROD

This affordable neoprene holdall ensures optimal protection during transportation and the rod can be transported with mounted reel. The spool area is made of mesh material to prevent corrosion during longer storage since it allows remaining moisture to evaporate.

Material: Bag 90% neoprene, 10% nylon;
Mesh: Polyester

Art.-No.	Size cm	Version
15810-210	115x8	for 1 rod up to 2.10m
15810-240	127x8	for 1 rod up to 2.40m
15810-270	154x8	for 1 rod up to 2.70m



PROREX CONVERTER STALKER ROD & HIP BAG

SPECIAL ROD HOLDALL | FOR 1 MOUNTED ROD

With this transformation miracle, you can simply transform your rod protection bag into a hip bag. Ideal if you need to go over great distances at spin fishing with only little tackle.

Both superimposed pockets with 20x16cm can store lure boxes up to 19.5x15.5cm. The additional superimposed pocket at the front with 12x16cm is perfectly suited for documents, keys, etc. At the front you additionally find a plier holder as well as a bottle holder, which can be fixed via carabiner. Two big, additional carabiners at the side offer the possibility for mounting further accessories. The hip bag can quickly and easily be adjusted to the body via hook and loop fastener and is very comfortable to carry.

Material: Bag polyester

Art.-No.	Length cm	Version
15814-240	128	for 1 rod up to 2.40m
15814-270	145	for 1 rod up to 2.70m
15814-300	157	for 1 rod up to 3.00m



PROREX HOODIE

BLACK

Stylish extra-thick and very cosy hoodie with two side pockets with Prorex print at the front and the back.

Material: 80% cotton, 20% polyester



Art.-No.	Color	Size
18205-520	black	M
18205-530	black	L
18205-540	black	XL
18205-550	black	2XL





N'ZON PROGRAM 2025







Feeder fishing experiences a boom in Europe right now. More and more anglers commit themselves to this successful and variable fishing style. DAIWA has a long record as innovator of new, innovative technologies as well as of premium fishing gear.

The N'Zon range unites the very best of the DAIWA technology world, like the LT reel technology, distance control line clip, HVF Nanoplus carbon fiber technology with the know-how of our experienced product designers for feeder fishing from Europe.

Our goal is making fishing a success and great fun for you, since we aim to ensure you reach your aspirations – N'Zon – hit your target.

n'ZON

HIT YOUR TARGET





24 N'ZON PLUS LT

NEW

FEEDER REEL

AIRDRIVE
DESIGN

ZAION V

QD
Quick Drag

Extremely precise and resilient for feeder fishing!

The 24 N'Zon Plus models are also featuring the latest Airdrive technology. By the combination of the Airdrive Rotor made by Zaion V material and an ultra-light LC ABS Airdrive Spool, the total weight is reduced, and the centre of gravity is shifted to the rear part of the reel resulting into better balance and sensitivity. In addition, casting accuracy and distance are improved. The Airdrive Bail was completely redesigned to eliminate the risk of line tangles on the bail arm. The aluminium body firmly holds the Digigear II torsion resistant inside the body and supports a perfect power transmission – perfect for retrieving heavy cages from far distances. The QD drag can be easily and fast adjusted for any critical situation. An outstanding reel for method fishing!

- AIRDRIVE Design
- Aluminum reel body
- 5 ball bearings (incl. 1 CRBB®)
- ZAION V® AIRDRIVE ROTOR®
- DIGIGEAR® II
- QD® Quick drag system
- AIRDRIVE ABS® longcast spool
- HIP® line clip
- AIRDRIVE BAIL
- Twist Buster® III line roller
- One-touch aluminum fast snap handle



Art.-No.	Size	BB CRBB	BB total	Capacity ml/mm	Ratio	Retrieval cm	Drag kg	Weight g
10317-500	5000S-CP	1	5	150/0.28	4.7:1	79	12.0	290
10317-600	6000SS-CP	1	5	150/0.28	4.9:1	86	12.0	385



20 N'ZON LT

MATCH & FEEDER REEL

LT LIGHT TOUGH

TOUGH DIGIGEAR

AIR ROTOR

ATD
AUTOMATIC DRAG SYSTEM

Distance reel with outstanding price-performance ratio and silky-smooth running!

The N'Zon LT from DAIWA is of outstanding quality and has been particularly designed for the ambitious application at match and feeder fishing. The Tough Digigear cares for an optimal performance and allows lifting of heavy cage feeders to the surface very quickly also over long distances due to its huge power. Despite the low transmission rate the line retraction is significant because of the use of an extra-large spool, which is an additional advantage regarding gear power and lifespan. The ATD drag starts to work instantly without any starting resistance – perfect when using thin lines and in critical situations during the fight with the fish.

The longcast ABS aluminum spool features very low friction during the cast and enhances your casting distance.



- LT (Light & Tough)
- 4 ball bearings
- AIR ROTOR®
- DIGIGEAR® II
- Infinite Anti-Reverse®
- ATD™ drag system
- Cross Wrap® system
- ABS® aluminum longcast spool
- HIP® line clip
- AIR BAIL®
- Twist Buster® II line roller
- One-touch aluminum fast snap handle



TOUGH DIGIGEAR



Art.-No.	Size	BB total	Capacity m/mm	Ratio	Retrieval cm	Drag kg	Weight g
10312-500	5000S-CP	4	150/0.28	4.7:1	79	12.0	290
10312-600	6000SS-P	4	150/0.28	4.9:1	86	12.0	390



24 N'ZON PLUS DISTANCE 25 QD

NEW

FEEDER REEL | WITH 25MM SPOOL STROKE

QD **ZAION** DIGIGEAR
AIR ROTOR

The long cast model in the N'Zon range with 25mm spool stroke!

The 24 N'Zon Plus Distance version with 25mm stroke offers extreme casting distances and incredible retrieving power. Thanks to the low gear ratio of 4.7:1, heavy loads can easily be retrieved from long distances. The reel body made of Zaion material ensures a permanently torque resistant location of the inner gear unit. The long stroke of 25mm in combination with the conical aluminium long cast spool provides extreme casting distances. The special spool lip additionally reduces friction during casting. The HIP line clip well protects the line. With One-Touch aluminium folding handle and QD drag with carbon washers.

- ZAION® reel body
- Aluminum body cover
- 4 ball bearings (incl. 1 CRBB®)
- ZAION V® ROTOR
- DIGIGEAR® II
- QD® Quick drag system
- Carbon drag discs
- Cross Wrap® system
- ABS® aluminum longcast spool
- HIP® line clip
- AIR BAIL®
- Machined aluminum handle

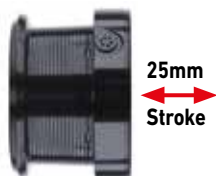

Art.-No.	Size	BB CRBB	BB total	Capacity m/mm	Ratio	Retrieval cm	Drag kg	Weight g
10133-425	25QD	1	4	150/0.28	4.7:1	96	12.0	450



20 N'ZON DISTANCE 25

FEEDER REEL | WITH 25MM SPOOL STROKE



Power reel for long distance feeder fishing!

The N'Zon Distance 25 from the DAIWA feeder range perfectly comes into play at fishing over medium and long distances. The ideal weapon for attaining long casting distances with heavy feeder rigs. With the N'Zon 25 the DAIWA engineers designed a premium fishing reel that offers large power reserves at an exemplary price-performance ratio.

- 1 ball bearing
- Infinite Anti-Reverse®
- 25mm spool stroke
- Conical aluminum longcast spool
- Twist Buster® II line roller
- Longlife bail spring
- CNC-machined aluminum handle

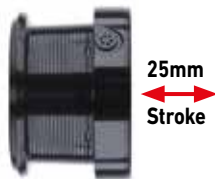

Art.-No.	Size	BB total	Capacity m/mm	Ratio	Retrieval cm	Drag kg	Weight g
10133-325	25	1	150/0.28	4.6:1	92	9.0	530



N'ZON DISTANCE SPECIAL FEEDER

FEEDER ROD | CW -90G | -120G | -150G | -180G

The N'Zon Distance Special Feeder rods convince by their fast actions, premium processing, slim blanks and an optimal balance. By using exclusive DAIWA technologies, like HVF nanoplus material for the blank, X45 blank design and V-Joint, it is possible to design extraordinarily valuable feeder rods that feature extreme casting power.

The X45 design cares for distortion-proof blanks and accurate casts also over long distances.

The N'Zon Distance Special feeder rods are also excelled by their considerably low weight as well as their high durability – perfect for reliably casting heavy feeders to long distances without effort. The comprehensive lineup of this series covers almost all fields of application of feeder fishing. The rods with 90g and 120g casting weight are perfect for fishing in large, silent waters and at low current. The models with 150g and 180g have been designed for the application at strong current and heavy feeders. Also perfect for large carps.

To facilitate the use of shockleaders, the rods with 150g and 180g casting weight feature somewhat larger guides at the quiver tips. Equipped with original Fuji DPS Down-Lock reel seat, lightweight Seaguide guides and the exclusive DAIWA Armlock handle with cork and EVA these rods meet the expectations even of highest quality standards.

Art.-No.	Length m	Length ft	CW g	Action	Closed L. cm	Sect.	Guides	Weight g
11171-360	3.66	12.0	90	fast	187	2+3	15	225
11172-360	3.66	12.0	120	fast	129	3+3	15	230
11173-360	3.66	12.0	150	fast	129	3+3	15	235
11171-390	3.96	13.0	120	fast	138	3+3	15	255
11172-390	3.96	13.0	150	fast	138	3+3	15	265
11173-390	3.96	13.0	180	fast	138	3+3	15	270
11172-420	4.27	14.0	150	fast	149	3+3	14	270
11173-420	4.27	14.0	180	fast	149	3+3	14	280



- HVF® Nanoplus carbon fiber blank
- X45® carbon fiber construction
- V-Joint® put-over joint
- Separated Hard EVA / cork grip
- Fuji® DPS reel seat
- Seaguide® Zirconia guides
- Hook keeper



HVF
nanoplus

X45

V-JOINT

FEATURING
Fuji
REELSEAT

N'ZON DISTANCE SPECIAL METHOD FEEDER

METHOD FEEDER ROD | CW -80G

The Method Feeder rods from the N'Zon Distance Special feeder series is both applicable for method feeder fishing close to the shore and over long distances thanks to its semi-parabolic action. The 3.35m model with a casting weight of 80g despite its parabolic action offers enough reserves to control also large specimen easily.

The X45 blank design in combination with the exclusive DAIWA rod manufacturing technologies like HVF and nanoplus lead to a distortion-proof rod with high resilience – perfect for long and accurate casts. During the fight all flights are effortlessly buffered and the risk of losses at the use of thin lines is considerably decreased.

Art.-No.	Length m	Length ft	CW g	Action	Closed L. cm	Sect.	Guides	Weight g
11170-330	3.35	11.0	80	fast	172	2+3	15	200

N'ZON SUPER SLIM FEEDER

The N'Zon Super Slim Feeder rods offer optimal casting characteristics and highest resilience with very slim blank diameters. The rods of this large range are outstandingly well balanced! The HMC+ carbon fiber blank of the N'Zon Super Slim immediately resiles after the cast and thus enables especially precise targeting. The Armlock handle section is smoothly docking to the underarm and thus enormously improves comfort during the fight with powerful fish.

The N'Zon Super Slim series covers all kinds of modern feeder fishing. You will find rods for light method feeder fishing and fishing over short as well as great distances. Also for fishing in strong currents as well as for fishing for big carps, this range contains a fitting model.



HIGH MODULUS CARBON PLUS



PRECISION ROD COMPONENTS

- HMC+® carbon fiber blank
- ArmLock® handle section
- Cork / EVA grip
- Screw-down reel seat
- Seaguide® guides



N'ZON SUPER SLIM METHOD FEEDER

METHOD FEEDER ROD | CW -30G | -40G | -60G

Semi-parabolic method feeder rod for fishing for carp, bream and tench.

The blank of the Super Slim Method Feeder enables sensitive casts without losing feeder. The soft action reduces losses during the fight, but is also strong enough to cast precisely.

Art.-No.	Length m	Length ft	CW g	Action	Closed L. cm	Sect.	Guides	Weight g
11160-270	2.74	9.0	-30	medium fast	142	2+2	14	140
11160-300	3.05	10.0	-40	medium fast	157	2+2	15	155
11160-330	3.35	11.0	-60	medium fast	173	2+2	15	175

N'ZON SUPER SLIM FEEDER

FEEDER ROD | CW -90G | -120G

The Super Slim Feeder rods with 90g or 120g casting weight are made for fishing over great distances. The fast, stiff blank fully loads during the cast and precisely reaches great distances with feeders.

Ideally suited for big quarry ponds and natural ponds as well as rivers and canals. Real allrounders!

Art.-No.	Length m	Length ft	CW g	Action	Closed L. cm	Sect.	Guides	Weight g
11162-360	3.66	12.0	-90	medium fast	188	2+2	15	215
11163-360	3.66	12.0	-120	medium fast	128	3+2	15	260
11162-390	3.96	13.0	-120	medium fast	138	3+2	15	265



N'ZON SUPER SLIM POWER FEEDER

FEEDER ROD | CW -50G | -100G | -150G

The Power Feeder models are very strong feeder rods with great power reserves. Ideally suited for fishing over great distances or in strong currents. The fast action of the blank enables long and targeted casts. The guides have been chosen to fit even with thicker shock leaders.

Art.-No.	Length m	Length ft	CW g	Action	Closed L. cm	Sect.	Guides	Weight g
11161-300	3.05	10.0	-50	medium fast	157	2+2	15	165
11161-330	3.35	11.0	-100	medium fast	118	3+2	14	210
11163-300	3.00	10.0	-150	medium fast	157	2+2	14	205
11163-330	3.30	11.0	-150	medium fast	117	3+2	14	220
11161-360	3.66	12.0	-150	medium fast	128	3+2	15	260
11161-390	3.96	13.0	-150	medium fast	138	3+2	15	300

NEW

NEW

N'ZON SUPER SLIM CARP FEEDER

FEEDER ROD | CW -180G | -240G

The Carp Feeder models of the N'Zon Super Slim series are made for uncompromising application at fishing for big carps. Fish up to 30 pound can be fought easily with this powerful rod. Of course, the N'Zon Super Slim Carp is also fitting for usage at big rivers. Casting weights up to 240g offer the possibility to cast big and heavy feeders over great distances.

Art.-No.	Length m	Length ft	CW g	Action	Closed L. cm	Sect.	Guides	Weight g
11164-360	3.66	12.0	-180	medium fast	128	3+2	15	255
11164-390	3.96	13.0	-180	medium fast	138	3+2	15	290
11165-360	3.66	12.0	-240	medium fast	128	3+2	15	265
11165-390	3.96	13.0	-240	medium fast	138	3+2	15	305



N'ZON FEEDER

The N'Zon feeder series offers a broad range of rods for diverse types of application at feeder fishing. Depending on the model these rods can be used from light method feeder fishing in ponds to extra-heavy feeder fishing in large currents. The whole series is distinguished by their slim and well-balanced blanks with high resilience. The exclusive DAIWA Armlock handle is pleasant to grab and does not twist under strain.



HIGH MODULUS CARBON PLUS

- HMC+® carbon fiber blank
- Put-over joint
- ArmLock® handle section
- 2 carbon fiber quiver tips



N'ZON MINI METHOD FEEDER

METHOD FEEDER ROD | CW -30G | -40G | -50G | -60G

Classical method feeder rods with parabolic action. These rods allow smooth casts without losing the groundbait. Sudden and strong runs are perfectly absorbed and the threat of losses is reduced. Preferred field of application: ponds & lakes.

Art.-No.	Length m	CW g	Action	Closed L. cm	Sect.	Guides	Weight g
11130-270	2.75	-30	progressive	143	2+2	14	140
11130-300	3.05	-40	progressive	157	2+2	15	165
11130-330	3.35	-50	progressive	172	2+2	16	180
11330-360	3.65	-60	progressive	188	2+2	16	215

N'ZON LIGHT / MEDIUM FEEDER

FEEDER ROD | CW -60G | -80G

Pleasantly lightweight and well-balanced rods with very fast action and strong backbone. These rods cast also low weights to long distances. Under strain the action changes, resulting in a semi-parabolic bending curve. Perfect for ponds and light current.

Art.-No.	Length m	CW g	Action	Closed L. cm	Sect.	Guides	Weight g
11130-333	3.35	-60	progressive	117	3+2	15	190
11330-364	3.66	-80	progressive	127	3+2	15	235
11330-394	3.96	-80	progressive	138	3+2	15	255



11130-330

11131-395

11132-366

N'ZON POWER FEEDER

FEEDER ROD | CW -100G

Strong feeder rods with large power reserves – perfect for medium current or extreme distances at lakes. With very fast tip action.

Art.-No.	Length m	CW g	Action	Closed L. cm	Sect.	Guides	Weight g
11331-365	3.66	-100	medium fast	127	3+2	15	245
11131-395	3.96	-100	medium fast	138	3+2	15	270

N'ZON DISTANCE FEEDER

FEEDER ROD | CW -120G

Classical feeder rods for medium to strong current and heavy feeders.

These rods allow an enormous acceleration of the rig at casting. With the support of the strong blank heavy feeders can be presented with great precision. These rods feature somewhat larger guides at the quiver tips – perfect when shockleaders are used.

Art.-No.	Length m	CW g	Action	Closed L. cm	Sect.	Guides	Weight g
11332-360	3.66	-120	medium fast	127	3+2	14	265
11332-390	3.96	-120	medium fast	138	3+2	14	290

N'ZON XL DISTANCE FEEDER

FEEDER ROD | CW -150G

Extra-strong feeder rods for fishing with heavy feeders in strong current.

The N'Zon XL Distance feeder rods allow an enormous acceleration of the rig at casting. With the support of the extra strong blank heavy feeders can be presented with great precision. These rods feature somewhat larger guides at the quiver tips – perfect when shockleaders are used.

Art.-No.	Length m	CW g	Action	Closed L. cm	Sect.	Guides	Weight g
11332-300	3.00	-150	medium fast	157	2+2	13	225
11332-330	3.30	-150	medium fast	117	3+2	14	245
11332-366	3.66	-150	medium fast	127	3+2	14	280
11332-396	3.96	-150	medium fast	138	3+2	14	295

NEW

NEW



- HMC+® carbon fiber blank
- ArmLock® handle section
- Premium EVA grip
- Screw-down reel seat
- Titanium oxide guides



HIGH MODULUS CARBON PLUS

N'ZON PBR FEEDING

FEEDER ROD | 60M | 90M

With the two N'Zon Prebait-Feeding rods DAIWA offers special rods for the quick preparation of the feeding spot.

To achieve a successful feeding spot with a high fish density it is often important to quickly get large amounts of bait to the spot right at the beginning. The N'Zon Feeding rods with robust HMC+ carbon fiber blanks allow the use of very large feeders or bait rockets for the precise placement of groundbait and other bait types. The application of bait rockets allows the use of large amounts of particles and corn, that usually don't stick too well in conventional feeders.

The blank design and the used components have been selected to resist maximal load. Both rods can be used with all common bait rocket sizes. Available in two versions – 3.66m for distances of up to 60m and 3.96m for distances of up to 90m.

Art.-No.	Length m	Length ft	Action	Closed L. cm	Sect.	Guides	Weight g
11166-360	3.66	12.0	fast	127	3	9	241
11166-390	3.96	13.0	fast	138	3	9	342



11166-360



11333-330



- HMC+® carbon fiber blank
- ArmLock® handle section
- Cork / EVA grip
- Screw-down reel seat
- Titanium oxide guides
- 2 carbon fiber quiver tips



HIGH MODULUS CARBON PLUS

N'ZON EXTENSION FEEDER

FEEDER ROD | CW -40G | -50G | -80G | -120G

The N'Zon Extension feeder rods are equipped with a telescopic handle and thus can be transported space-savingly. The HMC+ carbon fiber blank is – despite its special construction – very lightweight and well balanced. Thanks to the Armlock handle section, absolute control during the fight is guaranteed – the rod's handle smoothly and steadily docs to the underarm thanks to its broad, flattened center section. The lineup offers fitting rods for sensitive method feeder fishing as well as for long distance fishing at great waters. Both delivered carbon fiber tips detect bites absolutely reliably.

Art.-No.	Length m	Length ft	CW g	Action	Closed L. cm	Sect.	Guides	Weight g
11333-300	3.05	10.0	-40	medium fast	140	2+2	15	175
11333-330	3.35	11.0	-50	medium fast	150	2+2	16	195
11333-360	3.65	12.0	-80	medium fast	165	2+2	15	255
11333-390	3.96	13.0	-120	medium fast	178	2+2	15	315



11334-390

- HMC+® carbon fiber blank
- ArmLock® handle section
- DPS reel seat
- Aluminum oxide guides



HIGH MODULUS CARBON PLUS

N'ZON TELE FEEDER

NEW

TELE FEEDER ROD | CW -60 | -90 | -120 | -150

With the N'Zon Tele Feeder rods, DAIWA now additionally offers telescopic feeder rods in the popular N'Zon product range, that can be transported in a space-saving manner. The thin, high-quality HMC+ carbon fibre blanks impress with their very light weight, excellent balance and exceptionally good action. Despite multiple sections, the rods react extremely quickly and offer enough power in the backbone to cope even the biggest target fish. Wrapped guides, a screw-down DPS reel seat and the ergonomically shaped handle made of cork and EVA, provide a high-quality appearance. The line-up of N'Zon Tele Feeder rods offers models for almost all common areas of feeder fishing – a progressive rod with a casting weight of 60g is specially designed for Method feeder fishing.

DAIWA offers rods with casting weights up to 90g or 120g for light to medium feeder fishing at closer range and a long cast model for ponds, lakes and canals. For heavy fishing in strong currents or with large, heavy cages, the rod with 150g casting weight and oversized guides on the quiver tips is the right choice.

The N'Zon Tele Feeder rods are supplied with two quivers.

Art.-No.	Length m	CW g	Action	Closed L. cm	Sect.	Guides	Weight g
11334-300	3.00	60	medium fast	73	6+2	12	160
11334-330	3.30	90	medium fast	73	6+2	12	205
11334-360	3.60	120	medium fast	84	6+2	12	240
11334-390	3.90	150	medium fast	86	7+2	13	300



11334-300

CQ QUIVER TIPS FOR N'ZON FEEDER

Art.-No.	Matching with Rod(s) Art.-No.	Matching with Rod(s) CW g	Material	Color	Type	TC oz
11333-030	11160-270, 11160-300, 11160-330, 11161-300, 11130-333, 11130-300, 11130-330, 11333-300, 11333-330, 11334-300, 11130-270, 11330-360	-40/-50	full carbon fiber	nightglow	MHQ	3.00
11135-020	11160-270, 11160-300, 11160-330, 11161-300, 11130-333, 11130-300, 11130-330, 11333-300, 11333-330, 11334-300, 11130-270, 11330-360	-40/-50/-60	full carbon fiber	red	MQ	2.00
11135-015	11160-270, 11160-300, 11160-330, 11161-300, 11130-333, 11130-300, 11130-330, 11333-300, 11333-330, 11334-300, 11130-270, 11330-360	-40/-50/-60	full carbon fiber	fluo yellow	MLQ	1.50
11135-010	11160-270, 11160-300, 11160-330, 11161-300, 11130-333, 11130-300, 11130-330, 11333-300, 11333-330, 11334-300, 11130-270, 11330-360	-40/-50/-60	full carbon fiber	fluo orange	LQ	1.00
11135-075	11160-270, 11160-300, 11160-330, 11161-300, 11130-333, 11130-300, 11130-330, 11333-300, 11333-330, 11334-300, 11130-270, 11330-360	-40/-50/-60	full carbon fiber	white	ULQ	0.75

CT QUIVER TIPS FOR N'ZON FEEDER

Art.-No.	Matching with Rod(s) Art.-No.	Matching with Rod(s) CW g	Material	Color	Type	TC oz
11138-050	11161-330, 11161-360, 11161-390, 11162-360, 11162-390, 11163-360, 11164-360, 11164-390, 11165-360, 11165-390, 11330-364, 11331-365, 11332-360, 11332-366, 11330-394, 11131-395, 11332-390, 11332-396, 11333-360, 11333-390, 11170-330, 11171-360, 11172-360, 11173-360, 11171-390, 11172-390, 11173-390, 11172-420, 11173-420, 11334-330, 11334-360, 11334-390, 11332-300, 11332-330, 11163-300, 11163-330, 11185-390	-80/-90/-100/-120/-150/-180	full carbon fiber	fluo orange	XHQ	5.00
11138-040	11161-330, 11161-360, 11161-390, 11162-360, 11162-390, 11163-360, 11164-360, 11164-390, 11165-360, 11165-390, 11330-364, 11331-365, 11332-360, 11332-366, 11330-394, 11131-395, 11332-390, 11332-396, 11333-360, 11333-390, 11170-330, 11171-360, 11172-360, 11173-360, 11171-390, 11172-390, 11173-390, 11172-420, 11173-420, 11334-330, 11334-360, 11334-390, 11332-300, 11332-330, 11163-300, 11163-330, 11185-390	-80/-90/-100/-120/-150/-180	full carbon fiber	green	HQ	4.00
11138-030	11161-330, 11161-360, 11161-390, 11162-360, 11162-390, 11163-360, 11164-360, 11164-390, 11165-360, 11165-390, 11330-364, 11331-365, 11332-360, 11332-366, 11330-394, 11131-395, 11332-390, 11332-396, 11333-360, 11333-390, 11170-330, 11171-360, 11172-360, 11173-360, 11171-390, 11172-390, 11173-390, 11172-420, 11173-420, 11334-330, 11334-360, 11334-390, 11332-300, 11332-330, 11163-300, 11163-330, 11185-390	-80/-90/-100/-120/-150/-180	full carbon fiber	nightglow	MHQ	3.00
11138-020	11161-330, 11161-360, 11161-390, 11162-360, 11162-390, 11163-360, 11164-360, 11164-390, 11165-360, 11165-390, 11330-364, 11331-365, 11332-360, 11332-366, 11330-394, 11131-395, 11332-390, 11332-396, 11333-360, 11333-390, 11170-330, 11171-360, 11172-360, 11173-360, 11171-390, 11172-390, 11173-390, 11172-420, 11173-420, 11334-330, 11334-360, 11334-390, 11332-300, 11332-330, 11163-300, 11163-330, 11185-390	-80/-90/-100/-120/-150/-180	full carbon fiber	red	MQ	2.00
11138-015	11161-330, 11161-360, 11161-390, 11162-360, 11162-390, 11163-360, 11164-360, 11164-390, 11165-360, 11165-390, 11330-364, 11331-365, 11332-360, 11332-366, 11330-394, 11131-395, 11332-390, 11332-396, 11333-360, 11333-390, 11170-330, 11171-360, 11172-360, 11173-360, 11171-390, 11172-390, 11173-390, 11172-420, 11173-420, 11334-330, 11334-360, 11334-390, 11332-300, 11332-330, 11163-300, 11163-330, 11185-390	-80/-90/-100/-120/-150/-180	full carbon fiber	fluo yellow	MLQ	1.50
11138-010	11161-330, 11161-360, 11161-390, 11162-360, 11162-390, 11163-360, 11164-360, 11164-390, 11165-360, 11165-390, 11330-364, 11331-365, 11332-360, 11332-366, 11330-394, 11131-395, 11332-390, 11332-396, 11333-360, 11333-390, 11170-330, 11171-360, 11172-360, 11173-360, 11171-390, 11172-390, 11173-390, 11172-420, 11173-420, 11334-330, 11334-360, 11334-390, 11332-300, 11332-330, 11163-300, 11163-330, 11185-390	-80/-90/-100/-120/-150/-180	full carbon fiber	white	LQ	1.00



N'ZON SWIVELS & BEADS



N'ZON FEEDER BEAD / SAFETY SNAP

FEEDER BEAD SWIVEL WITH SNAP

Can be connected directly to the main line or to the loop. Thanks to the snap, the feeder can be changed very quickly.

Art.-No.	Content pc.
13310-010	6



N'ZON DOUBLE SWIVEL

FEEDER DOUBLE SWIVEL

This double swivel reliably eliminates tangles during retrieving the rig. The dull surface reduces frightening under water.

Art.-No.	Swivel Size	Content pc.
13313-008	8	6
13313-010	10	6
13313-012	12	6



N'ZON QUICK-CHANGE SWIVEL

FAST LOCK SWIVEL

With this fast lock swivel, your rig can be changed within seconds. No additional knots are necessary. Ideal when your rig has to be adapted very often to different fishing conditions.

Art.-No.	Swivel Size	Content pc.
13316-010	10	10
13316-012	12	10
13316-014	14	10



N'ZON SWIVEL

FEEDER SWIVEL

Classical feeder swivel. The dull surface reduces frightening under water significantly.

Art.-No.	Swivel Size	Content pc.
13312-008	8	10
13312-010	10	10
13312-012	12	10



N'ZON SWIVEL / SNAP

FEEDER SWIVEL WITH SNAP

Premium feeder swivel with snap.

Art.-No.	Swivel Size	Content pc.
13314-008	8	10
13314-010	10	10
13314-012	12	10



N'ZON SWIVEL & STOP BEAD

METHOD STOPPER BEAD | WITH SWIVEL

Stopper bead with integrated swivel for modern feeder fishing.

Art.-No.	Size	Content pc.
13317-010	M	10
13317-008	L	10



N'ZON FEEDER STOPS

RUBBER STOPPER

Premium feeder stops in three different sizes.

Art.-No.	Size	Content pc.
13310-114	S	15
13310-110	M	15
13310-108	L	15



N'ZON DOUBLE SWIVEL / SNAP

FEEDER DOUBLE SWIVEL WITH SNAP

Special double swivel with snap. The double swivel eliminates tangling reliably.

Art.-No.	Swivel Size	Content pc.
13315-008	8	8
13315-010	10	8
13315-012	12	8



N'ZON QUICK-CHANGE BEAD

METHOD FEEDER BEAD

Sophisticated quick-change bead for feeder fishing.

Art.-No.	Content pc.
13318-001	8

N'ZON FEEDERS & LEADS



N'ZON OPEN END FEEDER

OPEN FEEDER | FOR STILL WATERS

Classical round plastic feeder. This feeder rises to the surface very quickly during retrieving. Ideal in silent waters with much vegetation and barriers under water. Additionally the groundbait fades out of the Open End Feeder more slowly compared to wire feeders.

Art.-No.	Feeder Size	Weight g	Content pc.
13350-030	S	30.0	1
13351-020	M	20.0	1
13351-030	M	30.0	1
13351-040	M	40.0	1
13351-050	M	50.0	1
13352-030	L	30.0	1
13352-040	L	40.0	1
13352-050	L	50.0	1
13352-060	L	60.0	1
13352-080	L	80.0	1

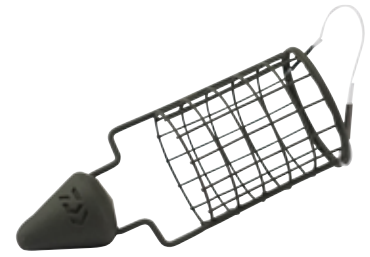

N'ZON DISTANCE CAGE FEEDER

LONGCAST FEEDER | FOR STILL WATERS

Feeder for distance hunters. Ideal when the feeder shall be presented over great distances. The dull surface prevents frightening even of shy fish. Ideal for silent waters.

Art.-No.	Feeder Size	Weight g	Content pc.
13331-020	M	20.0	1
13331-030	M	30.0	1
13331-040	M	40.0	1
13331-050	M	50.0	1
13331-060	M	60.0	1
13332-020	L	20.0	1
13332-030	L	30.0	1
13332-040	L	40.0	1
13332-050	L	50.0	1
13332-060	L	60.0	1



N'ZON CAGE FEEDER

OPEN FEEDER

Classical round feeder – available in 3 sizes. Due to the special positioning of the lead, the feeder can be cast very precisely and without flapping. The dull surface prevents frightening even of shy fish.

Art.-No.	Feeder Size	Weight g	Content pc.
13321-020	M	20.0	1
13321-030	M	30.0	1
13321-040	M	40.0	1
13323-030	L	30.0	1
13323-040	L	40.0	1
13323-050	L	50.0	1
13323-060	L	60.0	1
13323-080	L	80.0	1
13324-030	XL	30.0	1
13324-040	XL	40.0	1
13324-050	XL	50.0	1
13324-060	XL	60.0	1
13324-080	XL	80.0	1



N'ZON TUNNEL CAGE FEEDER

OPEN FEEDER | FOR STILL AND CURRENT WATERS

Effective feeder with great capacity. This feeder can be fished in currents as well as in ponds and lakes. Due to the tube shape, the groundbait can fade out perfectly and the feeder doesn't drift with the current that easily. The dull surface prevents frightening even of shy fish.

Art.-No.	Feeder Size	Weight g	Content pc.
13335-040	M	40.0	1
13335-050	M	50.0	1
13335-060	M	60.0	1
13335-080	L	80.0	1
13335-100	L	100.0	1
13335-120	L	120.0	1



N'ZON SQUARE CAGE FEEDER

OPEN FEEDER | FOR CURRENT WATERS

Classical square feeder for fishing in currents. The feeder gets down to the ground even at strong current and thus doesn't drift away that easy. The dull surface prevents frightening even of shy fish.

Art.-No.	Feeder Size	Weight g	Content pc.
13340-020	S	20.0	1
13340-030	S	30.0	1
13340-040	M	40.0	1
13340-050	M	50.0	1
13340-060	M	60.0	1
13340-080	L	80.0	1
13340-100	L	100.0	1
13340-120	L	120.0	1



N'ZON DUAL FEEDER ROD REST

Special rod rest for method feeder fishing. The rod rest features two areas – in the upper area the rod can easily be placed and grabbed – at the lower part the handle is secured at the rod rest and cannot be pulled out accidentally. Perfect for method feeder fishing and feeder fishing for carps, when quick bites and surprising runs have to be taken into account.

With English brass thread.



Art.-No.	Color	Size cm	Height cm	Weight g	Content pc.
13406-000	black/red	78x56	1,00	29	1



13309-300

13309-310

N'ZON EVA FEEDER REST

STRAIGHT

Art.-No.	Length cm	Content pc.
13309-300	30	1
13309-305	50	1

N'ZON EVA FEEDER REST

CURVED

Art.-No.	Length cm	Content pc.
13309-310	50	1

N'ZON WEIGHT CHANGE FEEDERS

Hybrid-style feeder – available in 3 sizes and many different weights. Due to the special, additionally available weight kit, the weight can be increased without the need for building a new rig. The special construction and shape ensure an optimal retaining of the feed during the cast and during sinking down. Due to the inline construction ECS (Easy Change System), these feeders can be changed quickly without new rigging. With camouflage soft-touch surface. Lead-free construction.

N'ZON WEIGHT CHANGE FEEDER

OPEN FEEDER



Art.-No.	Lead Size	Weight g	Content pc.
13345-720	S	20.0	1
13345-730	S	30.0	1
13345-825	M	25.0	1
13345-835	M	35.0	1
13345-845	M	45.0	1
13345-935	L	35.0	1
13345-950	L	50.0	1
13345-965	L	65.0	1

N'ZON WEIGHT CHANGE

Art.-No.	Lead Size	Weights g	Content Set pc.
13345-995	S	5.0+10.0	1+1

N'ZON X8 BRAID

BRAIDED LINE | STEEL GREY

Premium 8-strand braided line for feeder fishing. Thanks to the smooth surface this braided line crosses the guide almost completely silent and cares for optimal casting distances. The Japanese IZANAS PE fiber cares for a high abrasion resistance and high linear strength. Perfect for long distance fishing.

- IZANAS® PE fiber
- 8-Braid, round-braided
- Very high knot strength
- High abrasion resistance
- No stretch
- Made in Japan



Art.-No.	Color	Capacity m	Ø mm	Strength kg	Strength lb
12410-108	steel grey	150	0.08	5.00	11.0
12410-110	steel grey	150	0.10	7.00	15.0
12410-112	steel grey	150	0.12	8.50	19.0

Art.-No.	Color	Capacity m	Ø mm	Strength kg	Strength lb
12410-308	steel grey	300	0.08	5.00	11.0
12410-310	steel grey	300	0.10	7.00	15.0
12410-312	steel grey	300	0.12	8.50	19.0

N'ZON SINKING FEEDER MONO

FEEDER MONOFILAMENT | SINKING | MATT BROWN



- 150m color marker
- Sinking
- Low underwater reflection
- High suppleness

Premium sinking and very supple monofilament line for feeder fishing. The dull surface of the N'Zon Feeder Mono prevents underwater reflections.

The 300m spools feature a mark at 150m length – perfect to equip 2 reels with exactly 150m line.

Art.-No.	Color	Capacity m	Ø mm	Strength kg	Strength lb
12405-016	matt brown	300	0.16	1.69	4.0
12405-018	matt brown	300	0.18	2.35	5.0
12405-020	matt brown	300	0.20	3.08	6.0
12405-023	matt brown	300	0.23	3.92	8.0
12405-026	matt brown	300	0.26	4.99	10.0
12405-028	matt brown	300	0.28	5.72	12.0
12405-030	matt brown	300	0.30	6.39	14.0

N'ZON TAPERED SHOCK LEADER

TAPERED | GREY TRANSPARENT



- Tapered line construction
- Made in Japan

This shock leader for feeder fishing offers great advantages especially when applied at long range fishing – perfect for mussel banks and unclean bottom.

Length per item: 10m – 7m parallel and 3m with taper.
Content: 5 shock leaders

Art.-No.	Color	Version
12405-125	grey transparent	0.18-0.25mm 5x10m
12405-130	grey transparent	0.22-0.30mm 5x10m
12405-135	grey transparent	0.26-0.35mm 5x10m

N'ZON METHOD FEEDER

SPECIAL FEEDER

Premium method feeders available in three sizes with Easy-Grip camo surface.

These common and easily fillable method feeders have been developed together with our consultants from the UK. With aerodynamical Weight-Forward design for optimal and accurate casts. The centerline can conveniently be replaced via the exchange system, therefore eliminating the need of renewing the whole rig.

These feeders are made of lead-free material.

Art.-No.	Feeder Size	Weight g	Content pc.
13345-020	S	20.0	1
13345-030	S	30.0	1
13345-125	M	25.0	1
13345-135	M	35.0	1
13345-145	M	45.0	1
13345-235	L	35.0	1
13345-250	L	50.0	1
13345-265	L	65.0	1



S



M



L

N'ZON METHOD MOULD

SILICONE MOULD FOR N'ZON METHOD FEEDER

The matching silicone molds for the DAIWA method feeders. With extra-soft backpart for easy removal of the filled method feeder.

Available in 3 sizes: S, M, L



S



M



L

Art.-No.	Feeder Size	Size	Content pc.
13345-000	S	for Method Feeders sz. s	1
13345-100	M	for Method Feeders sz. M	1
13345-200	L	for Method Feeders sz. L	1

N'ZON SYSTEM 36 FEEDER CHAIR

WITH HIGH BACKREST

With this exclusive N'Zon feeder chair, which has been designed especially for the particular demands of modern feeder fishing, you are perfectly equipped for long sessions at the water.

All four legs feature mud feet at the end and their length can be adjusted individually to provide a safe footing even on rough ground. The extra-long back part can be adjusted perfectly to your posture. At the front, two round adapters fit with all common round feeder arms and add-ons with a diameter of 36mm. Both front parts can be adjusted regarding their height to your individual needs. To provide a completely tangle-free working area, the round locking knob can be turned away about 180 degree.

The end cap can be removed – you will find an English thread below, where you can mount e.g. a feeder rod rest or something similar.

Material: Cover polyester



Art.-No.	Size cm	Weight kg
13432-500	55x55x70	6.4



N'ZON UMBRELLA

ROUND | ARC MEASURE 250CM

Premium umbrella with double-stitched seams and sealing tape.
Arc measure: 250cm

Material: Umbrella cover polyester

Art.-No.	Model	Size cm	Weight kg
13432-250	NZB125	250	2.5



N'ZON UMBRELLA

SQUARE | ARC MEASURE 250CM

Premium umbrella with double-stitched seams and sealing tape.
Arc measure: 250cm

Material: Umbrella cover polyester

Art.-No.	Model	Size cm	Weight kg
13432-260	NZSB125	250	2.3

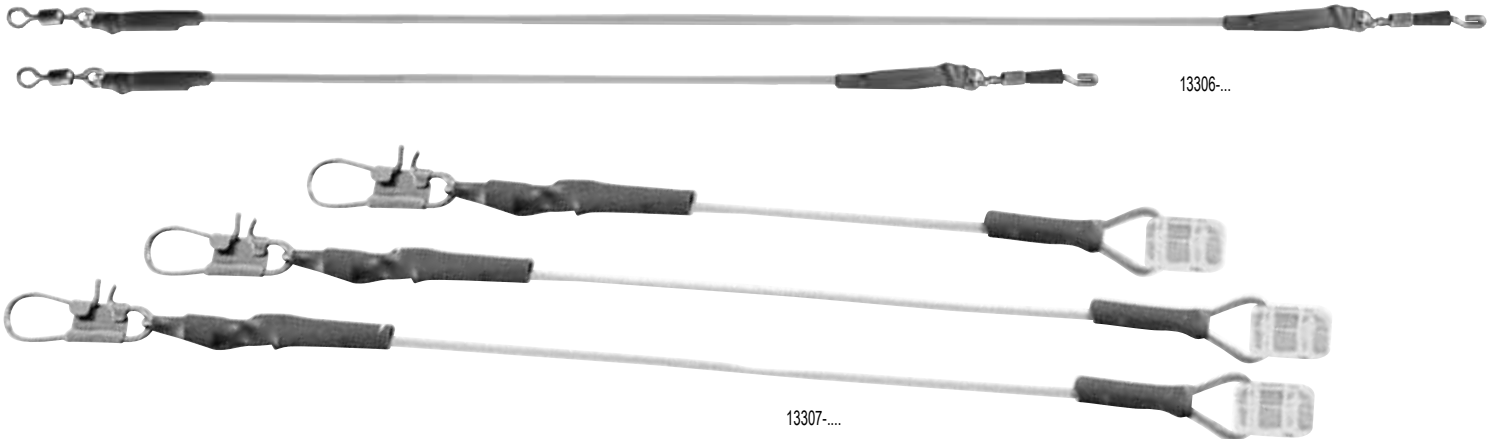

N'ZON POWER GUM FEEDER LINK

SHOCK ABSORBER FEEDER LINK

Ready-to-fish feeder link.

Art.-No.	Length cm	Ø mm	Strength kg	Content pc.
13306-110	10.0	0.8	6.0	3
13306-115	15.0	0.8	6.0	3

N'ZON SLIDING FEEDER LINK

MONOFIL FEEDER LINK | WITH SLIDING BEAD

Convenient feeder links. Rigged on 0.60mm mono line and original N'Zon sliding bead.

Art.-No.	Length cm	Content pc.
13307-004	4.0	3
13307-006	6.0	3
13307-008	8.0	3



N'ZON PELLET BAND EXTENDER

For easy opening of small pellet bands.

Art.-No.	PU pc.
13319-004	10



N'ZON BAIT DRILL

Bait drill for pellets and mini boilies. Floating and thus hard to get lost.

Art.-No.	PU pc.
13319-001	20



N'ZON BAIT NEEDLE

Bait needle for pellets and mini boilies. Floating and thus hard to get lost.

Art.-No.	PU pc.
13319-002	20



N'ZON QUICK STOP NEEDLE

Floating and thus hard to get lost.

Art.-No.	PU pc.
13319-003	20



N'ZON LOOP TYER

TYING AID FOR LOOP KNOTS

With this small loop tyer every single loop knot will be successful. Floating and thus hard to get lost.

Art.-No.	PU pc.
13319-005	20



N'ZON DISGORGER

DOUBLE-SIDED

Essential tool for safe and quick unhooking.

Art.-No.	PU pc.
13319-000	100



N'ZON POWER GUM

SHOCK ABSORBER | 10M SPOOL

Premium and elastic power gum (10m on spool). Ideally suited for feeder rigs and side rigs.

Art.-No.	Length m	Ø mm	Strength kg	Content pc.
13306-006	10.0	0.60	4.0	1
13306-008	10.0	0.80	6.0	1
13306-001	10.0	1.00	8.0	1

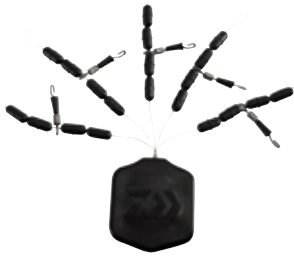

N'ZON HELI FEEDER RIG

HELICOPTER RUBBER STOPPER

For feeder heli-rigs. Can be easily threaded to the main line like a conventional rubber stopper bead.

Art.-No.	Size	Content pc.
13308-000	S	5
13308-001	M	5
13308-002	L	5



N'ZON BAYONET PIN

METAL BOILIE PINS

For rigging small boilies, pop-ups and soft-pellets.

Art.-No.	Length mm	Content pc.
13308-307	7	20
13308-311	11	20



N'ZON SPEED STOPS

BAIT STOPS

Art.-No.	Content pc.
13308-100	40



N'ZON DISTANCE STICKS

Premium aluminum distance sticks for feeder fishing. The package contains 2 sticks, 5m rope and a T-bar, which can be inserted into the sticks, to make it easier to get stuck into hard ground. The sticks have some grooves to prevent slipping of within using braided lines.

Material: Transportation bag polyester

Art.-No.	Weight g	Content pc.
13420-800	775	2



N'ZON SILICONE PELLET BAND

PELLET FIXATION

High-end stretchable pellet bands made of latex.

Art.-No.	Size	Ø mm	Content pc.
13308-202	S	2	100
13308-203	M	3	100



N'ZON EVA RIG FOAM SPOOLS

6 spools for storing ready-made rigs. The spools can be labeled easily.

Art.-No.	Content pc.
13309-001	6



N'ZON NEOPRENE ROD BAND SET

Neoprene rod straps - ideal for feeder rods.

Material: 90% neoprene, 10% nylon

Art.-No.	Content Set pc.
13432-000	2

N'ZON LANDING NET HEAD



N'ZON FAST FLOW LANDING NET HEAD

WITH WATER-REPELLENT MESH

The N'Zon Fast Flow landing net head is perfectly suited for fishing in currents. The somewhat wider meshes slide through the water without resistance and thus facilitate the landing. The mesh material nearly absorbs no water.

Material net: polyester

Art.-No.	Size cm
13410-055	55x45



N'ZON NANO MESH LANDING NET HEAD

WITH WATER-REPELLENT MESH

Classical all-round landing net head. The Nano-Mesh net material absorbs no water and can be dried easily by shaking. The landing net head is extremely lightweight and robust! Also big fish will find space in this landing net!

Material net: polyester

Art.-No.	Size cm
13415-055	55x45



N'ZON PELLET LANDING NET HEAD

WITH CLOSE-MESHED NET

This landing net head is equipped with small mesh to prevent slipping out of pellets and hooks, which can cause tanglings. Extremely lightweight and robust!

Material net: polyester

Art.-No.	Size cm
13420-050	50x40

N'ZON KEEP NET

NEW

Designed with a high endurance mesh and reinforced protection around each net ribs, the Power Mesh 350 is designed especially for rivers, big canals and wild waters where contact with rough ground and vertical surfaces are likely. Other features include a secure angle lock, pull through handles and stake out rings on the base.

Material net: polyester



Art.-No.	Length cm
13440-350	350

N'ZON KEEP NET

NEW

The N'Zon Soft Mesh net is well suited to Commercial fisheries and smaller waters where multiple nets are required. Features include a secure angle lock, pull through handles and stake out rings on the base.

Material net: polyester



Art.-No.	Length cm
13441-300	300



N'ZON SQUARE MESH LANDING NET

NEW

Where speed of netting (scooping) is likely or rapid movement through the water is required, the 6mm square shaped mesh reduces resistance. This soft and „fish friendly“ material is quick drying too.

Material net: polyester

Art.-No.	Size cm
13460-045	45x35
13460-055	55x45

N'ZON RUBBER MESH LANDING NET

NEW

The rubber coated mesh of this net is highly fish friendly, quick drying yet durable too. It resists hooks getting caught up. Perfect for bigger fish like carp and bream. Features include a rigid, lightweight aluminium frame.

Material net: polyester

Art.-No.	Size cm
13470-045	45x35
13470-050	50x40
13470-060	60x50



N'ZON SOFT & FINE MESH LANDING NET

NEW

LANDING NET HEAD

The soft, fine mesh is designed to suit use with hair rigged and banded baits in particular. The mesh is gentle on fine hook lengths and the super small holes prevent hair rigged baits and bait stops getting caught. Features include a rigid, lightweight aluminium frame.

Material net: polyester

Art.-No.	Size cm
13450-040	40x30
13450-050	50x40

N'ZON LANDING NET HANDLE

Very premium lightweight and stiff landing net handle made of HMC+ carbon fiber, which is perfectly balanced. The 1m extension fits to both versions, to use the landing net handle up to 5m. Both models have 2 threads in the sections, to enable to use it in a 4.0m as well as a 2.8m version.

N'ZON LANDING NET HANDLE FEEDER PRO



Art.-No.	Handle L. cm	Closed L. cm	Sect.	Weight g
13421-400	400	152	3	315

N'ZON LANDING NET HANDLE FEEDER



Art.-No.	Handle L. cm	Closed L. cm	Sect.	Weight g
13421-405	400	152	3	390

N'ZON LANDING NET HANDLE EXTENSION



Art.-No.	Handle L. cm	Closed L. cm	Sect.	Weight g
13421-001	100	100	1	100

N'ZON WINDOW FEEDER

FEEDER

This window feeder has especially been made for fishing and feeding with particles and ground bait and – due to the weight at the body's end – ensures very long and targeted casts. The stocky shape enables quick filling and an optimal diffusion of the feed as recently as the feeder reaches the ground. The big PB models (Pre-Baiting) have especially been made for transporting great amounts of feed to the fishing spot at the beginning.



PB L M S

N'ZON INLINE SWIVEL BOMB

FEEDER LEAD

Inline bomb with aerodynamic shape for great casting distances. The flat body shape cares for secure adhesion at the bottom and an optimal bite rate. Ideal for quick changes from feeder to bomb without building a new rig. The Inline-shaft fits with the Weight-Change feeders as well as the Inline method feeder of the N'Zon range. Lead-free!



Art.-No.	Weight g	Content pc.
13361-010	10.0	2
13361-020	20.0	2
13361-030	30.0	2
13361-045	45.0	2
13361-060	60.0	2

Art.-No.	Size	Weight g	Content pc.
13355-020	S	20.0	20
13355-030	S	30.0	20
13355-040	S	40.0	20
13355-050	S	50.0	20
13356-030	M	30.0	20
13356-045	M	45.0	20
13356-060	M	60.0	20
13356-075	M	75.0	20
13357-030	L	30.0	20
13357-045	L	45.0	20
13357-060	L	60.0	20
13357-075	L	75.0	20
13358-030	PB	30.0	20
13358-045	PB	45.0	20
13358-060	PB	60.0	20



N'ZON EVA BAGS

The innovative N'Zon System bag program has been made of premium, extra strong EVA material of 0.9mm thickness. The sealed seams offer enduring protection against soaking in of water. Within the N'Zon EVA bags all accessories are perfectly protected against outer harm. Additionally the surface can be cleaned easily.



N'ZON EVA FEEDER BAG

SEPARABLE | M-SIZE

This handy bag is separated in two main compartments. The upper storage compartment can be removed via hook and loop fastener and offers much space for big accessories. The lower one is delivered with 2 plastic boxes and offers much space for small pieces. The robust handles and the padded shoulder strap ensure optimal carrying comfort even when fully loaded.

Dimensions:

Lower compartment: 38x26x11cm
Upper compartment: 35x22x8cm

Material: Bag EVA

Art.-No.	Size	Size cm
13305-005	M	38x26x22



N'ZON EVA FEEDER BAG

SEPARABLE | L-SIZE

This premium bag got the "Best Product Award" at the Efttex 2019 and convinces by many details. The bag is separated in two main compartments. The upper storage compartment can be removed via hook and loop fastener and offers much space for big accessories. The lower compartment is delivered with 4 plastic boxes and offers much space for small pieces. Two additional side pockets with zipper offer space for documents, phone etc. The strong handles and the padded shoulder strap ensure optimal carrying comfort even when fully loaded.

Dimensions:

Lower compartment: 38x26x22cm
Upper compartment: 35x22x8cm

Material: Bag EVA

Art.-No.	Size	Size cm
13305-010	L	38x26x31



N'ZON EVA COOL BAG

WITH THERMO INSULATION

This premium cooler bag offers space for lures, drinks and food. The strengthened bottom and the overlapping lid ensure optimal solidity.

The robust handles and the padded shoulder strap ensure optimal carrying comfort even when fully loaded.

Dimensions: 40x25x27cm
Capacity: 26l

Material: Bag EVA

Art.-No.	Size cm	Volume l
13305-050	40x25x27	26



N'ZON EVA BARROW BAG

XL-SIZE

Simple but brilliant. A spacious bag for all accessories, you want to take with you in only one walk.

The waterproof bag has a capacity of 67l and can be sealed completely via lid zipper. The waterproof bottom prevents soaking in of moisture.

Ideal for transporting wet and dirty pieces within your car after a feeder session. Equipped with padded shoulder strap and carrying handles.

Dimensions: 70x40x25cm

Material: Bag EVA

Art.-No.	Size cm	Volume l
13305-080	70x40x25	67



N'ZON FOLDABLE EVA BUCKET

FOLDABLE | WITH CARRYING HANDLE AND ROPE

This foldable bucket with a capacity of 5l facilitates accessing water enormously. Equipped with extra-strong 10m rope and solid carrying handle.

Dimensions: 16x16x20cm

Material: Bucket EVA

Art.-No.	Size cm	Volume l
13305-105	16x16x20	5



N'ZON EVA KEEP NET BAG

The N'Zon keep net bag offers space for two keeping nets and a landing net head. The material prevents transpiration of moisture and odor until the content is removed for drying.

With strengthened upper rim, zipper, carrying handle and shoulder strap.

Dimensions: 60x55x20cm

Material: Bag EVA

Art.-No.	Size cm
13305-100	60x55x20



N'ZON EVA ACCESSORY CASE SET

L-SIZE

Three-piece set for the storage of different baits, maggots and particles. With strengthened rim and lid with zipper. Both smaller boxes can be inserted into the big one for transportation.

Dimensions:

Large box: 19x15x8cm

Small boxes: 13x7x8cm

Material: Box EVA

Art.-No.	Size	Size cm	Content Set pc.
13305-090	L	19x15x8	3

N'ZON EVA ACCESSORY CASE SET

XL-SIZE

This set contains three big boxes with lid and zipper. For accessories, groundbait, maggots, pellets, etc.

The big box is very handy for preparing feeder groundbait. Both smaller boxes fit exactly into the big one for transportation. With strengthened rim.

Dimensions:

XL box: 31x16x9cm

Large box: 21x15x7cm

Small box: 13x8x7cm

Material: Box EVA

Art.-No.	Size	Size cm	Content Set pc.
13305-095	XL	31x16x9	3



N'ZON EVA BAIT BOWL SET

XL-SIZE

This set contains three boxes for groundbait, maggots, pellets etc.

The big box is perfectly applicable for preparing feeder groundbait. Both smaller boxes fit exactly into the big one for transportation.

Dimensions:

XL box: 32x17x8cm

Large box: 19x15x8cm

Small box: 15x12x8cm

Material: Box EVA

Art.-No.	Size	Size cm	Content Set pc.
13305-086	XL	32x17x8	3



N'ZON EVA SYSTEM SET



The N'Zon EVA system set contains 8 pieces with differently sized boxes for bait, groundbait as well as feeders, leads and additional accessories. The smaller boxes fit exactly into the big main bag and thus can be stored and transported easily. Six boxes have a clear lid with zipper, two are open.

Dimensions: 41x34x10cm

Capacity: 25l

Material: Box EVA

Art.-No.	Size cm	Volume l	Content Set pc.
13305-000	41x34x10	25	8

N'ZON BAGS



N'ZON CARRYALL COOL BAG

COOLING BAG

This cooler bag with a capacity of 40l can easily be opened and filled from the top. The thermo isolation ensures an enduring cooling effect. The solid bottom prevents soaking in of moisture and keeps the bag in shape even when fully loaded. An additional pocket with zipper offers further storage space.

Equipped with padded shoulder strap which ensures optimal carrying comfort even when heavily loaded.

Material: Bag nylon

Art.-No.	Size cm	Volume l
13405-005	50x28x30	40



N'ZON BAIT BAG

WITH THERMO INSULATION

This extra big cooler bag with a volume of 60l offers enormous storage space for lures and foods. The strong thermo isolation keeps the content cold enduringly even under warm temperatures. The four big superimposed pockets with zippers offer additional storage space for bottles, flavours and other accessories.

Equipped with strengthened bottom and padded shoulder strap.

Material: Bag nylon

Art.-No.	Size cm	Volume l
13405-010	48x32x32	60



N'ZON TACKLE BAG

M-SIZE

This tackle bag with strengthened bottom offers much storage space for all small pieces you need during a fishing session. The lower compartment contains 3 tackle boxes for feeders and other items – at the flap's inside, an additional, shallow pocket with zipper hosts documents, key, etc. The upper, padded compartment can be separated in different sections via hook and loop fastener. Within the lid an additional zipper pocket hosts small pieces, phone etc. The rubberized bottom prevents soaking in of moisture via the bottom.

Equipped with padded shoulder strap and carrying handle with hook and loop fastener.

Dimensions:

Lower compartment: 30x20x16cm
Upper compartment: 30x20x9cm

Material: Bag nylon

Art.-No.	Size	Size cm
13405-050	M	30x20x25

N'ZON TACKLE BAG

L-SIZE

This extra big front loader tackle bag is delivered with 3 big tackle boxes with much space for accessories and small pieces. At the flap's inside an additional, shallow pocket hosts documents etc. The upper, padded compartment can be separated in different sections via hook and loop fastener. Within the lid an additional zipper pocket hosts small pieces, phone etc. The rubberized bottom prevents soaking in of moisture via the bottom.

Equipped with padded shoulder strap and carrying handle with hook and loop fastener.

Dimensions:

Lower compartment: 38x24x18cm
Upper compartment: 38x23x9cm

Material: Bag nylon

Art.-No.	Size	Size cm
13405-020	L	38x24x28



N'ZON 2 ROD BAG

FEEDER ROD HOLDALL | FOR 2 MOUNTED RODS

This rod bag offers a strengthened backside and a strong bottom and is able to host 2 rigged rods. The rods can be positioned in a way to separate the reels from each other and thus prevent damages. The inner divider prevents scratching of the rods against each other.

The outer pockets offer space for umbrella as well as quiver tips and banksticks.

Equipped with padded shoulder strap and neoprene handles.

Dimensions outer pockets:

- 155x5x12cm
- 58x10x4cm
- 82x7.5cm

Material: Bag nylon

Art.-No.	Size cm	Version
13401-005	180x19x17	for 2 rods

N'ZON 4 ROD BAG

FEEDER ROD HOLDALL | FOR 4 MOUNTED RODS

This rod bag offers a strengthened backside and a strong bottom and is able to host 4 rigged rods. The rods can be positioned in a way to separate the reels from each other and thus prevent damages. The inner divider prevents scratching of the rods against each other.

Three outer pockets offer space for umbrella as well as quiver tips and banksticks.

Equipped with padded shoulder strap and neoprene handles.

Dimensions outer pockets:

- 155x12x5cm
- 58x10x4cm
- 82x7.5cm

Material: Bag nylon

Art.-No.	Size cm	Version
13401-010	180x26x26	for 4 rods

13401-005

13401-010



YOUR ADVANTAGE: A SPECIFICALLY DEVELOPED BAITMIX.

Thanks to the support and the knowledge of World and European champions we developed a range of premium groundbaits and hook baits, which are ready-to-fish and have proven their quality and catchiness in many tests. All Advantage groundbaits are designed in a way to start working directly after adding water and suspend their attractants and particles to entice and maintain fish at the feeding spot.

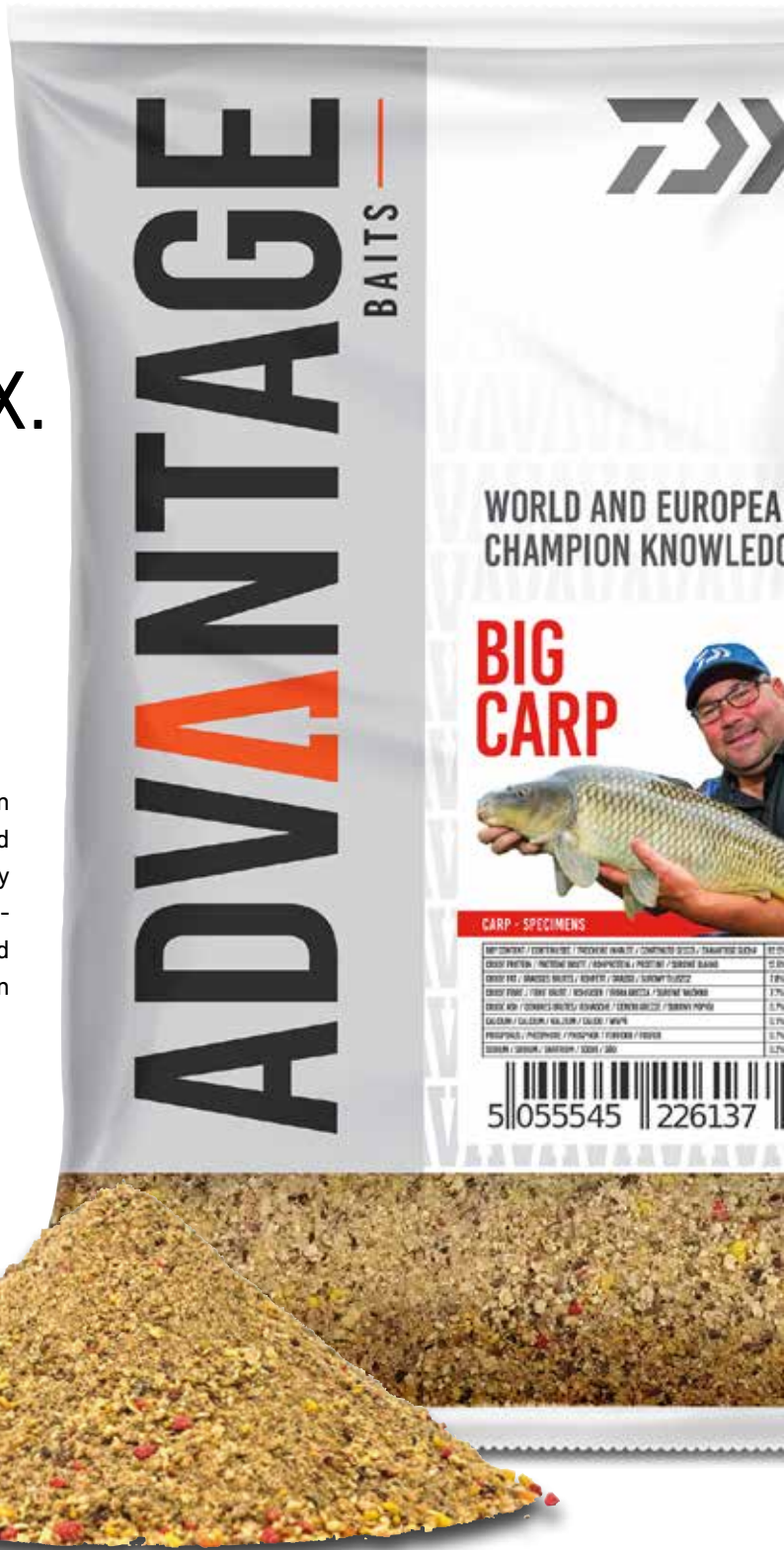

ADVANTAGE

BAITS



ADVANTAGE

BAITS

ADVANTAGE GROUNDBAIT MIX

Thanks to the support and the knowledge of World and European champions we developed a range of premium groundbaits which are ready-to-fish and have proven their outstanding quality and catchiness in many tests.

- Premium bait, developed by World and European champions
- Proven quality and attractiveness
- Ready-to-use



GREEN BREEM MIX

Especially developed to attract and retain big breams at the spot. The amount of fishmeal has been chosen in a way to fit to the active food search during the warm summer season as well as to less active fish within cold waters. Green Bream is grounded somewhat coarser to dissolve faster at the ground.



ALL-ROUND MIX

Ideal all-round groundbait, which works optimally in ponds as well as in large waters. This groundbait can be fished the whole year and contains a medium amount of fishmeal, which has been proved for a long time. Ideal mix for feeder as well as for pole fishing for carp, bream and roach.



F1 - SMALL CARP MIX

Especially for small, very active carps and tenches. Thanks to the usage of grounded fishmeal pellets, this groundbait absorbs much water and thus produces a big groundbait cloud, which attracts fish over great distances. Ideal for fishing in shallow water areas.

Art.-No.	Description	Content kg
13300-001	green bream mix	1

Art.-No.	Description	Content kg
13300-002	all-round mix	1

Art.-No.	Description	Content kg
13300-003	F1 - small carp mix	1



METHOD MIX

Despite the fine structure, the Method Mix starts working immediately at the ground. During the cast nearly no bait is getting lost – but you can be sure it will promptly produce a cloud at the bottom and release your hook bait. The amount of fishmeal is somewhat lower than in other groundbait mixes and thus doesn't satiate the fish that fast.

Art.-No.	Description	Content kg
13300-004	method mix	1



BIG CARP MIX

This kind of groundbait absorbs much water to produce a heavy and longlasting mix. Mixed with coarse, visible particles to produce a cloud, which maintains fish at the spot for a long time. Thanks to the stickiness, you can add a great amount of loose baits like corn and maggots. With little amount of fishmeal.

Art.-No.	Description	Content kg
13300-005	big carp mix	1



ALL-ROUND BLACK MIX

This black all-round version is perfectly suited for clear water and big natural lakes. With medium amount of fishmeal. Can be combined ideally with other groundbait mixes. The Allround-Black also is a great groundbait for the cold season, because it doesn't satiate the fish that fast. Thanks to the stickiness you can add a great amount of natural bait like maggots, worms and pellets. Classical all-round mix for roaches, breams and smaller carps.

Art.-No.	Description	Content kg
13300-006	all-round black mix	1



METHOD MIX BLACK

Despite the fine structure, the Method Mix starts working immediately at the ground and will promptly produce a bait cloud. During the cast nearly no bait is getting lost. With small amount of fishmeal, to keep the fish active. Ideally suited for highly frequented, clear waters as well as fishing in the cold season. Can be mixed with up to 50% with micro-pellets and sticks great to all commonly used feeders.

Art.-No.	Description	Content kg
13300-007	method mix black	1



RIVER MIX

Groundbait with high stickiness, which can be spiced up with a great amount of particles and natural bait. During sinking, nearly no bait gets lost – while at the bottom the groundbait dissolves fast and creates a track to the bait. With big particle content (hemp and coriander seed). Ideal for deep water and strong current.

Art.-No.	Description	Content kg
13300-008	river mix	1



SWEET FISH MEAL MIX

Ideal for fishing for smaller coarse fish like roaches, bleaks and rudds. Fine structure with little amount of fishmeal. This very sweet groundbait with little activity, doesn't produce a big cloud and keeps the fish next to the ground. Also very catchy during the cold season. Can be combined with other groundbait mixes very well.

Art.-No.	Description	Content kg
13300-009	sweet fish meal mix	1



ADVANTAGE HOOKBAIT

Designed as hook bait for feeder and float fishing. Thanks to the light buoyancy of this special bait, the fish can soak in the lure with the hook without any suspicion. The elastic baits can be used with bajonett or pellet strap or even be fixed directly on the hook.

Available in four colors (flavors) and two sizes each in every box – 6/8mm and 8/10mm.

ORANGE



Art.-No.	Description	Ø mm	Content g
13300-100	orange	6/8	30
13300-101	orange	8/10	30

NATURAL



Art.-No.	Description	Ø mm	Content g
13300-102	natural	6/8	30
13300-103	natural	8/10	30

YELLOW



Art.-No.	Description	Ø mm	Content g
13300-104	yellow	6/8	30
13300-105	yellow	8/10	30

RED KRILL



Art.-No.	Description	Ø mm	Content g
13300-106	red krill	6/8	30
13300-107	red krill	8/10	30

The various options of Advantage hook baits.



2 sizes per box



Bajonett at the round side.



Pellet stripe at the shallow side.



ADVANTAGE BAIT BUCKET

Classical groundbait bucket with 18l or 12l capacity. The 18l bucket is delivered with lid. Due to the bright surface the Advantage bucket does not heat up that fast and the groundbait keeps its optimal consistence without remoisturizing.



ADVANTAGE BAIT BUCKET

M-SIZE

Art.-No.	Size	Height cm	Ø cm	Volume l
13305-305	M	20.1	29.5	12.0



ADVANTAGE BAIT BUCKET

L-SIZE | WITH LID

Art.-No.	Size	Height cm	Ø cm	Volume l
13305-300	L	27.1	37.0	18.0







Daiwa Germany GmbH

Georg-Brauchle-Ring 23-25
80992 München
Tel. +49 (0)89 / 309 065-0

info@daiwa.de
<https://www.daiwa.de>





G L O B E R I D E



A Lifetime Sports Company

THE GLOBERIDE Inc. INTERNATIONAL GROUP

Globeride Inc., Tokyo, Japan.

Daiwa Corporation, California, USA.

Daiwa (Australia) Pty. Ltd., Sydney, Australia.

Daiwa Enterprise Ltd., Taichung, Taiwan.

Daiwa France S.A.S., Rouen, France.

Daiwa Sports Ltd., Wishaw, Scotland, UK.

Daiwa Italy S.R.L., Milano, Italy.

Daiwa Asia (HK) Ltd., Hong Kong, China.

Daiwa Sports (Guangzhou) Co. Ltd.

Daiwa Korea Co. Ltd., Seoul, South Korea.

Singapore Daiwa Pte. Ltd., Singapore.

